



Aquatics

SUPERVISION

A leader's guide to youth swimming and boating activities



BOY SCOUTS OF AMERICA®

Aquatics Supervision

A Leader's Guide to Youth Swimming and Boating Activities

A Word About Youth Protection

Child abuse is a serious problem in our society, and unfortunately, it can occur anywhere, even in Scouting. Youth safety is of paramount importance to Scouting. For that reason, the BSA continues to create barriers to abuse beyond what have previously existed in Scouting.

The Boy Scouts of America places the greatest importance on providing the most secure environment possible for our youth members. To maintain such an environment, the BSA has developed numerous procedural and leadership selection policies, and provides parents and leaders with numerous online and print resources for the Cub Scout, Boy Scout, and Venturing programs.

The BSA requires Youth Protection training for all registered leaders.

New leaders are required to complete Youth Protection training. To take the training online, go to my.Scouting.org and establish an account using the member number you receive when you register for BSA membership. If you take the training online before you obtain a member number, be sure to return to MyScouting and enter your number for training record credit. Your BSA local council also provides training on a regular basis if you cannot take it online. For more information, refer to the back of the BSA adult membership application, No. 524-501.

Youth Protection training must be taken every two years—regardless of position. If a volunteer does not meet the BSA's Youth Protection training requirement at the time of recharter, the volunteer will not be reregistered.

We encourage all adults, including all parents, to take the BSA's Youth Protection training.

To find out more about the Youth Protection policies of the Boy Scouts of America and how to help Scouting keep your family safe, see the *Parent's Guide* in any of the Cub Scouting or Boy Scouting handbooks, or go to <http://www.scouting.org/Training/YouthProtection.aspx>.

Revised October 2011

Table of Contents *Continued*

Ocean	64	Beach Entry	100
Swimming From Boats	69	Noncontact Rescue	100
Distance and Competitive Swimming in Open Water	70	Contact Rescue	100
Guarded Public Facilities	71	Ease-In Entry	100
Remote Swimming Area Setup	72	Compact Jump	100
Recap	74	Stride Jump	101
Chapter 8: Basic Swimming Skills	75	Approaches	101
Crawl Stroke	76	Noncontact Assists for Conscious Subjects	102
Breaststroke	77	Accompanied Rescue	102
Elementary Backstroke	78	Noncontact Tow	103
Sidestroke	79	Shallow-Water Assist	103
Feetfirst Surface Dive	80	Aftercare for a Conscious Victim	103
Headfirst Surface Dive	81	Contact Rescues for Unconscious Victims	103
Nonswimmer Instruction	82	Wrist Tow (for Front Approach)	104
1. Orientation and Adjustment to Water	83	Armpit Tow (for Rear Approach)	104
2. Breathing	83	Submerged Victims	105
3. Body Position and Buoyancy	84	Landing an Unconscious Victim	106
4. Prone Float and Glide	84	Beach Drag	106
5. Back Float and Glide	85	Vertical Lift	106
6. Flutter Kick	85	Backboard Lift	106
7. Arm Movement	86	Aftercare for an Unconscious Victim	107
8. Coordination	86	Missing Submerged Victims	107
9. Turning Over	86	Contact Rescues for Conscious Victims	108
10. Turns, Reverses, Stops, and Starts	86	Defenses	108
11. Jump Entry Into Deep Water	87	Wrist Escape	108
Stroke Refinement	87	Rear Head-Hold Escape	108
Chapter 9: Water Rescue	89	Front Head-Hold Escape	109
Victim Recognition	90	Stabilization of Spinal Injury Victims	109
Surveillance Signals and Response	90	Head and Chin Support	109
Tired Swimmer	91	Head Splint	110
Distressed Swimmer	91	Line and Tender	111
Active Drowning Victim	91	Chapter 10: Safety Team Preparation	113
Unconscious Victim	92	Surveillance	114
Injured Victim	92	Communication	117
Endangered Swimmer	92	Emergency Action Plans	118
Rescue Techniques	93	Safe Swim Defense Kits	119
Reaching Rescues	94	Tailgate Review	120
Throwing Rescues	95	Chapter 11: The Underwater World	121
Rowing Rescues	97	Mask Selection and Fit	122
In-Water Assists Procedures	98	The Snorkel	123
In-Water Assists	100	Fins	123
Entries	100	Vest	124
		Dive Flag	124

Table of Contents *Continued*

Accessories	124	Chapter 14: Cold-Water Survival	157
Snorkeling Skills	124	Be Prepared	157
Diver Signals	127	Prevent	158
Dive Physics	128	Assess	159
Snorkeling Safety	129	Treat	159
1. Qualified Supervision	129	Self-Help	160
2. Personal Health Review	129	Chapter 15: Boating Basics	161
3. Safe Area	129	Boating Terminology	161
4. Proper Equipment	130	Hull Forms	162
5. Response Personnel (lifeguards and lookout)	131	Boat Stability	163
6. Ability	131	Rules of the Road	165
7. Buddy System	131	Signs, Markers, and Navigation Aids	166
8. Discipline	132	Boats and the Law	167
Scuba	132	Registrations	167
BSA Scuba Policy	133	Accident Reporting	167
Review Questions for Section II	135	Operator License	167
		Use Permits	167
		Signaling Equipment	167
		Chapter 16: Canoeing Skills	169
		Canoeing Activities	169
		Learning to Paddle	170
		Choosing a Paddle	171
		Launching the Canoe	172
		Paddling Positions	173
		Forward Stroke Overview	174
		Forward Stroke Components	175
		Paddling in a Straight Line	176
		Stern Correction Stroke	176
		Draw and Pry	177
		Moving Sideways	178
		Sweeps	178
		Turns and Pivots	179
		Stopping and Moving Backward	180
		Landing	180
		Rescue of a Distressed Swimmer	180
		Swamped Boat Drill	180
		Canoe-Over-Canoe Recovery	181
		Deepwater Entry	182
		Portaging	184
		Chapter 17: Kayaking Skills	185
		Kayak Designs	186
		Parts of the Kayak	188
		Learning to Paddle	188



Section III – Boating Skills and Safety

Chapter 12: Safety Afloat	145
1. Qualified Supervision	146
2. Personal Health Review	146
3. Swimming Ability	146
4. Life Jackets	147
5. Buddy System	147
6. Skill Proficiency	147
7. Planning	148
8. Equipment	149
9. Discipline	150
Chapter 13: Life Jackets	151
Designs	152
Type I—Offshore Life Jacket	152
Type II—Nearshore Buoyant Vest	152
Type III—Flotation Aid	152
Type V—Special-Use Device	153
Type IV—Throwable Devices	153
Size	153
Fit	154
Condition	154
Dynamic Strength Testing	155
Statistics	156

Table of Contents Continued

Paddles	188	Standing Waves	216
Boarding	189	Eddies	216
Capsize Drill	190	Pillows and Pour-Overs	217
Balance	190	Holes	217
Opening Exercises	191	Drops	217
The Forward Stroke	192	Shoals	217
Forward Sweep	192	International Scale of River Difficulty	218
Reverse Sweep	193	Class I: Easy	218
Rudder	193	Class II: Novice	218
Draw Stroke	193	Class III: Intermediate	218
Back Stroke	194	Class IV: Advanced	219
Stroke Combinations	194	Class V: Expert	219
Aiding a Capsized Paddler	194	Class VI: Extreme and Exploratory	219
Kayak-Over-Kayak Assist	195	Whitewater Gear	219
Additional Skills	195	Paddling Skills	220
Chapter 18: Stand Up Paddleboarding	197	Whitewater Strategy	221
Equipment	198	Whitewater Rafting	222
Learning to Paddle	199	BSA High-Adventure Bases	224
Board Positions	199	Chapter 21: Float Trip Preparation	225
Forward Stroke	200	Researching a Location	226
Going Straight	201	Who to Take Where	227
Turning and Stopping	201	How Far in How Long?	227
Beyond the Basics	201	Gear: What, From Where, at What Price	228
Falls and Recovery	202	How to Get There: People, Boats, and Shuttles	228
Other Safety Concerns	202	Float Plan	230
Chapter 19: Paddling on Flowing Water	203	What to Take	231
River Basics	204	Paperwork: Group and Individual	231
Strainers	205	Boats	231
Undercut Cliffs	205	Group Equipment and Provisions	231
Low-Head Dams and Horizon Lines	205	Personal Gear	232
Current Measures	206	How to Pack	232
Sideslips	207	On the Water	233
Ferries	208	Sample Float Plan	234
Fast or Slow?	208	Chapter 22: Rowing	235
Eddies	209	Boat Design	236
River Signals	210	Oars	237
Self-Rescue	211	Oarlocks	238
Boat Assists	212	Moving Forward	239
Throwing Assists	213	Moving Backward	240
Tubing	214	Stops, Turns, and Pivots	241
Chapter 20: Whitewater	215	Rowing Tips	241
Closed V	216	Swimmer Assists	242
Open V	216		

Chapter 23: Sailing	243
Small-Boat Programs	244
Professionally Crewed Day Trips	244
Captained Charters	245
Bareboat Charters	245
Cruising Checklist	246
Chapter 24: Boardsailing	249
The Board	250
The Rig	251
Moving to the Water	253
Uphauling	254
Getting Under Way	255
Steering	256
Turning Around	257
Tacking	258
Points of Sail	259
Stopping	260
Emergencies	260
Know the Environment	261
Safety Guidelines	262
What Next?	262
Chapter 25: Motorboating	263
Basic Powerboat Operation	266
Trailer	266
Getting Under Way	267
Planing	268
Turning	269
Waves and Wakes	269
Stopping	269
Personal Watercraft	270
Four-Cycle Outboards	270
Chapter 26: Tow Sports	271
Water-Skier's Safety Code	273
Role of the Observer	274
Boat Driver's Safety Code	274
Safe Boat Maneuvers	275
Towed Flotation Devices (Tubing)	276
"Skier Down" Flags	277
Unauthorized Activities	277
Review Questions for Section III	278



Section IV – Program Delivery

Appendix 1: Council Aquatics Committees	287
Organization	288
Responsibilities	288
Key Activities	288
Training	288
Program	289
Advancement	289
Safety	290
Attraction, Development, and Retention of Aquatics Leadership	290
Appendix 2: Merit Badge Counselors	291
The Aims of Scouting	292
What Is Advancement?	292
What Is a Merit Badge?	292
Why Does the BSA Use Merit Badge Counselors?	292
What Is a Merit Badge Counselor?	292
Merit Badge Counselor Requirements and Registration	293
The Merit Badge Process	293
Counseling Techniques	294
Summer Camp Merit Badge Counselors	294
Resources for Merit Badge Counselors	295
Appendix 3: Requirements and Application Forms	297
Kayaking BSA Application	298
Snorkeling BSA Application	299
Scuba BSA Application	301
Mile Swim BSA Application	303
BSA Stand Up Paddleboarding Application	305
Boardsailing BSA Application	307
Whitewater Rafting BSA Application	309
BSA Aquatics Supervision: Swimming and Water Rescue	311
BSA Aquatics Supervision: Paddle Craft Safety—Basic	312
BSA Aquatics Supervision: Paddle Craft Safety—River	313
BSA Lifeguard	314

Introduction to BSA Aquatics

Section





Qualified Supervision: Roles and Responsibilities of Unit Leaders

All program divisions of the Boy Scouts of America, from Cub Scouting through Venturing, use responsible outdoor adventure programs to promote character development and values-based leadership training. Activities in and on the water constitute a large subset of the programs that attract youth to and retain youth in the movement. Millions of youth participate yearly in aquatics activities during BSA outings under the leadership of more than a million adult volunteers.

The Scouting program is delivered through small local groups led by volunteers and sponsored by local civic clubs, churches, schools, and other organizations. Those groups, known generically as units, vary in size and name depending on the age of the youth being served. Units within a geographic division, or district, are assisted by professionals employed by a council. Individual units often take advantage of council summer camps where trained staff members assume the responsibility for quality program delivery, but many units also conduct aquatics activities under their own leadership. Youth camps conducted by other organizations are often standalone programs limited to a short duration in the summer. BSA camps are simply one element of a year-round unit program. The BSA encourages unit aquatics initiatives, whether it is a den leader taking advantage of a parent's offer of a backyard pool, or a crew taking off on its own Boundary Waters canoe trek from a Northern Tier National High Adventure base camp.

A key to safe, effective unit aquatics activities is informed and conscientious unit leadership. Serious mishaps during BSA events are rare. Although various aquatics activities can involve some degree of risk, those risks are mitigated by the training and commitment of BSA volunteer leaders. Properly conducted swimming and boating programs are safe as well as fun, exciting, and rewarding.

According to BSA guidelines:

All swimming and activity afloat must be supervised by a mature and conscientious adult age 21 or older who

- understands and knowingly accepts responsibility for the well-being and safety of youth members in his or her care,
- is experienced in the particular activity,
- is confident in his or her ability to respond appropriately in an emergency, and
- is trained and committed to the nine points of BSA Safety Afloat and/or the eight points of Safe Swim Defense.

The den leader, Cubmaster, Scoutmaster, or crew Advisor who accompanies the unit on an outing is always responsible for the first and last bulleted points. However, BSA policies do not specify that the unit leader must be the one who satisfies all of the above criteria. Under appropriate circumstances, the unit leader may delegate responsibil-

ity to others. For example, a Scout troop at a water park with trained lifeguards on duty need not assign separate unit personnel to perform water rescue. A Venturing crew on a whitewater excursion may rely on a licensed outfitter to provide the necessary equipment and trained guides.

As the above examples demonstrate, a unit can participate in fun and challenging aquatics activities even if unit leaders lack the knowledge and skill to conduct the activity themselves. On the other hand, a troop on its way to a jamboree need not forgo the use of a hotel pool just because the facility does not employ a professional lifeguard, provided unit leaders are properly prepared.

This publication provides the unit leader with information needed to determine when proper safeguards are in place for a unit aquatics activity, whether those safeguards are provided by a facility operator or the unit itself. Basic skills needed by the unit to function on its own are reviewed, as well as what to look for in a facility or operator.

After a review of this material, the unit leader should be confident in his or her ability to judge when an aquatics activity is safe, when the risk is unacceptable, or when his or her background is insufficient to make that determination. Experienced, informed leaders often develop a sixth sense or intuition with regard to an action. When an activity exceeds the leader's comfort zone, it should be curtailed or modified.





Chapter

2

BSA Aquatics: A Wealth of Opportunities

A review of program opportunities is appropriate before discussing how to conduct those activities safely. This information also provides a basic Scouting background for volunteers whose aquatics training is from other agencies. Probably no other organization offers its members the range of aquatics pursuits that Scouting offers. Scouting tailors these programs to match the maturity of the youth in various divisions, from Tigers in the first grade through 20-year-old coed Venturing members.

All aquatics program activities comply with BSA *Safe Swim Defense* and *Safety Afloat* standards, which will be covered extensively in the following chapters. Most of the aquatics activities also require the Scout to pass a basic 100-yard BSA swimmer classification test. Therefore, teaching the nonswimmer to swim is of primary importance, both for safety and to give the youth member the opportunity to participate with his/her peers in all aspects of the program.

Cub Scout Aquatics Programs



The basic Cub Scout unit is a **den** of six to eight Cub Scouts served by an adult den leader. Dens are organized into **packs** under a Cubmaster. Cub Scouting is the largest Scouting division with more than 1.4 million members.

The Cub Scouting program is based on age or school year. All new members first complete the Bobcat orientation program. However, a child in the third grade who joins Scouting begins the program at that stage without completing the first- and second-grade modules.

Children in the first, second, and third grades work on Tiger, Wolf, and Bear badges. Cub Scouts in the fourth and fifth grades undertake more advanced activities while working on the Webelos and Arrow of Light ranks.

Cub Scouts experience a series of adventures either individually with their family or as part of their den. There are required adventures for each badge plus electives. Each badge has an elective adventure that focuses on swimming and boating skills and safety.



Tiger:
Floats and Boats



Wolf:
Spirit of the Water



Bear:
Salmon Run



**Webelos,
Arrow of Light:**
Aquanaut



Immediately after completing an adventure, the Cub Scout is presented with the appropriate belt loop or pin.

Swimming is an important life skill. Children may be introduced to the water as toddlers, or even younger, but they don't become proficient at swimming until later. The early school years are a good time to teach children to swim, either individually by a knowledgeable parent or in a group with a qualified instructor. Since a single set of lessons typically does not impart the desired water competency, it is important to continue instruction and closely supervised activities until comfort in the water approaches that of walking. Cub Scouts whose dens consistently choose the water electives will be well served. Tigers hold their breath in a prone glide, Wolves swim for 25 feet in shallow water, Bears attempt the BSA beginner swimming classification in deep water, and Webelos attempt the 100-yard BSA swimmer classification. Basic water safety and rescues are also progressively addressed.

Den leaders who lack confidence in their ability to conduct the water adventures should first review the meeting plans in the den leader guide. Cub Scouts who have taken Red Cross, YMCA, or other formal swimming lessons should already have the basic swimming skills. Den leaders may also seek guidance from their local council aquatics committee. That committee may help arrange learn-to-swim opportunities for dens and may also help districts incorporate water adventure elements into Cub Scout day and resident camps. (If your council lacks such a committee, see Appendix 1.)

Scouts BSA Aquatics Programs



A youth can join a Scouts BSA **troop** after completing the fifth grade and may continue with the program through age 17. Troops are served by adult Scoutmasters and are subdivided into **patrols** of eight to 10 under youth leadership. Scouts BSA advance in rank from Tenderfoot to Eagle Scout. Recognition is achieved by meeting standards of performance. That is in contrast to the Cub Scouting program where youth are rewarded for "doing their best," or some outside sports programs with an emphasis on competition. Each Scout progresses through the ranks in order.

For Scouts BSA, both Second Class and First Class ranks require demonstration of basic swimming skills and

aquatics safety. Those requirements are found in the *Scouts BSA Handbook*. To advance to Eagle Scout rank, a Scout must know how to swim.

Specialty skills are learned by earning merit badges that also count toward rank advancement. There are several aquatics merit badges, described below. Each of those requires the Scout to first pass the BSA swimmer classification test. Troops should arrange for basic swimming instruction so that Scouts are able to meet the Second and First Class rank requirements and continue with the aquatics merit badges. Instruction can be done at the troop level by working directly with individual Scouts or arranging for them to enroll in various learn-to-swim programs. Some districts offer winter programs that include basic swimming instruction. All troops have access to council summer camp programs where basic swimming instruction is offered and tied to rank requirements as an incentive.

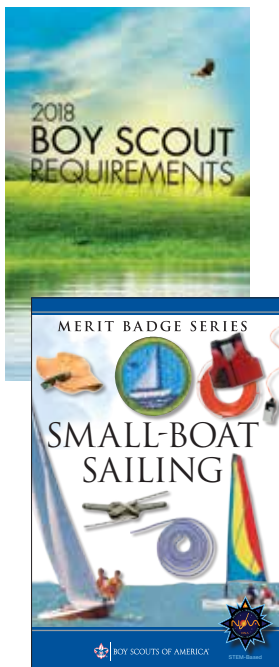

Merit Badges

Scouts earn merit badges by working with an approved counselor registered with the BSA. Scouts are connected with counselors through their Scoutmaster. Adults wishing to serve as counselors should review Appendix 2 and contact a Scoutmaster or the council office. Pamphlets for each merit badge list requirements and performance standards. Counselors are expected to present and evaluate the skills as specified in those pamphlets. Counselors are often aware

of alternative or advanced techniques. However, merit badge material is specifically designed for those of Scout age and serves as an introduction to a subject requiring basic skills rather than professional expertise. Merit badge material is reviewed regularly. Scouts and counselors should check that they have the most recent pamphlet by comparing the requirements with those in the *Scouts BSA Requirements* booklet published annually. Since special equipment is required for some of the aquatics merit badges, Scouts earn many of them when the troop attends a weeklong summer camp with trained counselors on-site. However, all merit badges may be earned year-round by a Scout and a buddy working with a counselor.



The **Swimming** merit badge, with more than 73,000 earned each year, is among the most popular, second only to First Aid. Requirements include proficiency in several strokes as well as associated swimming and safety skills. Many children learn the basics of swimming at an early age but stop formal lessons before becoming proficient in the strokes. The Swimming merit badge polishes the skills needed for a person to be competent, and confident, in the water. The Swimming, Hiking, or Cycling merit badge is required for Eagle Scout rank.



The **Lifesaving** merit badge teaches the Scout a progression of water-rescue techniques. It is one of the few remaining programs in the United States that prepares an individual to deal with the range of emergency situations likely to be encountered inadvertently in and around the water. Some prominent water-safety organizations offer basic water-rescue courses to the general public that stop short of in-water rescues, which are essential for a victim on the bottom of a backyard pool. Those organizations do teach in-water rescues to lifeguards, but lifeguards have specific equipment, a known area, and backup that a lifesaver

happening on a scene may lack. The need for a complete water-rescue course, even for those of Scout age, is easily demonstrated. Each year, the BSA awards roughly a hundred medals to Scouts and Scouters of all ages, including Cub Scouts, who rescue people from drowning. Those rescues are reported by active members. Rescues performed by the millions of former members are not as easy to track. Many of those performing rescues have not earned the Lifesaving merit badge, which is one reason basic water-rescue techniques are discussed throughout the program rather than only for this specific badge. BSA members of all ages do encounter situations where their actions are critical for saving lives. Most children faced with a friend or sibling in danger will attempt some action. The BSA strives to give youth the tools needed to make proper decisions in such circumstances. The BSA also tracks drownings that occur during Scouting functions. For decades, there have been no incidents of a Scout drowning while attempting to save another. Rescuer

safety is a major emphasis of the program. A Scout must earn either the Lifesaving or the Emergency Preparedness badge for the Eagle rank. More than 26,000 Lifesaving merit badges are earned yearly.



The **Canoeing** merit badge is designed to provide a Scout with tandem and solo skills to safely and efficiently travel on flat water. More than 33,000 are earned yearly.



The **Whitewater** merit badge extends skills learned in earning the Canoeing badge to cover Class I and Class II flowing water. The requirements may be completed using kayaks or rafts as well as canoes. Because special equipment, settings, and instruction are required, this merit badge is not accessible to as many Scouts, with just over 3,000 earned yearly.



The **Rowing** merit badge covers basic rowing techniques applicable to conventional and sliding-seat rowing. Although craft designed and equipped for rowing are not that common, this remains a popular merit badge, particularly at summer camps. More than 11,000 are earned yearly.



The **Small-Boat Sailing** merit badge gives an introduction to basic sailing techniques and seamanship. More than 17,000 are earned yearly.



The **Motorboating** merit badge covers basic boat handling and safety. Scouts are not allowed to operate a motorboat without a counselor on board and must adhere to state regulations that sometimes mandate additional age and skill requirements. More than 11,000 are earned yearly.



The **Water Sports** merit badge requires basic skills in either waterskiing or wakeboarding, and has replaced the Waterskiing merit badge. More than 3,000 are earned per year.



The **Scuba Diving** merit badge requires the Scout to first earn the Swimming merit badge and to then obtain Open Water Diver Certification from a diver training agency recognized in Scouting's policy on scuba. This high-adventure, environmental awareness program sets the stage for lifelong recreational and professional pursuits. More than 6,000 have been earned since the merit badge was introduced in 2009.



The **Kayaking** merit badge teaches basic kayaking skills and safety for calm water. Those skills support the very popular use of kayaks for recreational activities and also serve as a lead-in to advanced paddle sports such as sea/touring and whitewater kayaking. It was introduced in 2012 and rapidly became one of the most popular outdoor merit badges with 36,000 earned in 2013.

Venturing Programs



Venturing is for young men and women ages 14 to 20, or 13 with completion of the eighth grade, and has nearly 200,000 participants. The program is focused on four content areas: adventure, leadership, service, and personal growth. Leadership of a

Venturing **crew** is provided by the members under consultation with adult Advisors. Venturers may earn the Venturing, Discovery, Pathfinder, and Summit awards. Crews may undertake various high-adventure treks such as wilderness canoeing, whitewater rafting, sailboat cruising, and scuba diving. Aiding them in such efforts is a network of BSA high-adventure bases.

Sea Scouting



Sea Scouting is a specialized program for older youth with an emphasis on boating skills and maritime heritage. Sea Scout units, called **ships**, focus on cruising sailboats or power vessels. While many ships are near the coast, others are based on inland waters. During the boating season, Sea Scouts learn to maintain and operate their vessel, with a focus on learning safe and proper handling. Sea Scouts also learn the meaning of buoys and lights, how to take advantage of wind and tide, and how to drop anchor or approach a dock. Most ships hold formal meetings conducted in full dress or work uniforms. Swimming, lifesaving, first aid, Coast Guard Auxiliary Sailing and Seamanship, and cardiopulmonary resuscitation courses are taught by ship youth and adult leaders. State safe-boating courses are often included in the program. Members may work on advancement culminating in the Quartermaster Award. The U.S. Coast Guard provides a recognition certificate for those who earn that award. Learn more about Sea Scouting at www.seascout.org.

Special Aquatics Awards

Several BSA aquatics activity awards, not tied to advancement, promote water safety and are available to Boy Scouts and Venturers but not Cub Scouts. The various pieces of support material for each award, such as cards, patches, and fliers, are listed at the end of this chapter. Much of the material covering skills for the awards is presented in this publication, and application forms are provided in Appendix 3.

In Scouting, the emphasis is on programming for youth. However, some of these awards promote important skill and safety information that will help a unit leader conduct a safe unit activity. Therefore, these awards may also be earned by unit leaders and other registered volunteers (collectively known as Scouters). Often, training sessions are more effective when conducted separately for different age groups, but in some situations it is more practical for unit leaders to attend the same training sessions as unit members. Generally, Scouts should be given priority over Scouters when equipment is limited.



Mile Swim BSA. This award promotes physical fitness as well as confidence. Several training and conditioning sessions culminate in a continuous mile-long swim in safe conditions. The distance can be covered in a pool or in open water.

Policies for distance swimming in open water are covered in detail in the Safe Swim Defense discussion in Chapter 6. Although the Mile Swim recognition is designed to build stamina, anyone who has mastered restful swimming strokes such as the elementary backstroke, the sidestroke, or the restful breaststroke should be able to complete the distance with ease. There is no time limit for completing the swim.



Snorkeling BSA. This award encourages the development of basic skills using a mask, snorkel, and fins. The requirements must be completed in clear, confined water. Snorkeling BSA skills are prerequisites to unit snorkeling activities in open water.



Such activities are covered by Safe Swim Defense and similar guidelines in BSA Snorkeling Safety, reviewed in Chapter 11 with a presentation of the skills.



Scuba BSA. In earning this award, Scouts and Scouters get an introductory scuba experience in clear, confined water conducted by a professionally trained scuba instructor. Venturing crews may take part in scuba certification courses and open-water dives under the guidelines of the BSA Scuba Policy in Chapter 11.



Kayaking BSA. This award recognizes the growing interest in kayaking both in the public and in Scouting. Kayaking BSA skills in Chapter 17 satisfy Safety Afloat training guidelines for kayaking excursions on calm water.



Boardsailing BSA. This award was introduced when boardsailing first became popular and remains a basic introduction to the sport. Skills necessary for the award are discussed in Chapter 24.



BSA Stand Up Paddleboarding.

This award, released to coincide with SUP programs at the 2013 National Scout Jamboree, provides basic skill and safety instruction for stand up paddleboarding in calm water. Look for requirements online at www.scouting.org and in Appendix 3 of this manual.



Whitewater Rafting BSA.

Many Scouting units participate in rafting trips conducted by outfitters or councils. This award recognizes the challenge and adventure of such activities. The award is available to BSA youth and adults who are members of Boy Scout, Venturing, or Sea Scout units. Requirements focus on safety and basic paddling skills on white water up to Class III. All instruction and skill completions are directly supervised by a professionally trained or licensed rafting guide. A qualified raft captain must be in each raft during the required trip. Participants help power and control the raft with paddles—simply riding in a raft rowed by a guide is not sufficient.



High-Adventure Aquatics Programs

More than 115,000 units are served by nearly 300 local councils, each of which operates at least one of the more than 400 organized BSA camping facilities. Almost all of the council camps offer basic programs in swimming, lifesaving, rowing, and canoeing. Some include sailing, kayaking, motorboating, and waterskiing. More than 50 percent of the camps offer units the option of some type of float trip, on or off council property. Some are simple overnight trips on flat water; others are weeklong excursions on flowing water.

The National Council has approved roughly 60 of the council camps as high-adventure bases with treks lasting five days or more. While some feature backpacking, others offer canoeing, kayaking, rafting, or sailing. Some offer scuba certification or other advanced skills as a resident program. Most will accept out-of-council troops, and several accommodate coed crews. A listing of the camps and their programs can be found at the national BSA website, www.scouting.org.

The BSA also operates four national high-adventure programs, several of which offer aquatics programs.



The Northern Tier National High Adventure Program (www.ntier.org) stages canoe treks from three base camps. As is the model for Scout camping in general, a troop or crew that meets year-round comes with its

own adult leadership, although occasionally a council may recruit a contingent from several units. Northern Tier normally provides a trained staff member to accompany inexperienced groups, but experienced units may elect to travel without guidance. Each summer, roughly 5,000 Scouts in groups of six to 11 take wilderness canoe trips lasting six to 10 days.

The Charles L. Sommers base camp near Ely, Minnesota, has been the starting point for trips into the Boundary Waters Canoe Area Wilderness since 1923. The camp operates a radio base station that forms an important part of the emergency response system for the area. Commercial outfitters often instruct their customers to contact a BSA crew in case of emergency. The Rogert base camp near Atikokan, Ontario, accesses Quetico Provincial Park from the Canadian side. A base camp in Bissett, Manitoba, stages treks into Atikaki Park via float plane to Scout Lake.



The Florida National High Adventure Sea Base (www.bsaseabase.org)

began operations in the 1970s and now runs two staging areas in the Florida Keys. The sea base operates one of the largest scuba programs in the United

States with roughly 1,500 participants yearly. While many participants seek scuba certification, those already certified may dive from boats stationed at the base or from live-aboard sailboats. Another 9,000 or so engage in

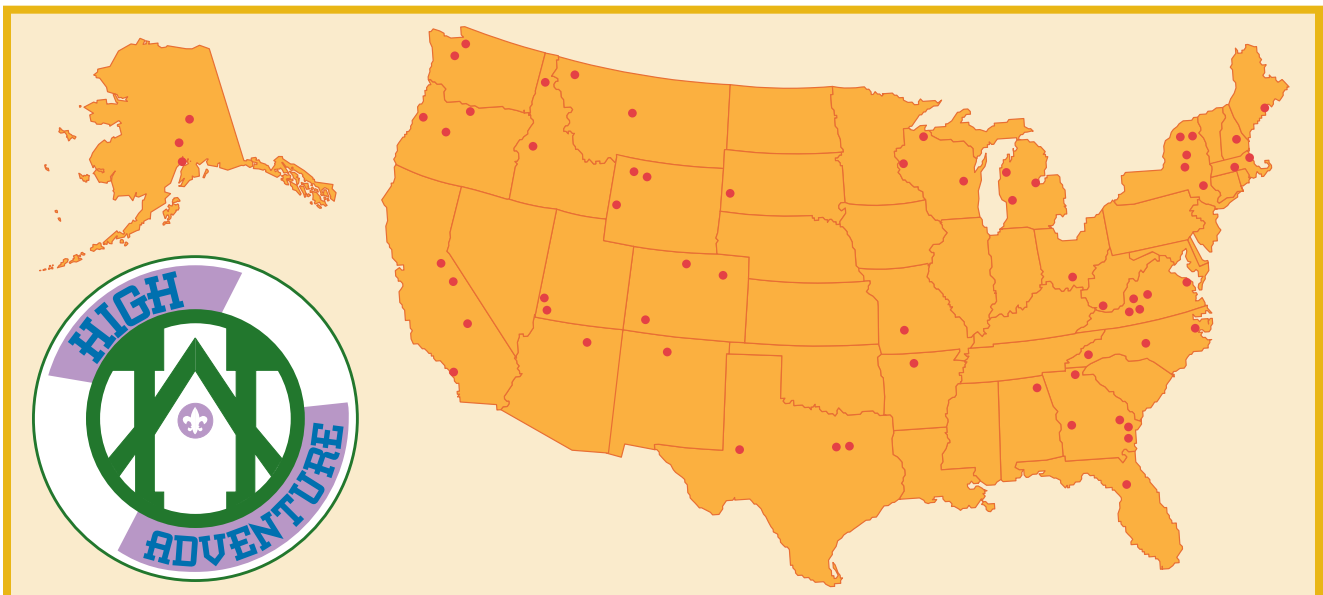

various boating activities. Some kayak to a 110-acre island owned by the base and camp Robinson Crusoe-style. Others sail the Keys and the Bahamas on live-aboard vessels.



The newest BSA national facility is the Summit Bechtel

Family National Scout Reserve in West Virginia. The Summit site includes the Paul R. Christen High Adventure Base and the James C. Justice National Scout Camp. The Summit is not limited to aquatics: It has world-class climbing, canopy tours, mountain biking, and other high-adventure activities. However, it is adjacent to the New River Gorge National River managed by the U.S. National Park Service. Because the New River Gorge is home to some of the world's best white water, whitewater programs are central experiences at the Summit.

Although Scouting offers units many exciting opportunities for high-adventure treks, units are not restricted to using only BSA facilities. Some units "go it alone" on yearly journeys down a local river. Others contract with commercial outfitters for equipment, supplies, and guides. The Northern Tier handles roughly half of the Scouting units traveling to the Boundary Waters each year, according to estimates. So long as Safe Swim Defense and Safety Afloat guidelines are followed by conscientious, trained leaders, units are encouraged to provide youth with exciting, challenging, age-appropriate opportunities for growth and leadership development.

National Jamborees



Every four years the National Council sponsors a national jamboree to which local councils send contingents totaling roughly 40,000 for a 10-day encampment. In 2013, the Summit was designated as the permanent site for the National Scout Jamboree. Initial jamboree

aquatics programs at the Summit included whitewater rafting, dragon boating, paddleboarding, kayaking, introductory scuba, and a water challenge course. Those programs will change as facilities are developed and interests evolve. The Summit will also host the 24th World Jamboree in 2019.

Training Programs for Adults (and Older Youth)

Such diverse and extensive aquatics programs mean the BSA must recruit and/or train volunteers to provide the program at the unit level, as well as professionals, full-time and seasonal, to assist units via camp operations. Several training options are available to registered adults and older youth to meet unit and summer camp staff needs.



Safe Swim Defense and Safety Afloat Commitment Training



Basic training introduces Safe Swim Defense and Safety Afloat procedures. The plans emphasize prevention but also cover emergency recognition and response. Such training is required whenever a unit goes swimming or boating. Awareness training for these policies may be provided by lectures or videos at various training events. Introductory training is also available at my.scouting.org. Unit leaders who attend summer camps are provided opportunities to practice the procedures with staff assistance.

Safe Swim Defense and Safety Afloat Skills Training



A simple introduction to rules and procedures should allow a conscientious leader to assess his/her readiness to conduct a unit aquatics activity. However, the policies suggest or mandate various skills that cannot be learned in a lecture or online. To fill that gap are two hands-on courses that provide the unit leader with basic skills. Aquatics Supervision: Swimming and

Water Rescue and Aquatics Supervision: Paddle Craft Safety provide in-depth training in Safe Swim Defense and Safety Afloat principles along with basic swimming, boating, and rescue skills. Situations requiring more advanced skills are reviewed, with sources for such training. These courses are highly recommended for unit leaders whenever a unit swims at a location without professional lifeguards or undertakes a boating expedition without a trained guide. This publication serves as the manual for the two courses. Requirements are given in Appendix 3. The courses are taught by authorized instructors following standardized guidelines.

BSA Lifeguard



For three-quarters of a century, BSA Lifeguard and its predecessor, Scout Lifeguard, served the needs of units and summer camps for water safety leadership training. Over that time, more and more programs requiring specialized skills, such as snorkeling and kayaking, have been added. The skills that define the standard of care for summer camp operations, such as spinal injury management, have also evolved. Those changes made it increasingly difficult to meet all the needs in a single course of reasonable duration. Therefore, the emphasis of BSA Lifeguard has changed. The primary purpose is no longer to give units the skills necessary to conduct safe swimming and boating activities. The two Aquatics Supervision awards in Swimming and Water Rescue and Paddle Craft Safety are designed to meet that need. The revised BSA Lifeguard program now focuses on the need to provide BSA-operated facilities, such as summer camps, with training that meets the requirements of government agencies for professional lifeguards at regulated swimming activities. The program is open to all registered adults and older youth and is a recommended adjunct to the Aquatics Supervision awards for unit leaders who wish to expand their water safety skills and for youth who wish to work on the aquatics staffs at BSA camps.

BSA Aquatics Instructor



BSA Aquatics Instructor is the highest level of training, achievement, and recognition for adults in Scouting aquatics. The training prepares adults for leadership roles in year-round aquatics programs and in summer camps. Topics include a review of the goals, requirements, policies, and procedures for all Scouting aquatics programs; basic skill review in swimming, lifesaving, and boating; how to teach those skills to participants of various ages; and how to manage the aquatics program at a BSA Cub Scout or Boy Scout camp facility. The training is offered only in conjunction with a BSA National Camping School. BSA regional offices typically conduct National Camping

School sessions in the early spring. Participants must be approved by their local council.

National BSA camp standards require that aquatics directors at BSA camps are 21 years of age or older, have current CPR and first-aid training, and have current BSA Aquatics Instructor training. However, BSA Aquatics Instructor training is available to those 18 or older. Councils are encouraged to send aquatics staff members who are below 21 years of age for Aquatics Instructor training to serve as assistant aquatics directors and to gain experience before becoming a camp aquatics director. Such a succession plan also makes it easier for councils to manage staffing needs.

Links to Other Organizations

The BSA recognizes that other organizations provide expertise in specialized activities such as waterskiing and works with those organizations to keep BSA aquatics programs up-to-date. In particular, the BSA National Council has agreements or understandings with the American Red Cross, the Professional Association of

Diving Instructors, the American Canoe Association, the United States Coast Guard Auxiliary, and United States Power Squadrons. Training provided by other organizations extends the base of volunteers with the necessary background to offer quality BSA programs. However, BSA programs are not simply copies of programs offered by other agencies. In areas such as Safe Swim Defense, the BSA is a recognized leader in the field. In other areas, such as scuba training, an instructor rating from an outside agency is required to offer the BSA programs. In that case, the BSA program may be more limited than similar programs offered by the instructor's certifying agency. Therefore, outside instructors need to become familiar with specific BSA policies and requirements before conducting activities for Scouts. This publication provides a useful overview, but activity-specific literature, such as merit badge pamphlets, should also be consulted. Also note that each merit badge pamphlet solicits suggestions for improvement and provides an address for sending comments.



Council Aquatics Committees

Few units have the resources to independently provide all of the programs listed above. Councils can give units additional opportunities by establishing a council aquatics committee to foster local programs, provide training, help recruit camp aquatics staff, and oversee council resources, such as establishing policies for units to use council canoes when camp is not in session. Additional information on aquatics committees is found in Appendix 1. A major goal of every

council aquatics committee is to see that every member of Scouting has both the opportunity and the encouragement to learn how to swim.

Robert Baden-Powell founded the international Scouting movement in 1907. His outlook on the importance of swimming ability follows:

Baden-Powell's Outlook on Swimming and the First Class Scout

"A boy does not really get the value of the Scout training until he is a First Class Scout. The Second Class rank is only a step to that standing. But it is a lamentable fact that a good many are content to remain as Second Class Scouts once they have gained a few badges of proficiency. It is primarily for that reason mainly, that the All Round Cords are now obtainable only by First Class Scouts. This move has been welcomed by Scoutmasters as giving an incentive to the lads to keep progressing in their training.



"Of course, the main objection to it is that it necessitates the boys learning to swim, and facilities for this do not exist in all centers. It has, therefore, been suggested in one or two cases that this rule should be relaxed. I am afraid that I have been very 'sticky' about it, and although I generally make things as elastic as possible, I may have appeared unnaturally obstinate in this one particular: but I had reasons, and experience has now shown those reasons were right.

"When a boy has become a First Class Scout—but not before then—he has got a founding in the qualities—mental, moral and physical—that go with making a good, useful man. And I look on swimming as a very important step, combining as it does attributes of all three of those classes. Mentally, it gives the boy a new sense of self-confidence and pluck; morally, it gives him the power of helping others in distress and puts a responsibility upon him of actually risking his life at any moment for others; and physically, it is a grand exercise for developing wind and limb.





"Every man ought to be able to swim; and in Norway and Sweden, the home of practical education, every boy and girl is taught swimming at school.

"The fact that swimming has got to be learned by the Boy Scout before he can gain his First Class badge has had the effect of putting the character of the lads in very many cases to a hard and strengthening test.

"At first they complained that there was no place near where they could learn to swim. But when they found this was not accepted as an excuse, they set to work to make places or to get to where such places existed. I have heard of boys riding five miles on their bicycles day after day to swimming baths; streams in many country places have been dammed up, and bathing places made by the Scouts; the summer camp has been established at some seaside or riverside spot for the special purpose of getting everyone trained in swimming.

"It can be done if everybody sets his mind to it. If the boys are put to extra trouble in bringing it about, so much the better for their character training. In any case, I look upon swimming as an essential qualification for First Class Scout, and for every man. Also, I don't consider a boy a real Scout till he has passed his First Class tests."

—Lord Baden-Powell, February 1914

<h1>Swimming and Boating</h1> <p>Age-Appropriate Guidelines (see text for complete criteria)</p>						
		Tigers (with adult partner)	Wolf/Bear Cub Scouts	Webelos Scouts	Boy Scouts	Older Scouts and Venturers
Learn-to-swim programs						
Recreational swimming		Divided by ability groups, only <i>Swimmers</i> in deep water				
Snorkeling in confined area		Divided by ability groups, only <i>Swimmers</i> in deep water				
Snorkeling in open water		⊘	⊘	⊘	Snorkeling BSA required	
Scuba BSA		⊘	⊘	⊘	Swimmers only	
Scuba diving in open water		⊘	⊘	⊘	Certification required	
Open-water distance swims		⊘	⊘	⊘	Swimmers only – Mile Swim safety criteria	
Triathlon (races in open water)		⊘	⊘	⊘	⊘	Sanctioned events only
Surfing		⊘	⊘	⊘	Swimmers only	
High board, platform, cliff diving		⊘	⊘	⊘	⊘	⊘
Commercial marine transport (ferries, cruise ships, etc.)						
Day rides on large private craft		Qualified adult operation, calm water, capacity of four or more. All ability groups.				
Crew member, overnight cruise		⊘	⊘	⊘		
Youth-operated small craft on calm, flat water:	Stable, fixed-seat rowboats and pedal boats	Nonswimmers and <i>beginners</i> buddied with swimmer in same boat.				
	Canoes, tandem kayaks, rafts	Nonswimmers and <i>beginners</i> buddied with adult swimmer in same boat.				
	Single-person kayaks	Swimmers only				
	SUP	Swimmers only				
	Rowing shells	⊘	⊘	⊘	Swimmers only	
	Sailboats	⊘	⊘	⊘	Swimmers only	
	Sailboards	⊘	⊘	⊘	Swimmers only	
	Powerboats (subject to state regulations)	⊘	⊘	⊘	Approved supervision on board, <i>swimmers</i> only	
Tubing on gently flowing water		Swimmers only				
Commercial trips on white water		⊘	⊘	⊘	Professional operator on board, <i>swimmers</i> only	
Small craft, youth-operated on white water: Class I and II		⊘	⊘	⊘	Swimmers only	
Small craft, youth-operated on white water: Class III		⊘	⊘	⊘	⊘	Only trained <i>swimmers</i>
Towed activities (water skis, wakeboards, floats)		⊘	⊘	⊘	Approved towboat operator, <i>swimmers</i> only	
Aerial towed activities (kites, parasails, etc.)		⊘	⊘	⊘	⊘	⊘
Personal watercraft (PWC)		⊘	⊘	⊘	⊘	Approved council training programs

Resources

Check with your council service center for these and other program and training aids.

Printed Materials, DVDs

Cub Scouting Program

<i>Tiger Handbook</i>	34713
<i>Wolf Handbook</i>	33450
<i>Bear Handbook</i>	33451
<i>Webeles Handbook</i>	33452
<i>Cub Scout Day Camp Administration Guide</i>	430-338

Scouts BSA Program

<i>Scouts BSA Handbook</i>	34554
<i>Swimming merit badge pamphlet</i>	35957
<i>Lifesaving merit badge pamphlet</i>	35915
<i>Rowing merit badge pamphlet</i>	35943
<i>Canoeing merit badge pamphlet</i>	35867
<i>Whitewater merit badge pamphlet</i>	35965
<i>Small-Boat Sailing merit badge pamphlet</i>	35950
<i>Motorboating merit badge pamphlet</i>	35920
<i>Water Sports merit badge pamphlet</i>	35963
<i>Scuba Diving merit badge pamphlet</i>	35969
<i>Kayaking merit badge pamphlet</i>	35702

Venturing Program

<i>Handbook for Venturers</i>	33494
<i>Sea Scout Manual</i>	33239

Number

Printed Materials, DVDs

Number

Additional Program Features

<i>Fieldbook</i>	34006
Kayaking BSA (card)	34208 (also online)
Snorkeling BSA (card)	34205 (also online)
Scuba BSA (card)	33143 (also online)
Mile Swim BSA (card)	34246
Boardsailing BSA Application	(in appendix)
50-Miler Award Application	430-067
Knots and How to Tie Them	33170

Safety Training

<i>Guide to Safe Scouting</i>	34416
Safe Swim Defense flier	34370
Safe Swim Defense DVD	AV-09DVD29
Safe Swim Defense commitment cards	34243
Safety Afloat flier	34368
Safety Afloat DVD	AV-09DVD02
Safety Afloat commitment cards	34242
<i>Aquatics Supervision</i>	34346
BSA Lifeguard instructor manual	34519
BSA Lifeguard pocket card	34672
<i>Reading the Rhythms of Rivers and Rapids</i> DVD	430-605

Websites

- www.scouting.org
- my.scouting.org
- www.ntier.org
- www.bsaseabase.org
- www.seascout.org
- www.summitbsa.org

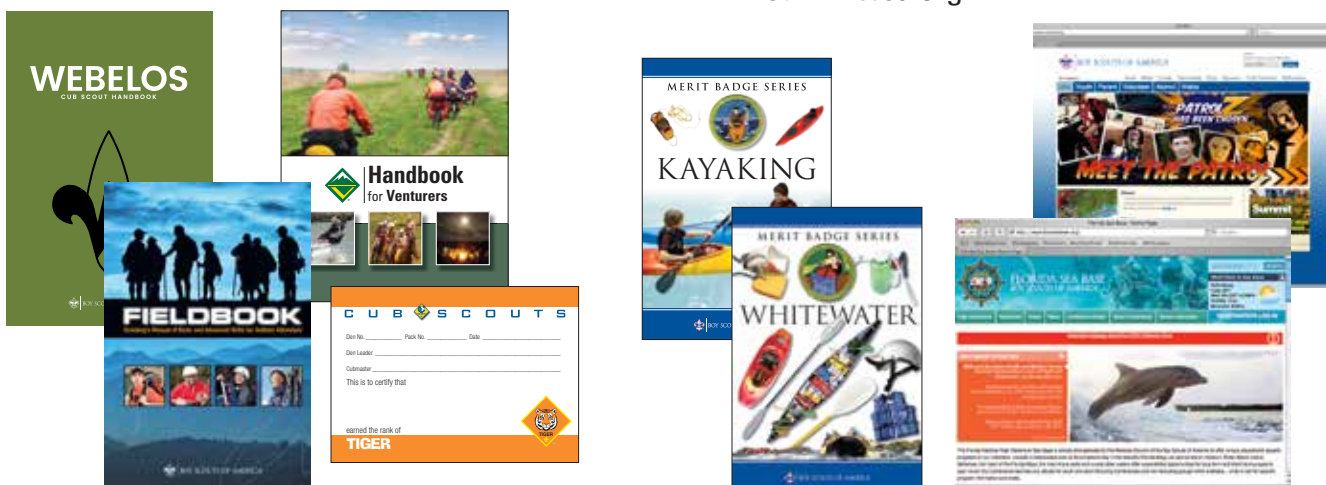



Safety First

Simple tasks can become risky if basic safety precautions are ignored, and apparently dangerous activities can be done with minimal risk with proper planning and safeguards. For any activity, several items foster safety. A review of common causes of accidents is a good place to start. With that knowledge, rules and procedures can then be established to avoid risky situations. **Prevention** is the first and most important safety consideration. Key components for prevention include the health and skill of participants, the safety of equipment and the environment, and the observance of rules and procedures (supervision and discipline).

Contingency plans are important in case an emergency does arise. Prompt recognition of a developing crisis is a nontrivial task that requires conscientious effort and a plan for adequate **surveillance** of everyone in the activity. The **buddy system** is used in Scouting to provide one-on-one observation to augment the scrutiny provided by the unit leader and rescue personnel. Appropriate response to an emergency is easier when a prearranged **emergency action plan** is implemented by those trained in relevant rescue skills.

The rest of this section will review common causes of drowning, introduce the basic elements of Safe Swim Defense and Safety Afloat procedures for drowning prevention, and outline the general elements of an emergency action plan for swimming and boating activities. The text will expand on rules and procedures, surveillance, emergency action plans, and rescue skills for specific activities at various sites. Should an emergency arise, water rescue is relatively safe and simple when care is taken to operate in a safe setting with appropriate rescue aids at hand. Even so, situations in which rescue skills are needed should be extremely rare. The overall safety of an aquatics activity or facility should be judged by the absence of crisis and rescue. If rescues are commonplace, inadequate precautions have been taken to ensure the highest safety standards, even if all the rescues are successful.

Millions of Scouts and millions more in the general public enjoy water sports year-round without any adverse experience. Water and people mix well when simple precautions are taken. However, not everyone realizes the need for such precautions. Each year, several thousand people drown in the United States. Thousands more are taken to emergency rooms due to water-related incidents, and not all of those people completely recover. Thousands of others are saved from injury by alert lifeguards or other rescuers.

“Drowning is an unlovely thing.”

—Wilbert Longfellow,
early BSA water safety consultant

Two unfortunate tragedies dramatically illustrate how the public at large sometimes underestimates the danger in a seemingly benign situation.

A mother arranged to chaperone a group of teenaged girls at an overnight stay at a hotel as a treat for her daughter’s birthday. While the group was using the hotel pool, the daughter, who could not swim, moved into water over her head. The mother noticed the daughter acting strangely and jumped into the water when the daughter did not respond to her calls. The mother, as her feet hit the bottom, managed to push her daughter a short distance to the side, where the other girls helped her out. With all their attention focused on the daughter, no one noticed that the mother, who also could not swim, could not move herself the short distance to safety. The mother drowned, unable to call for help.



Two well-meaning and conscientious adults took a newly formed youth group on an overnight campout. The campsite was near a small, slow-moving river, and the group waded into the water from a shallow sandbar. Two boys, who could not swim, stepped off the sandbar into the channel where the water was over their heads. They did not call out for help, submerged, and drowned without anyone realizing they were in peril.

Both incidents illustrate the “instinctive drowning response” first publicized by Frank Pia in the 1970s. True nonswimmers—that is, those who have never supported themselves in deep water—are often in danger as soon as they enter deep water. Such persons, from toddlers through adults, are unable to call for help and unable to move even a few feet to safety, whether safety is a pool side, the other side of a drop-off, or a flotation device they fell from. To an uninformed observer, such victims may even appear to be playing in the water.

Drowning in Perspective

- Nonswimmers are at risk in and near deep water; for example, floating on an air mattress.
- Drowning follows car accidents as the second leading cause of accidental death for Scout-aged youth.
- Males comprise roughly three-fourths of drowning victims.
- Drowning happens more often in warm-weather months.
- In some warm-weather states, deaths from drowning for 1- to 4-year-olds match those from car accidents.
- Most drownings of those ages 1 to 4 occur in residential pools.
- Relatively few drownings occur in pools where lifeguards are on duty. (Failure of the guard to notice the victim is a contributing factor in those cases.)

- Headfirst entry into the water contributes to sports-related spinal injuries.
- Many victims did not intend to enter the water. Drowning can result from falls, boating accidents, and cars entering the water.
- Floods are second only to fire as the most common natural disasters. Drowning is the main cause of flood-related deaths.
- Boating activities account for roughly one-fourth of all drownings.
- Most boating fatalities occur in small, open motorboats on inland waters due to capsize or falling overboard.
- Life jackets are not worn in more than 80 percent of fatal boating accidents.
- Alcohol is estimated as a contributing factor in 25 percent to 50 percent of swimming and boating fatalities.
- Cardiovascular disease is the No. 1 cause of death in the United States. Survival rates are affected when heart attacks and strokes occur in or on the water.

Drowning by the Numbers

Most deaths in the United States are from disease; however, for youth of Scouting age, deaths from injuries exceed those from disease. Also note that teenage suicide accounts for more deaths for that age group than any accidental cause other than vehicular accidents.

(Note log scale used to display large differences. Compare values rather than segment lengths.)

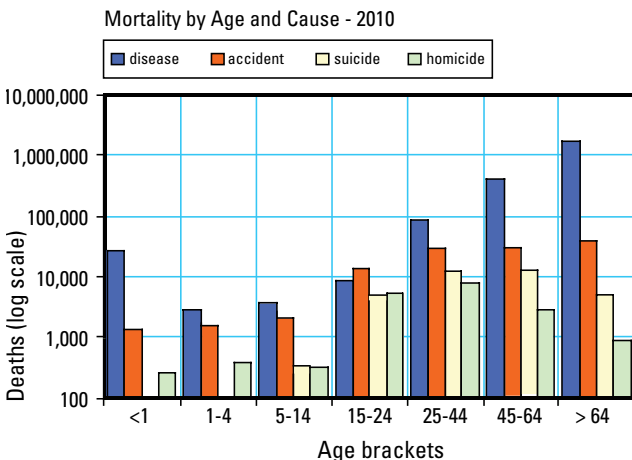

Accidental Deaths by Age and Cause - 2009

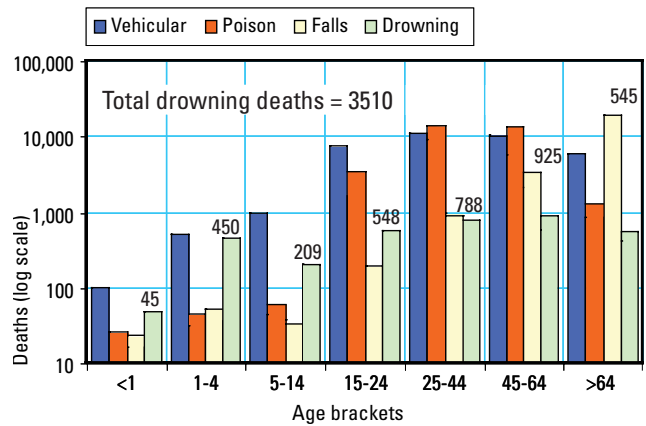

Overall, deaths from poison, suffocation, falls, and fires may exceed those from drowning, depending on the year and age bracket. For youth of Scouting age, drowning consistently ranks second behind vehicular accidents.

Accidental Deaths for 5 to 14-year-olds – 2009

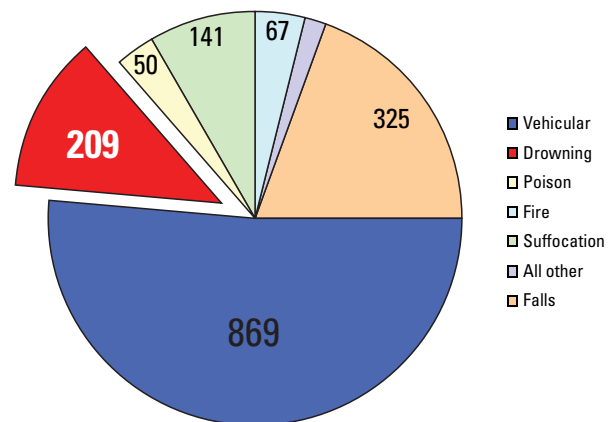

(Note that the CDC reports drowning from boating and other vehicular accidents separately from swimming incidents.)

Even though the percentage of deaths due to drowning may be small, the hundreds of easily preventable deaths demonstrate the need for increased water-safety awareness.

Such statistics can be combined with case studies to support the following reasons people drown. When one or more of these contributing causes of drowning are present, tragedy can result. Lack of attention to any one factor may result in inadequate regard for others. Fortunately, informed leadership can easily implement procedures to minimize the risk from each factor.



“Every Scout a swimmer” was an early slogan of the Boy Scouts of America. No other factor contributes more to the safety of an individual in the water than the ability to easily move through it. Unit leaders today should strive to meet the 1924 goal.

- **Poor swimming skills.** Many people who drown lack the skill to swim only a few feet to safety. Knowing how to swim is the best protection against drowning. Although poor swimmers can safely participate in shallow-water or near-shore activities, a conscientious BSA leader will encourage everyone in the unit to advance at least to the BSA “swimmer” level. Exhaustion is often cited as a factor in drownings when a poor swimmer overestimates his or her swimming ability. A swimmer who has learned restful swimming strokes seldom has that problem.
- **Medical complications.** Drowning can result when strokes, heart attacks, diabetic reactions, or seizures occur in the water. Such conditions can cause an otherwise good swimmer to become incapacitated. Prevention relies on medical screening. Supervisors should review the health histories of all participants and physicians’ recommendations. Special precautions may be needed for those with certain medical conditions.
- **Unsafe areas.** Unsafe situations for swimming and boating include swift water, submerged obstacles, ocean rip currents, high waves, and cold water. Even a simple drop-off is unsafe for a nonswimmer, which means extra precautions are needed for poor

swimmers engaged in water sports. Although it is often possible to determine that an area is unsafe simply by looking, confirming that an area is safe may take an underwater search of a swimming area or advanced scouting of a river.

- **Poor judgment.** Often, the skill of those taking part determines how safe an area or activity is. Participation in an unsafe activity reflects a lack of knowledge or judgment. Examples include overestimating swimming or boating skill, failing to wear a life jacket, diving into shallow water, and alcohol or other drug abuse. Education is one key to prevention. Rule enforcement is another.
- **Inadequate supervision.** A toddler left unattended near a pool is an example of inadequate supervision. Allowing youth groups to engage in unsafe activities is another. Qualified supervision and discipline provide protection.

Accident Prevention: Elements of Safe Swim Defense and Safety Afloat

Each of the above factors contributing to drowning is specifically covered by elements of the BSA Safe Swim Defense and Safety Afloat plans. The primary emphasis of each plan is prevention. **Qualified supervision** and **discipline** guard against unsafe activities and ensure that each point is properly implemented. A **personal health review** addresses medical complications. **Ability groups, swimming ability, and skill proficiency** match activities, areas, and equipment to abilities. **Safe swimming area, equipment, including life jackets, and planning** concern safe physical arrangements.

Each plan covers preparation, including recognition and response, should an accident occur. The **buddy system, lookouts, and response personnel** provide eyes and ears alert for trouble and ensure that someone is available to provide safe and effective assistance. They are integral parts of emergency action plans.

Safe Swim Defense and Safety Afloat are the backbones of safe unit swimming and boating activities. They define standard operating procedures for BSA water sports and the standard of care expected of unit leadership. The points are introduced here to show their close relationship to factors that lead to drowning. However, a simple listing does not provide sufficient information to actually implement the procedures. Each item will be fully explained in subsequent discussions.

Summary of Safe Swim Defense Guidelines



1. Qualified Supervision.

All swimming activity must be supervised by a mature and conscientious adult 21 or older who understands and knowingly accepts responsibility for the well-being and safety of those in his or her care, and who is trained in and committed to the eight points of BSA Safe Swim Defense.

2. Personal Health Review.

Require evidence of fitness for swimming activity with a complete health history from a physician, parent, or legal guardian. The adult supervisor should adjust all supervision, discipline, and protection to anticipate any potential risks associated with individual health conditions. In the event of any significant health conditions, an examination by a physician should be required by the adult supervisor.

3. Safe Area.

All swimming areas must be carefully inspected and prepared for safety prior to each activity. Water depth, quality, temperature, movement, and clarity are important considerations. Hazards must be eliminated or isolated by conspicuous markings and discussed with participants.

4. Response Personnel (Lifeguards).

Every swimming activity must be closely and continuously monitored by a trained rescue team on the alert for and ready to respond during emergencies.



5. Lookout.

The lookout continuously monitors the conduct of the swim, identifies any departures from Safe Swim Defense, alerts response personnel as needed, and monitors the weather and environment.



6. Ability Groups.

All participants are designated as swimmers, beginners, or nonswimmers based on swimming ability confirmed by standardized BSA swim classification tests. Each group is assigned a specific swimming area with depths consistent with those abilities.



7. Buddy System.

Every participant is paired with one other. Buddies stay together, monitor each other, and alert the safety team if either needs assistance or is missing.



8. Discipline.

Rules are effective only when followed. All participants should know, understand, and respect the rules and procedures for safe swimming provided by Safe Swim Defense guidelines. Applicable rules should be discussed prior to the outing and reviewed for all participants at the water's edge just before the swimming activity begins.



Summary of Safety Afloat Guidelines



1. Qualified Supervision.

All activity afloat must be supervised by a mature and conscientious adult 21 or older who understands and knowingly accepts responsibility for the well-being and safety of those in his or her care, and who is trained in and committed to the nine points of BSA Safety Afloat.



2. Personal Health Review.

All participants must present evidence of fitness by a complete health history from a physician, parent, or legal guardian. Adjust all supervision, discipline, and protection to anticipate any risks associated with individual health conditions. In the event of any significant health conditions, a medical evaluation by a physician should be required by the adult leader.



3. Swimming Ability.

Operation of any boat on a float trip is limited to youth and adults who have completed the standard BSA swimmer classification test. (Beginners and nonswimmers may participate in activities afloat only with the approval of the qualified supervisor in compliance with the complete text of Safety Afloat.)



4. Life Jackets.

Properly fitted U.S. Coast Guard–approved life jackets must be worn by all persons engaged in boating activity. Type III life jackets are recommended for general recreational use.



5. Buddy System.

All participants are paired as buddies who are always aware of each other's situation and prepared to sound an alarm and lend assistance immediately

when needed. Buddies either ride in the same boat or stay near one another in single-person craft.



6. Skill Proficiency.

Everyone in an activity afloat must have sufficient knowledge and skill to participate safely. (Skills appropriate for different situations are summarized in the complete text of Safety Afloat and reviewed elsewhere in this publication.)



7. Planning.

Proper planning is necessary to ensure a safe, enjoyable exercise afloat. All plans should include a scheduled itinerary, notification of appropriate parties, communication arrangements, contingencies in case of foul weather or equipment failure, and emergency response options.



8. Equipment.

All craft must be suitable for the activity, seaworthy, and capable of floating if capsized. All craft and equipment must meet regulatory standards, be properly sized, and be in good repair. Spares, repair materials, and emergency gear must be carried as appropriate.



9. Discipline.

All participants should know, understand, and respect the rules and procedures for safe boating activities provided by Safety Afloat guidelines. Applicable rules should be discussed prior to the outing and reviewed for all participants at the water's edge just before the activity begins.

Risk Management

Safe Swim Defense and Safety Afloat guidelines give the conscientious unit leader tools to prevent emergencies specific to aquatics activities. In effect, they are well-established risk management guidelines, which, if followed, should reassure the unit leader that the group is prepared for safe enjoyment of the aquatic world.

To some degree, the extent to which Safe Swim Defense and Safety Afloat guidelines manage risk depends on the willingness of each person in the group to take an active role. Scouting encourages youth to take responsibility for their behavior and safety. Ideally, each participant should feel concern and accountability for the safety of his or her buddy. A leader who empowers group members with resources, training, and responsibilities will often find that they can be trusted to do their own part to manage risks. If Scouts understand the rationale behind each point of Safety Afloat and Safe Swim Defense, they are more likely to comply.

An injury that doesn't happen needs no treatment. An emergency that doesn't occur requires no response.

—Chapter 11, “Emergency Preparedness,”
in the 2014 BSA *Fieldbook*.

However, the ultimate responsibility for risk management rests with the adult leader. Tigers can easily become caught in the excitement of a moment, completely forget the rules, and become oblivious to their surroundings, without being at all intentionally disrespectful or irresponsible. Teenagers are generally more aware of circumstances about them, but the teen brain is still in development and may not perceive risk the same as an adult mind. Part of risk management on any youth outing is understanding how to guide youth of a certain age toward desired behaviors. A list of rules will not instill that capability. However, the leader who has that skill can apply it to unfamiliar activities. As an aid, the chart at the end of Chapter 2 presents age-appropriate guidelines for aquatics activities.

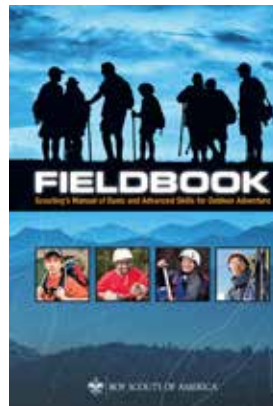

A leader's responsibilities seldom begin and end when a Scout enters and exits a swimming area. Swimming and boating are normally components of a unit outing, whether part of a den meeting or an extended wilderness trip by a Venturing crew. As an aquatics event moves farther from an emergency medical service (EMS) system and Scouts become dependent

on the food and gear they carry into the backcountry, the unit leader needs to consider risk management of situations that will not be covered in this text, such as shelter, food preparation, sanitation, and dangerous wildlife. Other training materials provided by the BSA should fill those gaps. The *Fieldbook* quoted at left is a good place to begin for outdoor adventure planning.

Although risks can be managed, they are seldom completely eliminated. Therefore, the prepared leader always has an emergency response plan and the skills and materials to implement it. Preparedness requires preparation. The next section will introduce generic components of emergency response plans, and other sections will provide details specific to swimming and boating.

However, the text may not cover some fundamental items, such as first aid skills, that apply to all unit activities whether in the water or on dry land. It is highly recommended that an adult is present at all unit gatherings who is trained in standard first aid and CPR.

In urban settings, unit leaders should know the approximate response time and how to contact emergency medical services. For backcountry trips, where communication is more difficult and response delayed, leaders may wish to consider courses in American Red Cross Wilderness First Aid and Wilderness First Responder.



Emergency Response Plans

In 1908, Baden-Powell, founder of the Scouting movement, offered the following observation on being prepared for an accident:

Be prepared to do that thing the moment the accident does occur. I will explain to you what ought to be done in the different kinds of accidents, and you must practice them as much as possible. But, the great thing for you Scouts to bear in mind is that wherever you are, and whatever you are doing, you should think to yourself: "What accident is likely to occur here?" and "What is my duty if it does?"

That statement is still excellent advice for anyone charged with supervising an activity. The first sentence means you have planned for emergencies. The second suggests you are trained in how to respond and that you keep your skills current through practice. The third means you are conscientious and continually on the alert. Perhaps you become a little on edge about how you and your group would respond to the scenarios you are running through your mind as conditions change and the activity progresses. If you aren't comfortable with the answers to the questions, you take immediate steps to reduce risk and improve preparedness.

Skilled planners "live" the experience in advance by thinking their way through every detail of an activity and likely emergency situation. Key skills, such as rescue techniques, are practiced. Equipment is tested; for example, you check that a cell phone has a signal. Drills are conducted to ensure that everyone in the unit understands their responsibility. Such preparation helps eliminate surprises. If an emergency occurs, uncertainty, confusion, and panic are replaced by self-confidence and prompt and appropriate action.

Emergencies confronting a unit leader during a unit swim or trip afloat may be either major or minor. Generally, minor emergencies are more likely but easier to deal with. Minor emergencies during aquatics activities include simple first aid cases, misuse of equipment, scuffles, approaching inclement weather, and capsize in calm, warm water. Major emergencies include cardiac arrest, spinal injury, drowning, and boaters pinned by current. Major emergencies, though rare, require additional planning. Keys to proper response are foresight, recognition, coordination, and practice.

Emergency action plans should exist for all BSA activities, not just aquatics. They are not always long and complicated, even for major emergencies. For a backyard swim, they may be very simple and require only a short discussion or review just before the activity. For a heart attack, a trained adult starts CPR while another dials 9-1-1. For a spinal injury, a trained adult provides in-line stabilization and waits in the water for paramedics to arrive. Emergency action plans for those or other life-threatening emergencies on a wilderness canoe trip will require more extensive planning and coordination. Plans should be reviewed with all the adults and senior youth leaders on the trip, and some items may need practice before the outing.

The first step in formulating an emergency action plan is to assess the various risks that should be covered. Some items, such as a small cut or a superficial burn, can be grouped together under a general first aid heading. Serious emergencies will generally share a common communication procedure and evacuation plan. Some situations, such as what to do if someone is caught in a hydraulic, may stand alone.

Each plan should address the following basics:

- When and how the plan is activated
- Who takes charge of the overall response
- Who conducts the rescue or provides aid to the victim
- What equipment will be needed, and where it is
- Communication between victim and rescuer
- Communication with and supervision of the rest of the unit members, who may assist with the effort or need to be removed from danger
- Who summons EMS, law enforcement, or other authorities, under what circumstances, and how
- After the victim is stabilized or removed from immediate danger, what follow-up care is needed, including (if necessary) how to evacuate the victim or the entire unit

Details will be provided in subsequent discussions of specific activities and locations. There is one additional item to be discussed here:

- Notification of parents and council office as appropriate

Whenever a person loses consciousness or needs medical care beyond simple first aid, such as transport by EMS to a hospital emergency room, leaders should

immediately notify the parent or other person designated in advance as an emergency contact. The emergency action plan should include such a contact list.

In case of a missing person, serious injury, or fatality, unit leaders are responsible for informing their council office as soon as possible. The Scout executive or designee will provide trained help with notification of next of kin, dealing with the press, and counseling for others in the unit.

Youth Protection

The Boy Scouts of America places the greatest importance on creating the most secure environment possible for our youth members. To maintain such an environment, the BSA developed numerous procedural and leadership selection policies and provides parents and leaders with resources for the Cub Scout, Boy Scout, and Venturing programs.

The BSA takes great pride in the quality of our adult leadership. Being a leader in the BSA is a privilege, not a right. We work closely with our chartered organizations to help recruit the best possible leaders for their units.

The BSA has implemented mandatory Youth Protection training for all registered volunteers. New leaders are required to complete Youth Protection training within 30 days of registering.

The adult application requests background information that should be checked by the unit committee or the chartered organization before accepting an applicant for unit leadership.

Please visit www.scouting.org/YouthProtection for Scouting's Barriers to Abuse and other important resources.

Two registered adult leaders or one registered leader and a parent of a participant, or other adult, one of whom must be 21 years of age or older, are required on all trips and outings. All registered adults must have completed Youth Protection training.

Therefore, even though Safe Swim Defense or other aquatics policies may designate that only one trained adult is needed to supervise the activity, it is assumed that at least one other responsible adult, who may not be trained in water safety, is available to assist with implementing an emergency action plan.

The Youth Protection policies of the BSA also address privacy and appropriate attire. Adult leaders must protect their own privacy and respect the privacy of youth members in situations such as changing into swimsuits, whether in a changing room at a public water park or at a remote campsite. Neither skinny-dipping nor revealing bathing suits are appropriate as part of Scouting.

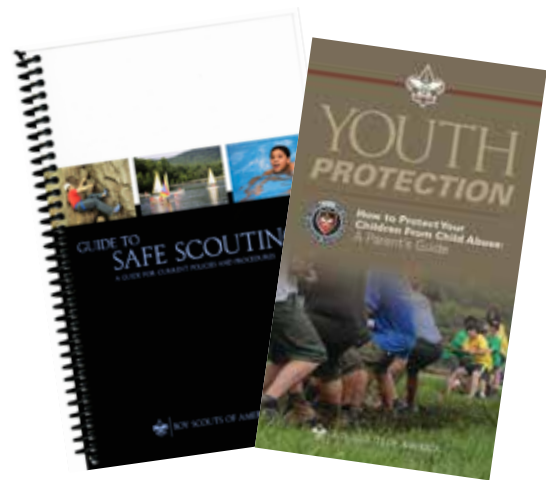

Additional information on Youth Protection and transportation is found in these publications.

Transportation

Since traffic accidents are the primary cause of accidental death in the United States, with the number of fatalities far exceeding those from drowning, unit members may be more at risk traveling to an aquatics area than when engaged in the activity. The BSA has established transportation policies and guidelines to minimize such risk. The complete policies are in the *Guide to Safe Scouting* and should be reviewed before the unit goes on an outing. By way of review, recall that:

- Transport by commercial carriers, such as chartered buses, is recommended, particularly for large groups.
- Except in special circumstances, all drivers must be at least 18 years of age with a valid license for the type of vehicle in use, and must observe traffic regulations, including speed limits.
- All occupants of cars, vans, and trucks must wear seat belts.
- Driving time is limited to a maximum of 10 hours per day and must be interrupted by frequent rest, food, and recreation stops.

- Fatigue is a major cause of highway accidents. Don't drive while drowsy.
- All driving, except for short trips, should be done in daylight.

Highway transport of boats, by trailer or on roof carriers, requires special consideration and will be discussed further in sections on various craft.

Tour and Activity Plans

There is no national policy that requires units to file a formal tour plan with local councils. However, informed planning at the unit level is a practical concept that fosters successful, safe activities and is recognized as such in the BSA Safety Afloat policy.

Legal Considerations

A leader's moral obligation to protect the youth under his or her supervision should overshadow any concerns about legal accountability. Nevertheless, some volunteers may have concerns about legal exposure should something happen despite their diligent efforts. The best way to avoid litigation is to prevent physical or mental trauma through safety awareness, preparation, consistent application of policies, and other tools of risk management. The material reviewed here is presented as an additional aid to ensure preparedness, not as a reason to forego the pleasure, challenges, and satisfaction that arise from participating in aquatics activities.

Most legal actions that result from an accident during a supervised youth activity are civil: an injured party, or **plaintiff**, charges a person or organization, the **defendant**, with responsibility for the accident. Legal responsibility, or **liability**, is the issue, and the court may award compensation for both actual damages and as punishment (a punitive award). In a criminal case, the government charges the defendant with violating a law. The issue is guilt, which if proved, causes the court to impose punishment.

Although civil suits may be initiated under a wide variety of circumstances, the plaintiff generally must establish that harm has resulted from **negligence**, or the failure to act properly. Negligence need not be intentional or willful. It arises when the defendant fails to act appropriately, or acts improperly. Negligence can result from carelessness, poor judgment, forgetfulness, inexperience, ignorance, or failure to notice and/or correct a hazardous situation.

To establish negligence, the plaintiff must first show that the defendant had a **duty to act**. A duty to act, or duty of care, is established when a person or organization accepts responsibility for the safety of another. A parent has a duty to a child. **In loco parentis** means that another person has temporarily assumed a parent's responsibility. A person who invites a neighbor's child to play in a backyard wading pool has a duty of care, as does a Scoutmaster supervising a troop swim on a campout.

After a court determines that a duty of care exists, the next step is to determine the **standard of care** that applies to that duty. The parent watching neighborhood children in a wading pool may only be required to act as a "reasonable" or "prudent" person would under the circumstances. A bystander applying first aid at an accident scene is generally held to a lesser standard of care than an on-duty emergency room physician. Lay persons are often afforded some legal protection by Good Samaritan laws, so long as they act in accord with and within the limits of any training they have received. Note that the standard of care expected of a volunteer leader may be modified by the training and policies imposed by a sponsoring organization. For example, a plaintiff may establish negligence by showing that the actions of a Scout leader were not in accord with BSA policy or that they were inconsistent with how similarly trained persons would have acted.

Failure to perform the duty of care to the appropriate standard is called a **breach**. A breach by itself does not constitute negligence. Harm or damage has to result from the breach.

The following examples, some of which may fit in more than one category, may support a claim of negligence. Numerous other examples can be constructed simply by taking the inverse of any previously stated safety policy.

Failure to provide a safe environment:

- No boundary line is used between deep water and the nonswimmer area.
- Youth are provided with adult-sized life jackets.
- A tripping hazard exists where sections of a floating dock are attached.

Improper action:

- The unit leader leaves swimmers unattended.
- A youth is pressured to attempt a skill he is uncomfortable doing.
- Dangerous actions are encouraged, such as racing starts in shallow water or running a low-head dam.

Lack of action:

- First aid is not provided, or is stopped too soon.
- Rapids are not scouted.
- Rules are not enforced, or are enforced inconsistently.

According to **respondent superior doctrine**, an organization or employer can be held responsible for the negligence of a volunteer or employee. The Scoutmaster, the local council, and the National Council may all be named in a suit that originates from the actions of an assistant leader. While the attorneys representing the plaintiff may prefer to go after the “deep pockets” that can afford both the legal fees and the care due an injured party, lack of personal wealth does not protect any defendant from the wrath of an aggrieved parent and the indignation of a jury. Future earnings may be garnished in civil actions. To help protect the financial resources of volunteers and employees, BSA local councils provide liability insurance through the National Council.

A unit leader faced with recruiting additional volunteers may find it useful to review BSA insurance programs. The BSA self-funds the first million dollars of each liability claim. Accident and sickness insurance pays regardless of fault as long as the accident occurred during an official Scouting activity and the unit or council has purchased the coverage.

Many BSA volunteers also assist other organizations, such as schools, churches, and sports leagues. The prudent volunteer should realize that not all nonprofit organizations provide volunteers support at levels similar to the BSA. Many such groups offer liability insurance coverage only to volunteers on the boards of directors.

National Camp Standards



Volunteers at the district and council level should be aware that state regulations may impose increased standards of care on multi-unit activities. Also, the BSA has additional standards beyond those in the *Guide to Safe Scouting* that govern day camp and resident camp activities. In

particular, the BSA requires that a camp aquatics director must have training from a National Camping School. BSA camp standards and state regulations require certain numbers of the aquatics staff to have professional-level lifeguard training, such as BSA Lifeguard or Red Cross lifeguard training. Training in Safe Swim Defense or Aquatics Supervision: Swimming and Water Rescue is not adequate.





Health Considerations

Reviewing Medical Histories

Both Safe Swim Defense for swimming and Safety Afloat for boating require the unit leader to assess whether there are any health conditions that require special consideration:

A complete health history is required of all participants as evidence of fitness for swimming and boating activities. Forms for minors must be signed by a parent or legal guardian. Participants should be asked to relate any recent incidents of illness or injury just prior to the activity. Supervision and protection should be adjusted to anticipate any potential risks associated with individual health conditions. For significant health conditions, the adult supervisor should require an examination by a physician and consult the parent, guardian, or caregiver for appropriate precautions.

The BSA has established minimum standards for providing medical information before participation in various activities. The type of information required depends on the duration, location, and rigor of the event. Printed forms are available from council service centers or at www.scouting.org.

Policy on Use of the Annual Health and Medical Record

The Annual Health and Medical Record consists of four parts. **Part A** is a health history. **Part B** covers informed consent, hold harmless/release agreement, talent release, and the person whom parents or guardians authorize to take youth to and from events. Parts A and B are to be completed at least annually by participants in all Scouting events.

Part C is a physical exam to be completed and signed by a certified and licensed health-care provider—physician (MD or DO), nurse practitioner, or physician assistant. The BSA recommends that everyone who participates in a Scouting event have an annual medical evaluation. However, Part C is only required for events that exceed 72 consecutive hours, for high-adventure base programs, or for activities that are strenuous and demanding.

The height/weight limits in Part C must be strictly adhered to when the event will take the unit more than 30 minutes away from an emergency vehicle-accessible roadway.

Part D is to be reviewed by all participants of a high-adventure program at one of the national high-adventure bases and shared with the examining health-care provider before completing Part C.

Part D includes a Recreational Scuba Training Council medical statement and guidelines for the recreational scuba diver physical examination that applies to participants in scuba programs at the Florida National High Adventure Sea Base. Scouts working on the Open Water Diver Certification requirement for the Scuba Diving merit badge will be subject to a similar medical review process by the agency conducting their training.

The Annual Health and Medical Record must be signed by the parent or guardian of a minor or the adult to whom they apply.

The unit leader should carry copies on remote trips so that important information, such as drug allergies and contact numbers, will be readily available if professional treatment is needed.

The adult supervisor should review the health history of every participant, youth and adult, for swimming or boating activities and respect any recommendations of the physician or other person licensed by the state to perform

physical examinations. Some medications increase sensitivity to the sun. Individuals with severe allergic reactions to insects and marine life will need immediate access to self-administered medication. Certain chronic conditions such as epilepsy, asthma, or diabetes may require special precautions. For example, a person with seizures controlled by medication may be able to participate in normal swimming activities in a pool when accompanied by a buddy familiar with the situation, but be required to wear a flotation device when engaged in an open-water snorkeling exercise. The unit leader should discuss such situations with parents or guardians and respect the privacy and the dignity of the person involved. Medical information should be requested only when safety is an issue, and shared only with permission with those who need to know.

HIPAA

The Health Insurance Portability and Accountability Act of 1996 does not apply to Scouting volunteers who do not receive payment for medical treatment. However, all units should take reasonable steps to maintain confidentiality of medical histories, birth dates, and other personal information.

The most common medical conditions that require restricted water contact are temporary and may not be noted on a health history completed before the condition arose. Those include ear infections, healing wounds, eye irritations, and rashes. Since such conditions are not always visible, the adult supervisor should ask parents about any recent medical problems just before the outing. Such a question can be combined with standard permission slips that inform parents of the nature of the activity and allow emergency medical treatment for a youth in case of injury or illness when a guardian cannot be contacted.

Aquatics activities often offer unique opportunities for those with physical or learning disabilities. Any youth who is able to join in unit activities on land can probably also join in unit swimming and boating activities. Special precautions may be needed for those with impaired mobility, sight, or hearing. Check with the participant and his or her caregivers on appropriate safeguards and activities.

Health Protection

The supervisor of an aquatics activity needs to be alert for health concerns that may develop during the session.

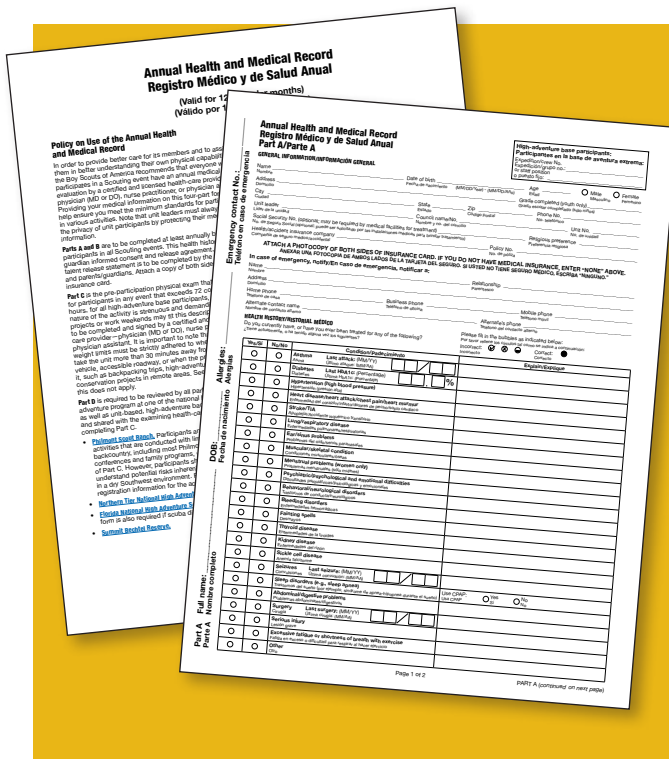

Check medical forms for any conditions that necessitate special precautions. If in doubt, check with parents.



Don't forget to check for recent conditions not noted on your forms.



Work with unit members, parents, and caregivers to provide safe and fun aquatics activities for everyone in the unit.



Some conditions may require prompt treatment with medications. Arrange for easy access for those in the water. Know how to assist the person if needed.

Sun Protection. Youth may regard a minor sunburn as a badge proclaiming their outdoor adventure and the first step to a summer tan. However, exposure to the sun should be carefully monitored. Only a short period in the sun can lead to a painful burn that will spoil the rest of the trip. Also, skin damage caused by the sun during the first 18 years of life is a major cause of skin cancer as an adult. Insist that participants use sunscreen as appropriate. Pink skin that turns pale with touch is a sign of too much exposure and a signal to either cover the skin with opaque clothing or limit activities to the shade.

Sunscreen with an SPF rating of at least 15 should be applied before exposure and reapplied after sweating or swimming even if the product claims to be waterproof. Although sunscreen will block part of the ultraviolet light that causes damage, and prolong the safe exposure time, applying more does not extend the period of protection, which is still limited no matter how high the SPF number. A white T-shirt will provide reasonable but not complete protection, particularly if the shirt is wet.

Bright sunlight can also damage the eyes. A hat with a bill that shades the eyes is useful, and sunglasses with UV protection help protect against glare off the water. Polarized glasses are recommended because reduction of glare offers eye protection and makes it easier to observe activity on or beneath the surface.

Heat Reactions. Exercise in high temperatures and humidity can lead to dehydration, heat exhaustion, and heatstroke. Avoid such consequences by making sure that all participants have ready access to drinking water. Drinking when thirsty should prevent dehydration. Eating regular meals will help prevent electrolyte imbalance that may lead to cramps. Anyone feeling dizzy, faint, nauseated, or weak should rest in the shade.

Cold Reactions. Too little heat is as dangerous as too much heat. Even when the air is warm, exposure to cool or cold water can quickly remove heat from the body. Watch all participants for early signs of heat loss such as shivering, goose bumps, and bluish lips. When those occur, get the person out of the water and wind and into dry clothing. When exposure to cold water is a possibility, consider the use of wet suits, and include treatment for hypothermia in your emergency action plan. See Chapter 14 for more information.



Waiting until a sunburn appears means you have waited too long to protect your skin.



Sun exposure while young can lead to life-threatening conditions when older. Check with a physician about suspicious skin features.

Hyperventilation. Breathing is triggered by a buildup of carbon dioxide rather than depletion of oxygen. Repeated deep and rapid breathing, or hyperventilation, before underwater swimming can result in loss of consciousness by delaying the urge to breathe. Breath-holding is an important stage in learning to swim, and the ability to swim underwater is an important skill for snorkeling and lifesaving. However, one or two deliberate breaths should be sufficient. Caution anyone obviously breathing heavier than normal before submerging. Because of concerns with hyperventilation, competitive underwater swimming events are not permitted in Scouting.



Because of the danger of overbreathing, breath-holding contests are prohibited.

Ear Infections. Organisms in natural bodies of water can multiply when water remains in the ear canal after swimming, causing irritation and infection. Over-the-counter eardrops contain ingredients that inhibit organism growth (mild acid), help remove the water (alcohol), and prevent over-drying (glycerin). Scouts may use such preparations as a preventive measure with parental approval. Avoid homemade solutions. Don't place anything in the ear if pain is present; instead, seek medical help.

Infectious Disease. Illness may be spread via contaminated water, particularly water polluted with fecal matter. Avoid swallowing water while swimming, in either a pool or a lake. Don't swim in small stagnant bodies of water or where livestock or waterfowl are prevalent. Observe any warning signs posted by health officials. Popular beaches may be temporarily closed due to unexpected sewage release, low water, or other factors.

Water in swimming pools is actively disinfected. However, typical pool chlorine levels do not immediately kill all pathogens in water contaminated with fecal matter. If fecal matter is released in a pool—from a toddler with diarrhea, for example—cancel the swimming activity until another time.



The Greatest Risk:

In good years, no one drowns at Scouting events. In tragic years, drowning incidents may be counted on the fingers of one hand. However, year after year, two or more hands are needed to count the number of adults who die during Scouting activities. The number one cause of death in Scouting and for the public at large is heart disease. Statistically, unit leaders are less likely to need to rescue a youth from drowning than they are to need aid themselves to survive cardiac arrest in the water.

In response, the BSA has implemented various initiatives such as annual physicals, activity restrictions based on height/weight ratios, and CPR/AED training. Leader fitness is also a common program theme. All adults should review the risk factors for heart disease and do what they can to mitigate those risks, particularly through exercise and a heart-healthy diet.

Although the first obvious symptom of a problem often appears to be a fatal heart attack, nearly all patients have warning signs such as chest pains and breathlessness immediately before the attack.

During Scouting events, adult leaders need to watch out for each other as well as the youth under their care.





Swim Classification Tests

Safe Swim Defense and Safety Afloat guidelines tailor activities to swimming ability. Therefore, the unit leader needs to provide opportunities for swim classification before aquatics outings. Swim tests conducted by council personnel during or just before summer camp give the unit one way to determine swimming ability. However, not all unit members attend camp, new members may join the unit at any time, and some units plan aquatics activities in lieu of summer camp. Therefore, the unit should be able to safely conduct its own swim tests.

Swimmer Classifications

Scouting recognizes three basic swimming classifications: **swimmer**, **beginner**, and **nonswimmer**. Swim classification tests should be renewed annually, preferably at the beginning of the season.

The **swimmer** test demonstrates the minimum level of swimming ability required for safe deepwater swimming. The various components of the test evaluate several distinct, essential skills necessary for safety in the water. A precise statement of the swimmer test is:

Jump feetfirst into water over the head in depth. Level off and swim 75 yards in a strong manner using one or more of the following strokes: sidestroke, breaststroke, trudgen, or crawl; then swim 25 yards using an easy, resting backstroke. The 100 yards must be completed in one swim without stops and must include at least one sharp turn. After completing the swim, rest by floating.

The test administrator must objectively evaluate both the ease of the overall performance and the purpose of each test element. Any conscientious adult who is familiar with basic swimming strokes and who understands and abides by the following guidelines can administer the test.

1. “Jump feetfirst into water over the head in depth. Level off . . .”



The swimmer must be able to make an abrupt entry into deep water and begin swimming without any aids. Walking in from shallow water, easing in from the edge or down a ladder, pushing off from the side or bottom, and gaining forward

momentum by diving do not satisfy this requirement. If the swimming area available for the test is not quite over the swimmer’s head in depth, or does not provide a platform for jumping into deep water, then a person may be provisionally classified as a swimmer if able to easily bob repeatedly up and down in the water, then level off and begin swimming. The head must submerge without the legs touching bottom. Ideally, the feetfirst entry should be tested at the next available opportunity.

2. “. . . swim 75 yards in a strong manner . . .”



The swimmer must be able to cover distance with a strong, confident stroke. The 75 yards is not the expected upper limit of the swimmer’s ability. The distance should be covered in a manner that indicates sufficient skill and stamina for the swimmer to continue to swim for greater distances. Strokes repeatedly interrupted and restarted are not sufficient. The sidestroke, breaststroke, or any strong over-arm stroke, including the back crawl, are allowed in any combination; dog paddling and underwater strokes are not acceptable. The strokes need to be executed in a strong manner, but perfect form is not necessary. If it is apparent that the swimmer is being worn out by a poorly executed, head-up crawl, it is appropriate for the test administrator to suggest a change to a more restful stroke. A skilled, confident swimmer should be able to complete the distance with energy to spare, even if not in top physical condition. There should be little concern if a swimmer is out of breath because the distance was intentionally covered at a fast pace. However, a swimmer who barely has the energy to complete the distance will benefit from additional skill instruction.

3. “. . . swim 25 yards using an easy, resting backstroke.”



The swimmer must demonstrate a restful, free-breathing backstroke that can be used to avoid exhaustion during swimming activity. It is placed at the end of the distance requirement to

emphasize the use of the backstroke as a relief from exertion and may actually be used by some swimmers to catch their breath if they swam the first part more strenuously than needed. The change of stroke must be done without support from side or bottom. Any effective variation of the elementary backstroke is acceptable. The form need not be perfect. For example, a modified scissors kick may be substituted for a whip kick. Restful strokes are emphasized in Scouting as important safety skills that can be used whenever the swimmer becomes exhausted or injured. Some swimmers, particularly current or former members of competitive swim teams, may not be familiar with the elementary backstroke. A back crawl will suffice for the test if it clearly provides opportunity for the swimmer to rest and catch the breath. However, individuals successfully completing the test with

the back crawl should be encouraged to learn the elementary backstroke.

4. “The 100 yards must be completed in one swim without stops and must include at least one sharp turn.”



The total distance is to be covered without rest stops. It is acceptable for someone to float momentarily to work out a kink in a muscle or to tread water to avoid collision with another swimmer, but not to make up for a poorly executed stroke by repeatedly floating, grasping the side, or touching the bottom. The sharp turn demonstrates the important skill of reversing direction in deep water without support. There is no time limit for completion of the test.

5. “After completing the swim, rest by floating.”



This critically important component evaluates the swimmers’ ability to support themselves indefinitely in warm water when exhausted or otherwise unable to continue swimming. Treading water will tire the swimmer and is therefore unacceptable. The duration of the float is not significant, except that it should be long enough for the administrator to determine that the swimmer is in fact resting and could continue to do so. A back float with the face out of the water is preferred, but restful facedown floating is acceptable. If the test is completed except for the floating requirement, the swimmer may be retested on the floating only (after instruction), provided the test administrator is confident that the swimmer can initiate the float in deep water when exhausted.

A precise statement of the **beginner** test is:

Jump feetfirst into water over the head in depth, level off, and swim 25 feet on the surface. Stop, turn sharply, resume swimming and return to the starting place.

The entry and turn serve the same purpose as in the swimmer test. The swimming may be done with any surface stroke. Underwater swimming is not allowed. The stop assures that the swimmer can regain the stroke if it is interrupted. The test demonstrates that the beginner

swimmer is ready to learn deepwater skills and has the minimum ability required for safe swimming in a confined area in which shallow water, sides, or other support is less than 25 feet from any point on the water.

Anyone who has not completed either the beginner or the swimmer test is classified as a **nonswimmer**. The title is descriptive and nonjudgmental. It may represent those just learning to swim who do not yet have the skills to safely venture beyond shallow water. It may also apply to those who have not yet been tested or who have elected to forego the test and to accept the limitations on activities imposed by the classification.

Both nonswimmer and beginner classifications prevent a Scout from gaining the full benefit of aquatics programming. Unit leaders should promote swimming ability to all members and strive to have everyone in the unit classified as swimmers. Such a goal increases each Scout’s safety and confidence, provides more recreational and instructional opportunities, and makes it easy for units to administer their own aquatics programs. Note that the beginner test is a requirement for Boy Scout Second Class rank, whereas the swimmer test is a requirement for First Class rank. A troop’s ability to conduct swim classification tests also makes it easier to administer rank advancement.

Testing Procedure

All swimming activities, including swim classification tests, follow the elements of Safe Swim Defense. The health history of each individual should be reviewed before testing. No one should be allowed in the water against the recommendations of parents, guardian, or physician. Those who are not allowed to enter the water for whatever reason do not automatically fall into the nonswimmer category. Normally, nonswimmers are encouraged to participate in aquatics activities as an incentive to improve their skills. If the aquatics activities are conducted by the unit, then the adult in charge of the event should know the difference between those classified as nonswimmers on the basis of skill, and those not allowed to swim due to a chronic or temporary physical condition that limits water contact. The unit may be asked to conduct swim classification tests before participation in a multiple-unit event, such as summer camp or jamboree. In those cases, care should be taken to preclude participation in an event as a nonswimmer by someone who should not be in the water. The unit leader should discreetly communicate such situations to the event supervisor. The youth should be privately put on his honor not to circumvent any restrictions.

Situations may arise when special consideration should be given to those with temporary medical conditions. For example, yearly swim classification renewals may be scheduled just before a canoe trip. A physician may approve a person with an ear infection or a sutured wound to go on the trip, but caution against submerging the head or the bandage. Since it would be difficult to administer the swim test without getting the ears or the wound wet, the adult leader might classify the Scout temporarily as a nonswimmer. That, however, would prevent the Scout from paddling in a canoe with their buddy. If the unit leader has sufficient evidence that the Scout is indeed a good swimmer—one who has earned the Lifesaving merit badge, for example, or is a member of a swim team—then an extension of the Scout’s previous swimmer classification is appropriate until he heals sufficiently to retake the test.

The ideal place to conduct a swim test is a swimming pool with straight stretches of 25 to 50 yards and clear water at least 7 feet deep at the point of entry. Those taking the swimmer test can then be instructed simply to swim either four or two lengths as appropriate. A pool 25 or 50 meters in length is easily adapted by placing a turning mark or line at the yard mark, or by having the person swim the short extra distance. (Recall that the swimmer test is not meant to demonstrate the maximum distance a person can swim.) The course may also be laid out such that the swimmer follows a circular pattern around the pool rather than back and forth, but be sure to incorporate the sharp turn required by both beginner and swimmer tests.

Very small backyard or apartment pools (less than roughly 20 feet in the maximum direction) are fine for a unit swim, but should be avoided as locations for swim classification tests since likely contact with the sides and bottom during all the turns makes it difficult to judge how well the person can swim. Such pools may also be too shallow to meet the criterion for a feetfirst entry into water over the head in depth.

Any natural body of water that satisfies Safe Swim Defense requirements may be used for swim classification tests. Clear water is preferred over murky water; warm water over cold water. A pier that extends from shore to deep water is ideal for the feetfirst entry in the requirements, but a floating platform can also be used.

If a pool open to the public is used for testing, try to schedule a time when the pool is less crowded. Inform pool personnel

Beginners:

- ✓ Jump into deep water.
- ✓ Swim 25 feet.
- ✓ Turn.
- ✓ Return.
- ✓ Total: **50 feet** with entry and turn

Swimmers:

- ✓ Jump into deep water.
- ✓ Swim 75 yards with strong forward stroke.
- ✓ Swim 25 yards with restful backstroke.
- ✓ Rest by floating.
- ✓ Total: **100 yards** with entry and turn



Swim tests are done one-on-one, with the examiner and youth as buddies.



Participant is asked to describe test and confirm comfort with each task. If there is any hesitation, check ability first in shallow water.

of what you are doing. A guard may be willing to clear an area briefly if you have only one or two Scouts who need the test.

During swim classification tests, the swimmer and the test administrator form a buddy pair. If there is a large group needing tests, then several testers are useful. Individual testing is required. Unit members should not be aligned at each lane and started at once, as in a swim competition.

Although the tests may be explained to the unit as a whole, the test administrators should briefly review the tests with each participant. Each person should be asked if he or she would like to first try the beginner or the swimmer test. If the person asserts the ability to easily swim 100 yards, then it is not necessary to take the beginner test before the swimmer test. If a person is hesitant, they may take the beginner test first and follow it with the swimmer test if that seems appropriate. Those who



Tests measure comfort in the water but do not require perfect form.



Rest stops are not allowed. However, the course should be close to the side to allow for resting and easy assists if needed.

fall just short of the required distances may be given a few pointers, a rest, and another try. Those who cannot complete the tests should be congratulated on how far they got, encouraged to practice, and told that they will be able to retake the test at a later date. If a person in a swimsuit at the swimming area decides not to take either test, then they should be encouraged to slip into shallow water and show what they do know. That is, professed nonswimmers should be part of the overall unit activity, not shunted aside in the interest of time. Everyone should be encouraged to try to swim to the best of their ability, but no one should be coerced into the water.

Some participants may be willing to jump into water over their head even though they have never done it. Therefore, every participant should be asked if they have jumped into deep water before. If they have not, first confirm that they can swim in shallow water and then see if they are comfortable in deep water with a slide-in entry at the edge. The test may proceed once the person demonstrates comfort in deep water.

With proper screening, those taking the test should not be at risk of a bad experience. Nevertheless, test administrators should be ready and able to provide immediate assistance if the swimmer does need help, perhaps due to a cramp or exhaustion. Ideally, the course for the beginner test should be alongside a pool deck or pier so that the swimmer is always within a hand's reach or a single stroke from support. The course for the swimmer test should be within reach of a pole. The best way to keep poles ready for use is to lay them along the edge of the pool or pier. A pole is then within easy, unobtrusive access at all times. If the course incorporates a floating dock in a natural body of water, then the feetfirst entry and first few strokes should be within easy reach. If the course then extends beyond the reach of a pole, the swimmers should be either within reach of rescue personnel in a rowboat or canoe or within easy throwing distance of a ring buoy on a line or a throw bag. If a person taking the test succeeds in leveling off after the feetfirst jump, then the most likely need will be to encourage a tired swimmer to come to the side under their own power. In a few cases, a reaching assist may be needed immediately after the feetfirst entry. Test administrators should be skilled in basic rescue techniques to satisfy Safe Swim Defense guidelines for trained safety personnel. If there are others in the water not taking part in the testing, then additional response personnel (lifeguards) are needed. In either case, a lookout is required to monitor all in-water activity.

Swim Test Anxiety

Both the unit leader and the test administrator should be sensitive to those who may be fearful of the water, uncertain of their ability, worried about peer reaction, otherwise apprehensive, or simply confused about the process and what is expected of them. The unit leader should work with the test administrator to help prepare such Scouts for the swim test, particularly when it is conducted by someone the Scout is unfamiliar with, such as staff at resident camp or at a multiunit, council-organized swim test prior to camp.

The first day of a camp program may be an overwhelming experience for Scouts for many reasons—being away from home and the support systems that home provides, the thrill but uncertainty of what they will experience at camp, and perhaps thoughts of how they will measure up in comparison to their buddies. At summer camps, the swim test is often the first program activity where Scouts both interact significantly with those outside the unit and are asked to perform to a standard. That experience may produce significant anxiety for a small number of youth. However, there is no justification for fears to be realized. The unit leader can help prepare those Scouts both before and at camp so that the swim test is a positive experience. The following items should help leaders recognize and reduce anxiety about the testing process:

- **Early identification.** Scouts who may be anxious around the water or with the swim test process should be identified well before summer camp or other event for which the test is required. Comfort around the water should be included in the leader's discussion with parents for youth who join the unit. The leader should also talk to the youth themselves. For Cub Scouts, check to see if swimming is an interest. For Boy Scouts, comfort in the water should arise naturally during discussions of advancement requirements for Second Class, which includes the beginner test, and for First Class, which includes the swimmer test. Be sure to watch for non-verbal cues to see if their body language matches what they say.
- **Year-round swimming programs.** A year-round swimming program provides meaningful and fun activities and allows the leader to observe firsthand the comfort level of Scouts around the water. It also provides an opportunity to see how unit members respond to those reluctant around the water or with lesser swimming ability. For troops, it will help move Boy Scout

advancement along faster. Ideally, the first time the Scout takes a swim test is during a learn-to-swim class with a familiar, trusted instructor conducting the exercise. Subsequent tests are just repeats of tasks the swimmer knows they have accomplished before.

- **Consider precamp swim tests.** Some councils arrange precamp swim tests for units. If that option is available, consider whether youth with swim test anxiety might perform better away from the other first-day camp activities. If allowed, reluctant members of the unit might arrive early to get adjusted to the water and take a "mock" test prior to the "real" test. (Note that the camp aquatics director may retest any Scout or leader whose skills appear inconsistent with their classification.)
- **Prepare the unit for the test.** The leader should familiarize Scouts with the swim test process as part of the unit's camp readiness discussions. Explain the purpose of the test and how it will be conducted. Explain that each youth's swimming ability may be different and that the better swimmers are expected to encourage and support those with lesser ability. Remind everyone that opportunities to retake the test will be provided to those who don't make it as far as they would have liked. Encourage any youth who needs to speak with the leader in private to do so. And remember that no one should be forced—whether by anyone's statement or through peer pressure—to take either test if they choose not to.
- **Work with the camp aquatics director.** The camp aquatics director should approach the unit leader when the unit arrives at the swimming area for orientation before the test. That is an intentional opportunity for the leader to identify any medical concerns and to discuss any youth who may be anxious about the swim test. Make sure the aquatics director assigns an empathetic, experienced staff member to work with each such youth and stay with the youth until the staff member establishes a reasonable rapport. The tests will be conducted one-on-one, so it should be possible for leaders to stagger interactions with more than one Scout. If the Scout remains anxious, the leader may request the aquatics director to arrange a special time to conduct the test for that individual when there is less activity in the area and more time for the youth to become comfortable before taking the test.

Review Questions for Section I

- 1.1 Unit leaders accompanying Scouts on an outing are absolved of all responsibility when a professionally trained individual leads an activity.**
T F
- 1.2 Unit leaders need not be skilled in an activity that is being conducted by a professionally trained individual.**
T F
- 1.3 Unit leaders conducting an activity must be skilled in the activity and able to respond appropriately in an emergency.**
T F
- 2.1 Cub Scouts earn awards by**
A. Doing their best
B. Meeting performance standards
C. Winning competitions
D. Attending required classes
- 2.2 Boy Scouts earn awards by**
A. Doing their best
B. Meeting performance standards
C. Winning competitions
D. Attending required classes
- 2.3 Which of the following must a youth accomplish to advance to Eagle Scout rank?**
A. BSA swimmer classification
B. Swimming merit badge
C. Lifesaving merit badge
D. All of the above
- 3.1 Which of the following is not an allowed activity for Cub Scouts?**
A. Learn-to-swim programs
B. Snorkeling in confined area
C. Riding in a motorboat
D. Tubing on gently flowing water
- 3.2 Which of the following is not an allowed activity for Boy Scouts?**
A. Snorkeling in open water
B. Cliff diving into deep, clear water
C. Canoe trips on moving water
D. Driving a motorboat
- 3.3 Which of the following is not an allowed Venturing activity?**
A. Scuba diving in open water
B. Triathlon events
C. Commercial trips on white water
D. Parasailing
- 4.1 Drowning is a statistically significant cause of accidental death for 1- to 4-year-olds.**
T F
- 4.2 Drowning follows car accidents as the second leading cause of accidental death for Scout-aged youth.**
T F
- 4.3 Because many people swim at public pools, most drownings occur at supervised pools even with lifeguards on duty.**
T F
- 5.0 List three contributory factors to drowning.**
1.
2.
3.
- 6.1 Ultimate responsibility for safety rests with the unit member, not the unit leader.**
T F
- 6.2 If adequate preventive steps are in place, an activity can safely proceed without emergency response plans.**
T F

- 6.3 Risks can be managed but seldom completely eliminated.**
T F
- 7.0 List three items common to all emergency action plans.**
1.
2.
3.
- 8.0 BSA policies allow a single adult to supervise a den on a remote hike to a swimming beach provided Boy Scouts are available to serve as lifeguards.**
T F
- 9.1 A tour and activity plan must be submitted for council review for all unit swimming activities.**
T F
- 9.2 A tour and activity plan is not needed for a swimming activity at a parent's backyard pool.**
T F
- 10.1 A ruling of negligence must establish that harm resulted.**
T F
- 10.2 A ruling of negligence must establish the intent to harm.**
T F
- 10.3 Good Samaritan laws completely protect a unit leader from charges of negligence.**
T F
- 11.1 All swimming and boating activities require a current health history for every participant.**
T F
- 11.2 Adults require a medical evaluation within the previous 12 months for all activities.**
T F
- 11.3 Adults require a medical evaluation within the previous 12 months for any event exceeding 72 hours.**
T F
- 12.1 Which is the more common medical condition that will limit access to the water?**
A. Cardiovascular disease
B. Use of medication to control seizures
C. Ear infection
D. Allergy to jellyfish venom
- 12.2 Which of the following mandates exclusion from the water?**
A. Cystic fibrosis
B. Use of medication to control seizures
C. A parent's or physician's instruction on the medical form
D. All of the above
- 12.3 Which of the following may require additional safety measures while swimming?**
A. Cystic fibrosis
B. Use of medication to control seizures
C. Deafness
D. All of the above
- 13.1 Special precautions for those with chronic or temporary medical conditions are based on**
A. Consultation with the parents
B. A physician's written recommendations
C. Instructions from a caregiver accompanying the individual
D. All of the above
- 13.2 Competitive breath-holding events are not allowed due to concerns with**
A. Hyperventilation
B. Hyperthermia
C. Hypothermia
D. Ear infections
- 13.3 Which of the following is not a symptom of the early stages of hypothermia?**
A. Shivering
B. Goose bumps
C. Pink skin
D. Bluish lips

- 14.1** Frequent, minor sunburn is a long-term as well as a temporary concern.
T F
- 14.2** Frequent application of suntan lotion with an SPF larger than 30 extends safe time in the sun indefinitely.
T F
- 14.3** Fecal incidents in a well-maintained pool are not a cause for concern.
T F
- 15.0** During Scouting events, statistically the most prevalent cause of death is
A. Car accidents
B. Drowning
C. Cardiac arrest
D. Falls
- 16.0** List the components of the BSA beginner classification test.
- 17.0** List the components of the BSA swimmer classification test.
- 18.1** Anyone who declines to take or fails to complete the BSA beginner classification test is classified as a learner.
T F
- 18.2** The BSA beginner classification test is a requirement for Second Class rank.
T F
- 18.3** The BSA swimmer classification test is a requirement for Second Class rank.
T F
- 19.1.** A person must first complete the beginner test before taking the swimmer test.
T F
- 19.2** Anyone reluctant to take either the beginner or swimmer classification test is not allowed in the water during the testing procedure.
T F
- 19.3** A single test administrator may watch up to four participants taking the swimmer test simultaneously.
T F
- 20.1** A person is not given nonswimmer privileges if
A. The person is unwilling to attempt the beginner test.
B. The person has no desire to enter deep water, even though he/she can swim well.
C. The person has a physical condition that prohibits any water contact.
D. All of the above
- 20.2** Prior to water entry, how does the test administrator determine whether the participant has been in deep water before?
A. Asks, and asks again if in doubt
B. Takes clues from body language and/or hesitation
C. Asks the person to first swim in shallow water
D. Any or all of the above as appropriate
- 20.3** During the swim classification test, who is the participant's buddy?
A. The next Scout in line for that particular test
B. The unit leader
C. The test administrator
D. No one

Swimming Skills and Safety

Section





Chapter

6

Safe Swim Defense

All swimming activities in Scouting are required to follow the eight basic principles known collectively as the Safe Swim Defense plan. The elements of Safe Swim Defense were formulated during the 1930s through careful study of swimming emergencies. At the 1953 National Scout Jamboree in California, thousands of Scouts swam in the ocean with the plan in place. Water-safety consultants cautioned BSA officials to expect a large number of drownings, based on public statistics. There were none. Small refinements have been made to the plan over the years, but the basics have not changed. The emphasis has always been on prevention. A unit that follows the plan can expect a safe, enjoyable experience.

A summary of Safe Swim Defense was provided in Chapter 3. The complete text is given here in bold type with additional explanatory material in regular print.

BSA groups shall use Safe Swim Defense for all swimming activities. Adult leaders supervising a swimming activity must have completed Safe Swim Defense training within the previous two years. Safe Swim Defense standards apply at backyard, hotel, apartment, and public pools; at established waterfront swim areas such as beaches at state parks and U. S. Army Corps of Engineers lakes; and at all temporary swimming areas such as a lake, river, or ocean. Safe Swim Defense does not apply to boating or water activities such as waterskiing or swamped boat drills that are covered by Safety Afloat guidelines. Safe Swim Defense applies to other nonswimming activities whenever participants enter water over knee deep or when submersion is likely, for example, when fording a stream, seining for bait, or constructing a bridge as a pioneering project. Snorkeling in open water requires each participant to have demonstrated knowledge and skills equivalent to those for Snorkeling BSA in addition to following Safe Swim Defense. Scuba activities must be conducted in accordance with the BSA scuba policy found in the *Guide to Safe Scouting*. Because of concerns with hyperventilation, competitive underwater swimming events are not permitted in Scouting.

Safe Swim Defense training may be obtained from my.scouting.org, at council summer camps, and at other council and district training events. Additional information on various swimming venues is provided in the *Aquatics Supervision* guide available from council service centers.

1. Qualified Supervision

All swimming activity must be supervised by a mature and conscientious adult age 21 or older who understands and knowingly accepts responsibility for the well-being and safety of those in his or her care, and who is trained in and committed to compliance with the eight points of BSA Safe Swim Defense. It is strongly recommended that all units have at least one adult or older youth member currently trained in BSA Aquatics Supervision: Swimming and Water Rescue or BSA Lifeguard to assist in planning and conducting all swimming activities.

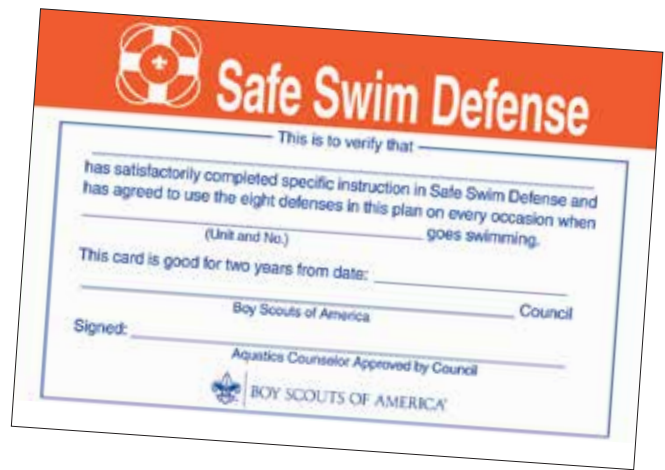

The purpose of this publication is to provide the unit leader with sufficient information to confidently know when he or she meets the expectations set forth in the first point. This book also serves as the text for training in Swimming and Water Rescue. Check with your council service center for course offerings.

2. Personal Health Review

A complete health history is required of all participants as evidence of fitness for swimming activities. Forms for minors must be signed by a parent or legal guardian. Participants should be asked to relate any recent incidents of illness or injury just prior to the activity. Supervision and protection should be adjusted to anticipate any potential risks associated with individual health conditions. For significant health conditions, the adult supervisor should require an examination by a physician and consult with the parent, guardian, or caregiver for appropriate precautions.

This important item is shared with Safety Afloat and was covered in detail in Chapter 4.

3. Safe Area

All swimming areas must be carefully inspected and prepared for safety prior to each activity. Water depth, quality, temperature, movement, and clarity are important considerations. Hazards must be eliminated or isolated by conspicuous markings and discussed with participants.

- **Controlled Access:** There must be safe areas for all participating ability groups to enter and leave the water. Swimming areas of appropriate depth must be defined for each ability group. The entire area must be within easy reach of designated rescue personnel. The area must be clear of boat traffic, surfing, or other nonswimming activities.

- **Bottom Conditions and Depth:** The bottom must be clear of trees and debris. Abrupt changes in depth are not allowed in the nonswimmer area. Isolated underwater hazards should be marked with floats. Rescue personnel must be able to easily reach the bottom. Maximum recommended water depth in clear water is 12 feet. Maximum water depth in turbid water is 8 feet.
- **Visibility:** Underwater swimming and diving are prohibited in turbid water. Turbid water exists when a swimmer treading water cannot see their feet. Swimming at night is allowed only in areas with water clarity and lighting sufficient for good visibility both above and below the surface.
- **Diving and Elevated Entry:** Diving is permitted only into clear, unobstructed water from heights no greater than 40 inches. Water depth must be at least 7 feet. Bottom depth contours below diving boards and elevated surfaces require greater water depths and must conform to state regulations. Persons should not jump into water from heights greater than they are tall, and should jump only into water chest deep or greater with minimal risk from contact with the bottom. No elevated entry is permitted where the person must clear any obstacle, including land.
- **Water Temperature:** Comfortable water temperature for swimming is near 80 degrees Fahrenheit. Activity in water at 70 degrees or less should be of limited duration and closely monitored for negative effects of chilling.
- **Water Quality:** Bodies of stagnant, foul water, areas with significant algae or foam, or areas polluted by livestock or waterfowl should be avoided. Comply with any signs posted by local health authorities. Swimming is not allowed in swimming pools with green, murky, or cloudy water.
- **Moving Water:** Participants should be able to easily regain and maintain their footing in currents or waves. Areas with large waves, swiftly flowing currents, or moderate currents that flow toward the open sea or into areas of danger should be avoided.
- **Weather:** Participants should be moved from the water to a position of safety whenever lightning or thunder threatens. Wait at least 30 minutes after the last lightning flash or thunder before leaving shelter. Take precautions to prevent sunburn, dehydration, and hypothermia.
- **Life Jacket Use:** Swimming in clear water over 12 feet deep, in turbid water over 8 feet deep, or in flowing water may be allowed if all participants wear properly fitted, Coast Guard–approved life jackets and the supervisor determines that swimming with life jackets is safe under the circumstances.

The detailed application of some Safe Swim Defense principles, such as area safety, depends on location. Less effort is needed to ensure area safety if the unit takes advantage of established swimming areas, but temporary swimming areas may also be used with appropriate preparation.

Established swimming areas include public pools and waterparks; lake and ocean beaches maintained by federal, state, or local agencies; and private residential, apartment, and hotel pools. Some will have trained lifeguards on duty; others will not. Avoid venues where crowds hinder supervision.

Temporary swimming areas may be set up on the shores of lakes, quarries, rivers, or oceans, or be laid out in relation to a boat anchored away from shore. In areas not designed and regularly maintained for swimming, unit leadership should use a limited number of skilled swimmers to systematically examine and prepare the area. The buddy system and rescue personnel must be in place anytime anyone is in the water during area setup.

Diving boards, water slides, rope swings, floats, and other play equipment must meet state requirements for construction and supervision. Established areas should have signs warning against diving into shallow water. In the absence of such signs, all participants should be cautioned against possible injuries caused by impact with the bottom or the water. Dives into shallow water, competitive-style dives, or cliff dives are not allowed. Diving areas must be clear of other swimmers.

There is no set height from which a feetfirst entry is always safe below that height and always risky an inch above the limit. Those learning to swim may be asked to jump feetfirst from the side into depths where their feet will touch the bottom. For any heights above a few inches, the water must be deep enough that contact is not made with the bottom. The unit leader should carefully assess the safety of any activity, such as an abandon-ship drill, whenever the height of a jump exceeds the height of the person.

4. Response Personnel (Lifeguards)

Every swimming activity must be closely and continuously monitored by a trained rescue team on the alert for and ready to respond during emergencies. Professionally trained lifeguards satisfy this need when provided by a regulated facility or tour operator. When lifeguards are not provided by others, the adult supervisor must assign at least two rescue personnel, with additional numbers to maintain a ratio of one rescuer to every 10 participants. The supervisor must provide instruction and rescue equipment and assign areas of responsibility as outlined in this book. The qualified supervisor, the designated response personnel, and the lookout work together as a safety team. An emergency action plan should be formulated and shared with participants as appropriate.

If the other elements of Safe Swim Defense are in place, water rescues will seldom be needed. Most lifeguards at Scout summer camps, many of whom work several seasons, are never called upon to make a rescue. The same should be true at unit swims. Even so, there is always some chance of an unexpected medical emergency or other situation that could incapacitate a person in the water. Fortunately, rescues in a controlled situation are relatively safe, simple, and easy to learn. Danger could arise if a would-be rescuer is a poor swimmer ill-trained and ill-equipped for the situation, or if water conditions are hazardous. However, hazardous water situations would violate the third tenet of Safe Swim Defense and should not be present at a unit swim site. Chapter 9 will alert the reader to skills that should be mastered to ensure victim and rescuer safety, the equipment that supports those skills, and situations that should be included in emergency action plans. Older youth and adults who have completed the Lifesaving merit badge, BSA Swimming and Water Rescue, or BSA Lifeguard requirements are candidates for response

personnel. Other good swimmers may be used to maintain the required 1-to-10 ratio if coached in basic surveillance and rescue techniques. The line-and-tender procedure for the First Class rank is one such technique.

Adult leaders, including the qualified supervisor, may serve as response personnel for an entire activity that is not too long. Short breaks in concentration are provided during buddy checks. If youth are used, they will generally need to be rotated so that they too may enjoy the activity. The emergency action plan may specify that response personnel with more training will handle special situations, such as a spinal injury, whereas all response personnel may respond when a reaching rescue is indicated. Response personnel will generally work as buddy pairs, with each buddy monitoring the other.

5. Lookout

The lookout continuously monitors the conduct of the swim, identifies any departures from Safe Swim Defense guidelines, alerts response personnel as needed, and monitors the weather and environment. The lookout should have a clear view of the entire area but be close enough for easy verbal communication. The lookout must have a sound understanding of Safe Swim Defense but is not required to perform rescues. The adult supervisor may serve simultaneously as the lookout but must assign the task to someone else if engaged in activities that preclude focused observation.

Failure of timely recognition of a drowning situation is a common factor in the rare fatalities that occur where trained lifeguards are on duty. At public facilities, it is not uncommon for a single guard to scan an area that contains several dozen swimmers of various abilities.



Safe Swim Defense adds an extra margin of safety by increasing the likelihood that a person in trouble will quickly be noticed. The ratio of watchers to swimmers is high, and there is redundancy in surveillance. A buddy looks after a partner, multiple response personnel watch assigned areas, and a lookout watches overall.

6. Ability Groups

All youth and adult participants are designated as swimmers, beginners, or nonswimmers based on swimming ability confirmed by standardized BSA swim classification tests. Each group is assigned a specific swimming area with depths consistent with those abilities. The classification tests should be renewed annually, preferably at the beginning of the season.

- Swimmers pass this test: Jump feetfirst into water over the head in depth. Level off and swim 75 yards in a strong manner using one or more of the following strokes: sidestroke, breaststroke, trudgen, or crawl; then swim 25 yards using an easy, resting backstroke. The 100 yards must be completed in one swim without stops and must include at least one sharp turn. After completing the swim, rest by floating.
- Beginners pass this test: Jump feetfirst into water over the head in depth, level off, and swim 25 feet on the surface. Stop, turn sharply, resume swimming, and return to the starting place.
- Anyone who has not completed either the beginner or swimmer tests is classified as a nonswimmer.
- The nonswimmer area should be no more than waist to chest deep and should be enclosed by physical boundaries such as the shore, a pier, or lines. The enclosed beginner area should contain water of standing depth and may extend to depths just over the head. The swimmer area may be up to 12 feet in depth in clear water and should be defined by floats or other markers.

Details for administering the swim classification tests were covered in Chapter 5. Anyone may stay in the nonswimmers' area without taking a test. If conducting swim classification tests is not practical for a special occasion, then everyone may be classified by default as a nonswimmer and accommodated in an enlarged shallow-water area. Areas for the three ability groups

only need to be specified for those groups that are present. For example, if a unit has only nonswimmers and swimmers, there is no need to define a beginner area. If a small pool is everywhere less than 5 feet deep, and the unit has only beginners and swimmers, then the entire pool can be a single area.

7. Buddy System

Every participant is paired with another. Buddies stay together, monitor each other, and alert the safety team if either needs assistance or is missing. Buddies check into and out of the area together.

- Buddies are normally in the same ability group and remain in their assigned area. If they are not of the same ability group, then they swim in the area assigned to the buddy with the lesser ability.
- A buddy check reminds participants of their obligation to monitor their buddies and indicates how closely the buddies are keeping track of each other. Roughly every 10 minutes, or as needed to keep the buddies together, the lookout, or other person designated by the supervisor, gives an audible signal, such as a single whistle blast, and a call for "Buddies." Buddies are expected to raise each other's hand before completion of a slow, audible count to 10. Buddies who take longer to find each other should be reminded of their responsibility for the other's safety.
- Once everyone has a buddy, a count is made by area and compared with the total number known to be in the water. After the count is confirmed, a signal is given to resume swimming.

The supervisor must establish a system for tracking everyone who enters the water and their ability. Any system that identifies each swimmer, his or her buddy, and their ability group is sufficient. A handwritten list on a leader's clipboard is easy and adequate. Buddy boards and tags are useful when more than one unit is involved in a district or council activity. Everyone in the area has a buddy and is counted as part of a buddy check, including the lookout and response personnel. If the number of participants is odd, there may be one triple assigned as buddies.

8. Discipline

Rules are effective only when followed. All participants should know, understand, and respect the rules and procedures for safe swimming provided by Safe Swim Defense guidelines. Applicable rules should be discussed prior to the outing and reviewed for all participants at the water's edge just before the swimming activity begins. People are more likely to follow directions when they know the reasons for rules and procedures. Consistent, impartially applied rules supported by skill and good judgment provide steppingstones to a safe, enjoyable outing.

Like the bread that holds together a sandwich, discipline and qualified supervision are the foundation and the

cover that make safe Scouting a reality. Scouts are accustomed to following rules in other situations and will likely also be well-behaved during swimming events. That is particularly true if the Scouts are reminded of their dual responsibility for their own safety and that of others in the unit. Likewise, youth leadership should share in decisions and guidance. However, youthful exuberance may at times cause momentary lapses in attention; fun and a sense of adventure can overwhelm common sense. Dealing with such situations is a learning experience for youth and leaders, but leaders should realize that youngsters cannot always be expected to act rationally in the interest of their own safety. Adult leaders should therefore accept that they, not the Scouts, are ultimately responsible for implementing BSA rules and procedures.



Divide and Conquer. The effectiveness of supervision and discipline, as well as instruction, may depend on group size. Certain activities are often easier to oversee with a patrol of eight Scouts and two adults rather than with an entire troop of 30 Scouts and three adults. Particularly when trying things for the first time, leaders may wish to subdivide large groups to enhance the experience for all. Subdividing a large group is also useful when the activity requires special gear, such as snorkeling equipment, that is in short supply. Scouts having to wait a long time for their turn at an activity naturally become bored and restless. That, in turn, may lead to discipline problems.





Swimming Locations

The application of Safe Swim Defense principles varies somewhat based on the setting. Means for marking areas for ability groups at an ocean beach differ from those at a small above-ground pool. Rescue equipment available on a backpacking trip may vary from that on a canoe trip. Professional medical assistance may be minutes away from an urban backyard pool but hours away from a remote camping site. So long as the basic concepts of each point of Safe Swim Defense are in place, flexibility is allowed in their execution. The following review of common settings should help the unit leader adapt the principles to various situations. All eight points of Safe Swim Defense apply at all times. If an item is not discussed under a particular heading, it is common to other situations that have already been covered.

Private Pools

The most common drowning incident at private pools occurs when an unsupervised toddler enters the water. A second risk factor arises from headfirst dives into shallow water. Otherwise, the small size, shallow depth, and clear water provide a safe venue. Rescues, if needed, are relatively simple, and EMS services are often close at hand. However, the familiarity and apparent simplicity of the setting can lead to complacency. Unobserved drownings occur at private pool parties even when several people are present. As always, it is essential for supervisory personnel to maintain close, uninterrupted surveillance of the area. Many private pools are too small to comfortably accommodate an entire pack or troop at once. Rather than allow Scouts to move at will from one backyard activity to another, tracking those in the water may be easier if only a single den or patrol is allowed in the water at one time.

Appropriate rescue equipment includes reach poles and flotation devices, such as a rescue tube or ring buoy. The emergency action plan should cover extension assists for active victims, wading rescues for unconscious victims, and the location of a phone for calling emergency services. The “tailgate” review before the swim should include the importance of watching your buddy, signals and procedures for buddy checks and emergencies, and prohibition of headfirst entry.



Considerations for private in-ground pools:

- Too shallow for diving
- Swimmer and beginner areas may be combined if depth less than 6 feet
- Will need rescue equipment such as reach pole and flotation aid
- Extension assists from the side may suffice for conscious victims; wading assists may reach unconscious victims
- Lookout may be placed at shallow end with two response personnel on opposite sides at deep end
- Lines across pool provide area boundaries but should not pose tripping hazards
- EMS response time often short

Considerations for above-ground pools:

- Similar to private in-ground pools; e.g., no diving
- The entire pool may be a single ability area, given the fixed depth and small size
- Fixed depth may be too deep for short nonswimmers, who may need approved flotation devices

If the pool does not have a raised deck:

- May need to station lookout on a temporary stand, such as a stepladder, with guard team at entry ladder for visibility
- Removal of large incapacitated person from the pool needs consideration





Apartment and Hotel Pools

Semiprivate pools without lifeguards on duty are similar to private pools but are shared with others. Defining areas for ability groups with lines across the pool may not be practical. In that case, instruct nonswimmers not to go past a certain point, such as a ladder, and station the lookout at that location as a reminder and to enforce the rule. Many newer pools have a maximum depth of 5 feet, so separate beginner and swimmer areas may not be needed. If the unit is small enough, and the pool not crowded, unit safety team members can do frequent head counts in lieu of formal buddy checks. Otherwise, a visual signal for a buddy check may be substituted for an audible one, with the unit all meeting at one end of the pool. (Recall that the primary purpose of a buddy check is to reinforce the concept of each person watching another. A slightly prolonged procedure still accomplishes that goal. Buddy checks are not conducted often enough to serve as the primary indication that a person has submerged. Prompt recognition of an emergency is the joint responsibility of the buddy, the response personnel, and the lookout.)



Most states require semiprivate pools to post rules, depth markers, no-diving signs, and rescue equipment such as a reach pole (or shepherd's crook), a ring buoy, and sometimes a backboard. Before the swim, make sure the equipment is in working order. Determine how best to summon EMS—by cell phone, through an attendant, or

by house phone to the office, for example. Make sure you know how to provide directions. The dispatcher may not be able to bring up your location if a cell phone is used, and rescuers may need instructions on how to find the pool from the main entrance. The emergency action plan should include how to deal with situations involving those in the pool who are not members of the unit.

Considerations for hotel and apartment pools:

- Dealing with other users
- Alternate means to define ability areas
- Checking rescue equipment
- How best to summon EMS

Established Lakefront Swimming Areas

Swimming is often done in lakes, ponds, dammed rivers, and quarries. Although clear-water springs can provide water quality and clarity close to that of a swimming pool, visibility is impaired in many natural bodies of water. In clear water, swimmers and those in trouble may be tracked underwater, and a search for a submerged person takes only seconds when safety team members are positioned with clear views of the surface and the bottom. In murky water, the margin for error is reduced. Prompt rescue requires that an emergency is spotted before a person submerges. Locating a submerged person in turbid water may take more time than the victim has. Every aspect of Safe Swim Defense needs rigorous attention.

Public lakefront swimming areas are maintained at many state and federal parks. Even though such areas often do not have lifeguards on duty, they may be equipped with changing facilities, sandy beaches, floating platforms, buoys that restrict boating, and other amenities that make them reasonable choices for a unit swim.



If possible, a unit should conduct its swim in an otherwise unoccupied portion of a public beach within the designated swimming area. Before the swim, good swimmers should check depths and set up ability group areas accordingly, using already established buoy lines as appropriate.

The unit may need to bring its own rescue equipment to a lakefront swimming area. Reach poles will be of limited usefulness on a sloping beach. Instead, equip rescue personnel with lines and flotation devices. Emergency action plans need to consider the possibility of submerged victim recovery. To make that task easier, the adult leader may wish to limit the extent of the swimmer area and the depth to less than the 8 feet allowed in Safe Swim Defense. Depending on the area and the experience of the safety team, it may be prudent to have all participants wear life jackets. Check with park personnel on the availability of EMS.

Considerations at unguarded public lakefronts:

- Dealing with other users
- Checking depths
- Defining ability areas using existing markers
- Submerged victim recovery
- How to summon emergency aid

Rarely, a person will be apprehensive of turbid water even though he or she can swim well in a pool. Such people will probably self-limit activities in a natural body of water and may need patient encouragement along with remedial exercises before they become comfortable with a swim test or boat swamping exercise. They should not be assigned as response personnel if they are uncomfortable with the setting.

Temporary Lakefront Areas

A unit may take advantage of lakefront areas at a private residence, near a remote campsite, or on a break during a lake canoe trip. Setting up a safe swimming area in such settings obviously requires more effort than using a purpose-built pool or a beach maintained in a park. However, the benefits are often worth the effort, and the challenge can strengthen unit teamwork.

The first task is to find a promising location free from obvious pollution or other hazards with easy access to the water. A sandy beach sloping into shallow water is ideal. Muddy bottoms with high weeds or quarries with steep sides may not be suitable. Location scouting is generally done in advance by a small group rather than by the complete unit ready to swim.



- **Select an area free from obvious hazards—this one is not.**

Next, the area needs to be checked for appropriate depths and underwater hazards. Safe Swim Defense principles apply when checking the area. Everyone in the water must be classified as a swimmer with a buddy, and personnel onshore should be prepared to provide emergency assistance.

In shallow water, have a small group of swimmers wearing shoes link hands in a line from shortest to tallest. The tallest wades out perpendicular to shore, and then the line moves parallel to the shore while shuffling their feet. If necessary, several passes are made until the area is searched to the extent of standing depth. An occasional limb or piece of trash can be removed. If the area is full of debris, then another site needs to be found.





- **Use a line of swimmers to check shallow water.**

As the waders cross the area, note approximately where waist-deep, chest-deep, and chin-deep water occurs. Bottom contours are seldom ideal. If the water is too shallow too far out, then rescuers on the shore may be too far from the swimmers to be effective. If the water drops off too rapidly, then nonswimmer and beginner areas may not be big enough to accommodate those groups. However, only those areas for which there are participants need to be defined. If all in the unit are swimmers, then there is no need to set up the other areas.

If the water clarity is good enough, two or four swimmers can survey deeper water for trees or other hazards from the surface. One or two such obstacles can be avoided when the swimming area is marked. Numerous obstacles make the area unsafe. A single pair of good swimmers should be used to check the depth. One swimmer should make a feetfirst surface dive with shoes on while the other watches from the surface. Once the water is too deep for the swimmer to easily reach bottom, that defines the maximum extent of the swimming area. Twelve feet is the recommended maximum depth for clear water in Safe Swim Defense, but the working definition of a safe depth is one where the rescue personnel can reliably make it to the bottom.

If the bottom can't be seen from the surface, determine whether there is sufficient area in water less than chin deep to provide adequate room for the desired ability groups. Consider extending the area along the shore rather than out from shore. If an adequate swimming area can be established in turbid water at chin deep or less, it may be prudent to stop at that point. Deep water is not essential to a fun swim.



- **If needed, use two swimmers with line to check deep water.**

If a bit more area is needed because the bottom slopes steeply, and the bottom has been clear of debris out to chin deep, then murky water over the head can be surveyed by a single pair of good swimmers. For extra safety, the feetfirst diver should be loosely attached to a line with a large bowline across the shoulders. The diver's buddy supports the line at the surface, but the other end of the line is held by another buddy pair stationed onshore or in shallow water. To avoid the possibility of entanglement, the diver should work out in straight lines from shallow water using closely spaced, feet first vertical dives. That is, the diver should not attempt to swim along the bottom looking for obstacles.



- **Use lines and floats to define nonswimmer and beginner areas.**

Once the entire area is surveyed and determined to be free of hazards, then the advance group needs to establish boundaries for the ability groups. Lines for nonswimmer and beginner areas can be extended from shore to poles stuck in the bottom, stretched parallel to shore to another support, and then returned to shore. Floats may be made from balloons, plastic bottles, life jackets, or even sticks. Twine is useful for anchor line and can be used with

additional floats as boundary lines. Brightly colored ¼-inch floating polypropylene rope may be a better choice. A physical boundary is needed to prevent a nonswimmer from inadvertently swimming into water over the head or a beginner from swimming too far out. The outer bounds of the swimmer area only need to be marked by floats. Reusable bags filled with rocks or sand may be used as anchors.

- **Use floats to define the swimmer area.**

Swimmers need access to deep water without crossing the nonswimmer and beginner areas, and may also enjoy an area of shallow water for their own use. A “traditional” layout has a narrow corridor for the swimmers along the edge of the beginner and nonswimmer areas. If available,



fixed or floating docks may be used as part of the area boundaries, with access to the areas from the dock rather than the shore. A detached floating dock may also be used as a platform for swimmers and rescue personnel. If docks are used, areas under them should be off limits.

Bottom conditions may dictate the size of the areas, but each swimmer should have roughly 50 square feet of space. The areas should also be of a size and shape that guards can easily reach all points. If a line-and-tender team is assigned as primary rescue personnel, then no point in the combined areas should be beyond the length of the rescue line. The areas may be larger if multiple guard teams are used, either onshore or in a boat.



- **Ensure entire area is in easy sight of the lookout and easily accessible to rescuers.**



Some bodies of water, particularly lakes formed by dams, are bounded in areas by rock cliffs and ledges. Such sites often tempt youth to test their mettle by diving or jumping into the water from as high as possible. Recall that diving is allowed from a maximum height of 40 inches into **clear, deep** water. There is no magic height above the water at which feetfirst entry goes from safe to hazardous, but Safe Swim Defense guidelines caution against jumping from heights greater than a person is tall.



- **Recall guidelines for elevated entry.**

At remote settings, the emergency action plan needs to include means to summon and connect with outside help.

Note: Cell phones do not work in all areas.

Rivers

After a hard day of paddling, a dip in the river can be refreshing, but safe swimming in a flowing river requires an understanding and appreciation of river currents. Currents define how depths vary across a river as well as presenting the potential hazard of pushing a swimmer downstream. Free-flowing rivers as unit swim sites are best suited to Scout or Venturing units with a majority of members classified as **swimmers**. Such rivers are not recommended sites for Cub Scout swimming or for units with a large percentage of poor swimmers.

Because rivers differ significantly from still-water bodies and from one to another, an overview of river properties is useful before discussing how to set up a safe swim area in a river. There will be numerous situations to avoid, but also several options for a safe area. Conducting a safe swim in a river requires the unit leader to exercise more judgment than setting up a safe swim in a small backyard pool. If all factors do not fall into place, the unit leader should find another area or cancel the swimming activity.

Rivers change dramatically between low water and flood stage. At low water in a large river, there may be more than one channel separated by sandbars. The main channel may still have significant water flow, but subsidiary channels tend to be slow and shallow. The secondary channels may be good candidates for a simple wading area. All ability groups can splash around and cool off even if the water is not deep enough for swimming.

Rivers at flood stage are dangerous. Do not swim or wade during high flows—when the river is out of its banks, for example. Debris flowing past is also a sign of high water.

River levels between extremes can be deceptive. Even an apparently gentle river without waves can conceal a major current. Look for partially submerged vegetation at the edge of the river to determine whether it is higher than normal. Also monitor the water level during a swim. Rains or dam releases far upstream can quickly increase currents and flows.

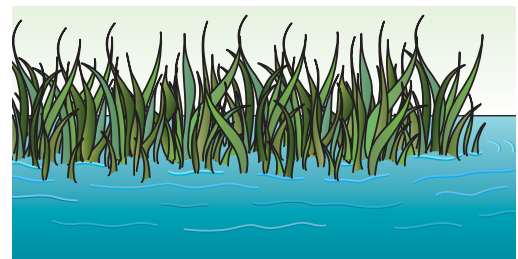
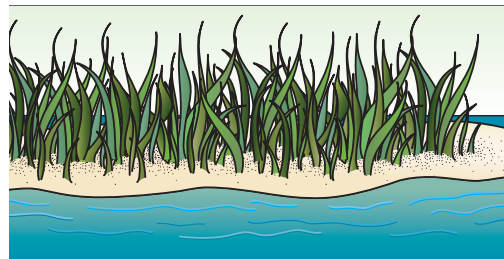
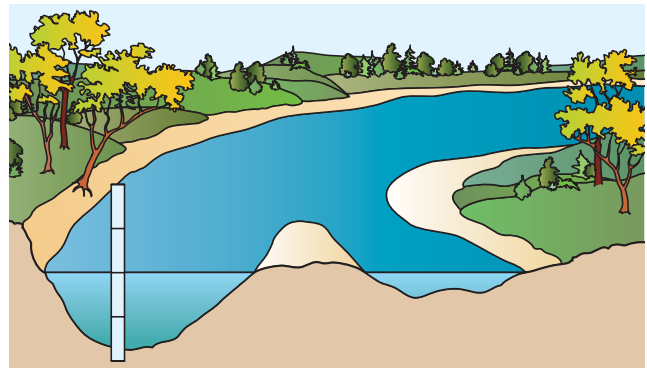
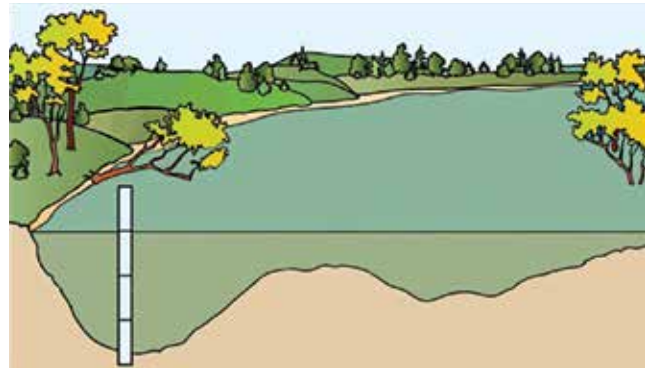
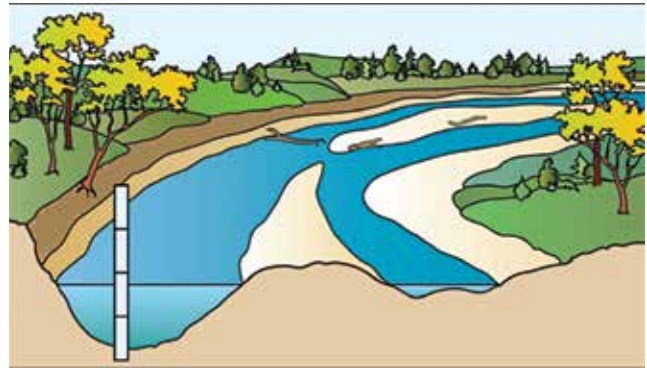

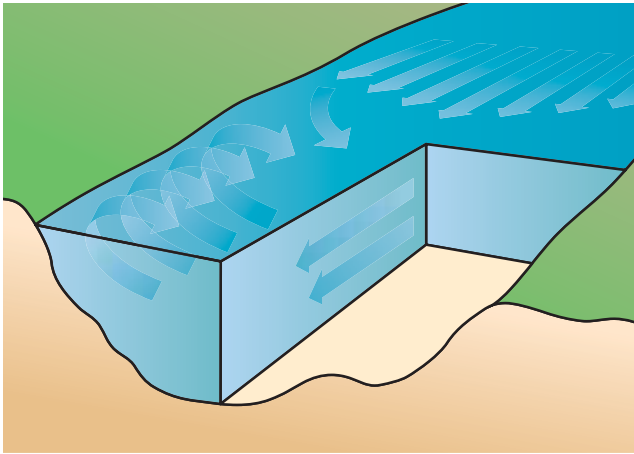

Although ever changing, river currents do behave in generally predictable ways. When an unobstructed river flows straight, the deepest water and fastest current will be near midstream. The faster water in the center of the channel draws water from the edges along the surface. A swimmer floating near the river's edge will slowly be drawn into the main current.

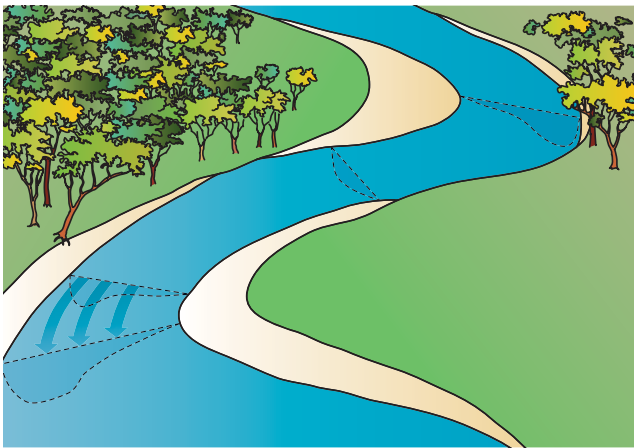

When the river makes a turn, the deepest water and fastest current will be on the outside of the bend. A steep bank and undercut trees often characterize the outside of the bend; the inside of the bend may have shallow, relatively slow water. Swimmers unfamiliar with rivers may get into trouble because they do not realize that both the depth of the water and the strength of the current can vary rapidly as they wade out from the flat, sandy area on the inside of a bend. If an unwary swimmer, or a capsized boater, is caught in a river current free of obstructions, he or she should swim for shore, ideally toward the side on the inside of a bend. Because of the current, the swimmer will actually move downstream at an angle to the shore.

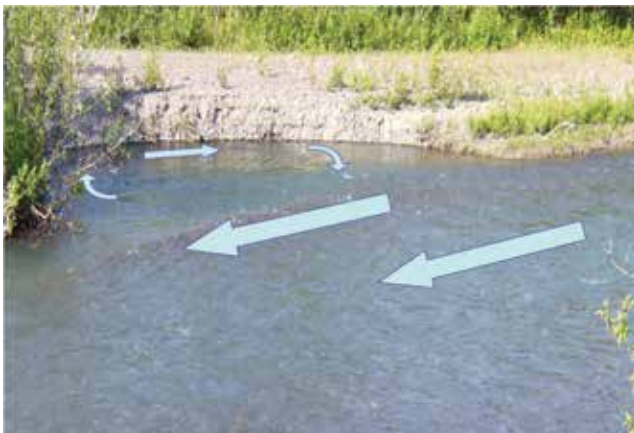

If the bend in the river is sharp, a countercurrent, or **eddy**, may form on the backside of the turn, as shown in the illustration. That is, the water actually flows upstream. Crossing the eddy line may cause problems for unwary swimmers and boaters. (Learn more about eddies in Chapter 19 on river boating.)



Water depths in many small rivers are too shallow for swimming and boating except in pools created by small dams constructed for irrigation or recreation. Such dams impede but don't stop the flow. The pools may be very long even behind a low dam and generally make good swimming areas. However, be aware that bottom contours and debris may change from one visit to the next, particularly after floods. In dry summer months, the water may fall below the outlet and become stagnant and unfit for swimming.

When the water is flowing, the current in the pool is generally slight, but nevertheless present. Swimmers should stay well away from the outlet, which might be a large, barely submerged pipe, an adjustable chute at the bottom of the dam, or a small cut and spillway with water flowing over the top of the dam. In some cases, the entire length of the dam serves as the outlet. Such dams were designed to dissipate the energy of the water by recirculating the flow back toward the dam. That creates an extremely dangerous situation called a **hydraulic**,

also known as a “drowning machine.” A person caught between the dam and the boil line will be endlessly tumbled. The only ways out—both risky—are to work toward the side abutments or to dive for the bottom in search of a downstream flow not blocked by debris or design barriers. **Never swim near a hydraulic.**

A whitewater rapid is no place for a swimmer. However, some whitewater rivers are the “pool and drop” variety. Most of the change in elevation occurs near stepped falls followed by sometimes lengthy sections of relatively slight gradient. The pools between the drops can be good places for a swimming break, provided the current is not strong enough to sweep swimmers into the next rapid.

To establish a safe swim area in a river, first consider the current. Avoid currents strong enough to sweep swimmers off their feet and places where a weak current is likely to carry a swimmer into an area of danger, such as a strainer, a hydraulic, or a series of rapids. Look for safe areas on slow-moving rivers on the inside of a bend, in a pool between small drops, or behind a dam that has only a slight water flow over a spillway.

A sand or gravel beach on the inside of a river bend makes a likely spot. Locate the swimming area on the upstream side of the beach so that swimmers have the rest of the beach as a safe haven if needed. Check the depth and the current toward the main channel using a good swimmer attached to a line. Make sure the line is held securely: a single person may not be able to hold a swimmer stepping into the current. If the current in the channel is strong enough that swimmers will be moved



downstream, then limit the **swimmers** area outside of the channel. It is not necessary for Scouts to have water over the head in depth for them to cool off and have fun. Safe Swim Defense policies define maximum, not minimum, swimming depths.

Although makeshift buoys or other isolated objects are often sufficient to define a swimmer area, floating lines can provide additional assurance that swimmers remain away from off-limit areas. Stretching a line diagonally across the width of the river is sometimes feasible, but not always practical, particularly if boaters are using the area at the same time. If the depth of the swimmers area

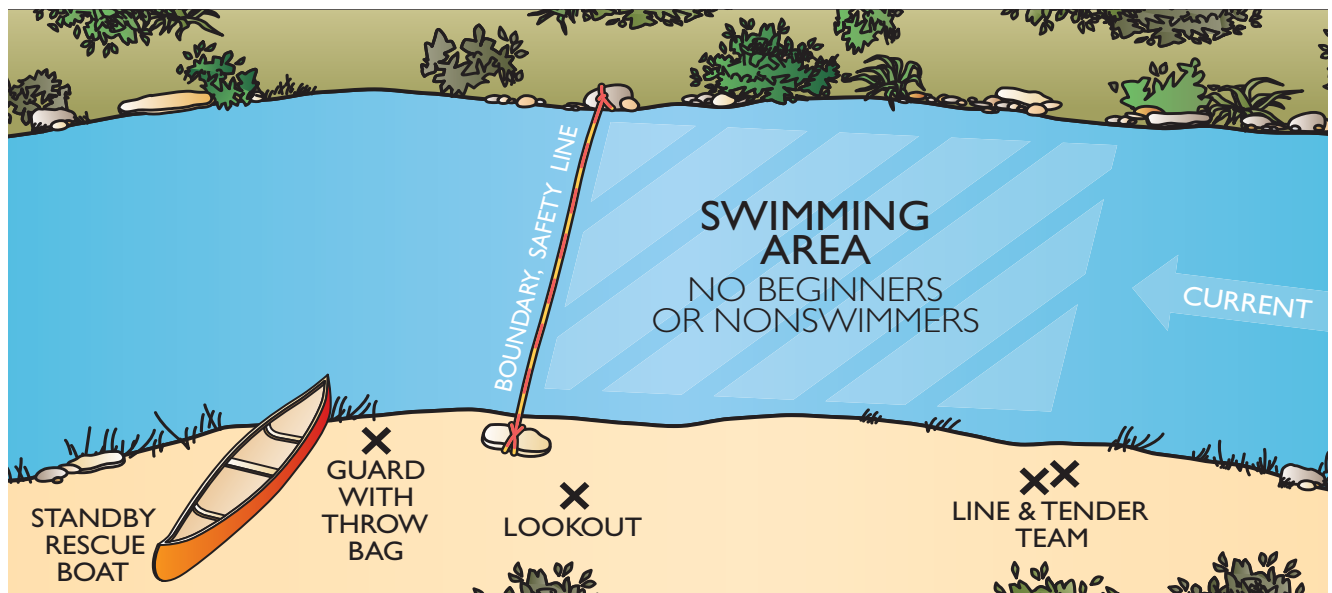

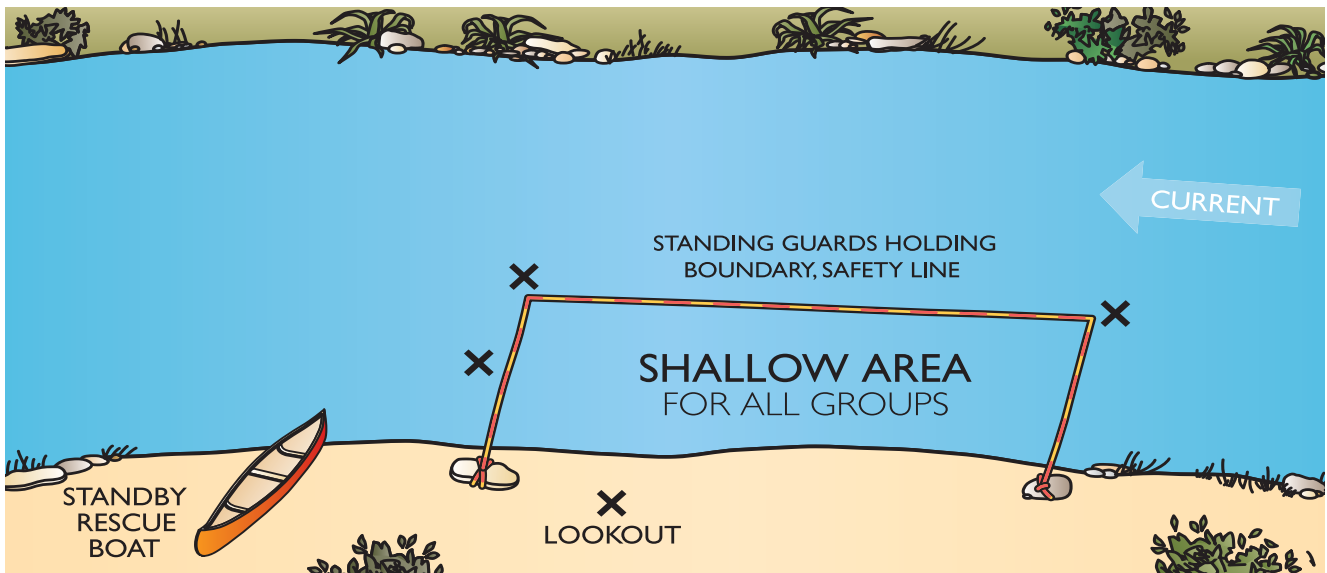

is less than chest deep, then an alternative to anchors is to have the line held by safety personnel. Attach one end of a long line onshore at the downstream end of the area. Have two members of the safety team wade out with the rope to just over waist deep. One person remains there to define the maximum distance from shore and supports the line in place. The other person continues with the line upstream and parallel to the shore. The resulting L-shaped corral defines the swimmers area. If needed, either person can drop the line to assist a person in trouble. Alternately, the line may be pulled toward a distressed swimmer.

Regardless of whether safety personnel are deployed in the water, there should also be a line-and-tender team onshore. Other safety team members can be positioned with a throw bag near the downstream end of the area. If the condition of the bank is such that a swimmer swept downstream by the current cannot easily be followed onshore, then a boat may be kept on standby to retrieve such a person.

A flowing river is less than ideal for a unit with a large percentage of nonswimmers and beginners. However, the technique described above can be used to define a small region of shallow water for a combined nonswimmer/beginner area. In that case, extend the upstream end of the line back to shore to completely enclose the area. Having the bathers wear life jackets will provide an extra margin of safety.

If there is a noticeable current beyond the confines of the established swimmer area, Scouts may well ask permission to jump into the current, float downstream, exit, and repeat. In the proper circumstances, such a natural "waterpark ride"

provides an opportunity to teach river boaters swift-water survival skills in a controlled setting. However, "control" is the key. The downstream area needs to be free of obstacles for a long distance, and there needs to be an easy place to exit. Limit such an activity to **swimmers**, have them wear life jackets, and instruct them to float feetfirst. Allow only one person to "launch" at a time. Make sure the course is within easy reach of a throw bag over the entire route. Also consider putting a "safety line" in the water near the exit.

Ocean

Establishing a safe swimming area in the ocean requires consideration of currents, waves, access, and marine life. Swimming areas need to be separated from surfing or boating activities. Concerns with water clarity, purity, and temperature are similar to other areas.

The twice-daily cycle of high and low tides causes **tidal currents**. In some coastal areas, the main shoreline is separated from the open ocean by a series of barrier bars and islands enclosing shallow bays. The current in tidal channels

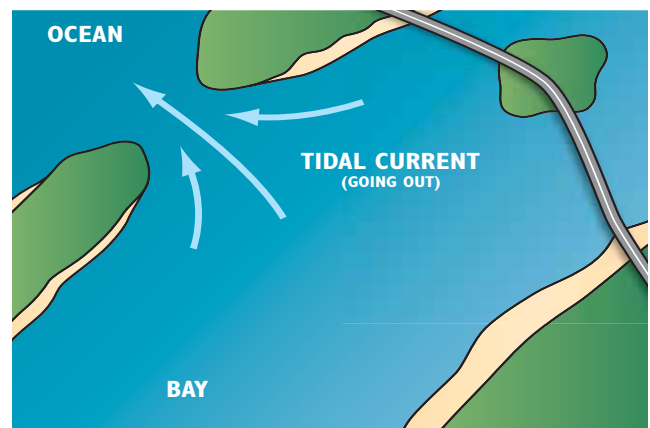

between the islands can be strong enough to wash a human-powered boat or a swimmer out to sea. Avoid swimming in such areas, and be alert to changes in the strength and direction of currents as tides wax and wane.

Longshore currents, also known as **drift** or **lateral currents**, move parallel to the shore. They will not carry a swimmer out to sea, but they can wash an unwary person toward areas of potential danger such as pilings or rip

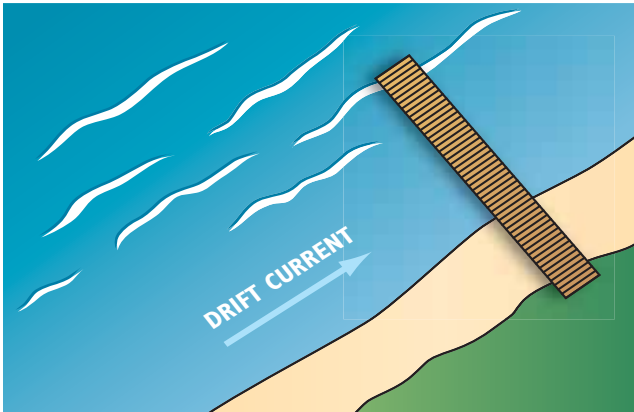

currents. Buddies and safety personnel should check to see if swimmers are drifting along the beach. If so, the swimmers should swim directly toward shore until they are able to wade back to the group. Swimming against the current wastes energy.

In some cases, drift currents run in a "gutter" or trough inside the surf line between the beach and a shallow sandbar. Such holes can present a danger to poor swimmers, particularly shorter children.

Water cast upon the beach by waves must eventually return seaward. In some areas, the water flow is first channeled along the beach and then returned seaward in strong, isolated currents called **rips**. Some rips are relatively fixed in location—along the edges of a narrow bay, for example. Others arise where a break in a sandbar provides a channel for outgoing water. Those currents will change location as sandbars shift. Intense, temporary rips may appear quickly in response to changing conditions, such as a surge produced by a storm moving toward land. Rip currents are fairly narrow and can sometimes be recognized as a strip of foamy, different-colored water that causes a gap in breaking waves. Rip currents are dangerous and should be avoided. They are a contributing factor to many ocean drownings and to most rescues made by ocean lifeguards. At guarded beaches, flags may be used to limit swimming to areas away from rips.

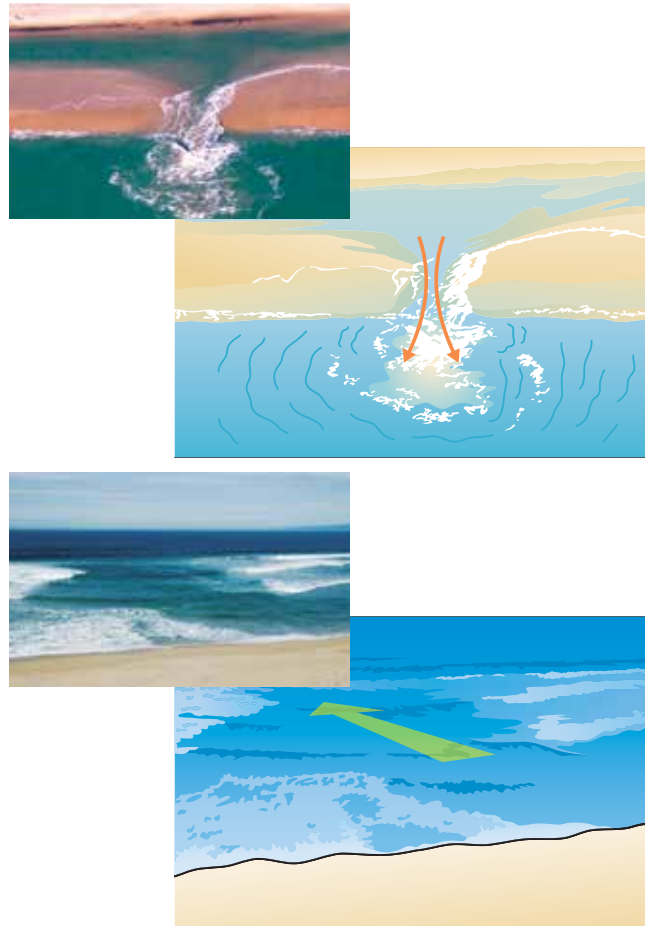

Rip currents can pull unwary swimmers into deep water and sweep them many yards offshore. Poor swimmers may panic and need help after they exhaust themselves trying to swim to shore against the powerful current. Instead, they should swim parallel to shore until they are out of the current. Generally the distance will be short, but may be comparable to a length or two in a pool (25 to 50 yards). In such a situation, it helps to know restful swimming strokes.

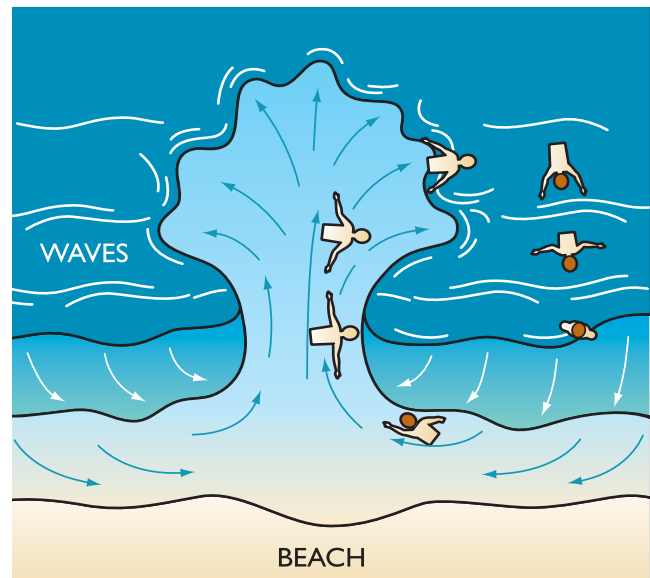

Once out of the current, the swimmer should probe with the legs for the bottom. There may be standing depth on an adjacent sandbar. Otherwise, the swimmer can continue to shore outside of the rip. A discussion of rip currents should be included in the “tailgate” review that precedes a unit swim in any area where they are likely.

Backwash, or runback, is caused when the water cast ashore by a wave flows seaward down the slope of the beach. The flow reverses promptly as the next wave approaches. Backwash is most noticeable on steep beaches. The rushing water can make it difficult for a person to keep his or her footing, but it isn’t normally dangerous, except perhaps for a small child or an inexperienced swimmer. As always, both such groups should be closely supervised. Breaking waves combined with backwash may cause them distress. Backwash may have led to the concept of people being caught in an “undertow” and dragged under. Backwash may knock some people off their feet and push them momentarily seaward, but it does not suck them down and hold them underwater.

Surf is the combination of breaking waves and backwash. Wave strength depends on offshore winds, the steepness of the beach, and whether the tide is in or out. Waves approaching a beach travel as **swells** formed by offshore winds. If the water remains deep all the way to shore, wave energy is not released by breaking, and **surging waves** can cast a swimmer against rocks or piers. Swimmers should avoid surging waves impinging on obstacles.

As the water depth decreases, the waves become higher until they break. **Plunging waves** topple over the wave front with a large, sudden release of energy. Such waves are dangerous for swimmers and a common cause of spinal injuries in the surf. **Spilling waves** occur when the top of the wave tumbles down the wave front. Swimming in small waves spilling on a gently sloping beach is generally less hazardous than swimming in either large plunging waves or waves surging on rocks.



Surging waves



Plunging waves

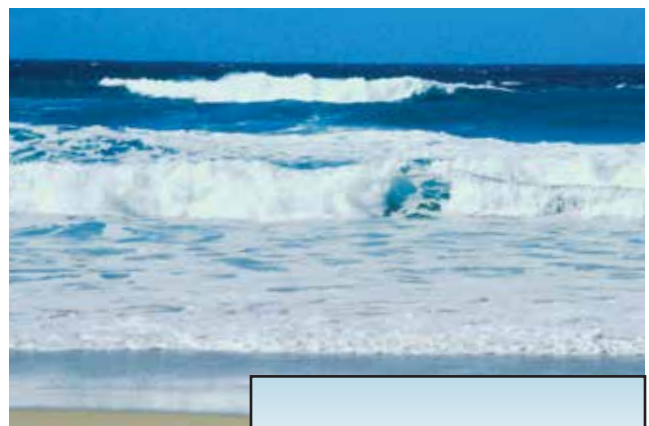
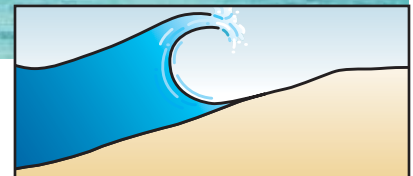

Spilling waves

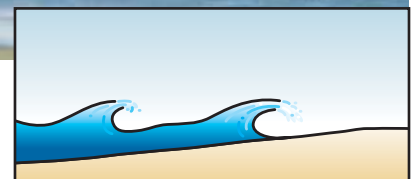



Swells typically break in water depths approximately 1.3 times their height. The difference in depth between a wave trough and peak can be a significant portion of a swimmer's height. Swimmers seeking deeper water against the action of waves should be cautioned against trying to dive under a wave. The likely result is a neck or spinal injury.

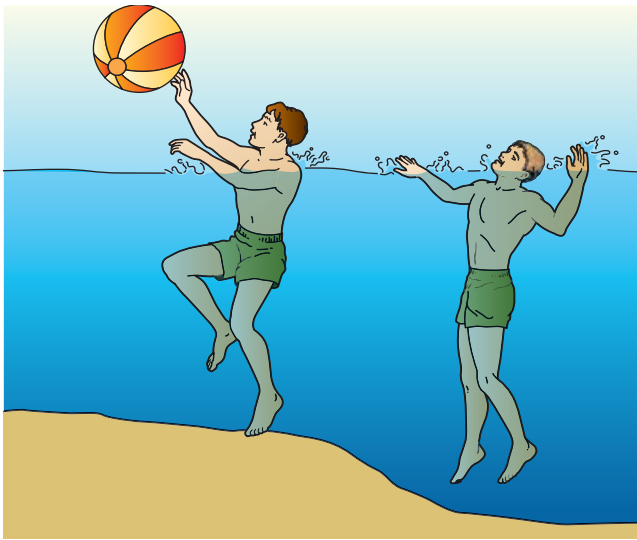

On steep beaches, the action of waves and/or tides may produce an abrupt change in depth known as a **low-tide shelf**. Nonswimmers should be isolated from such a zone when the change in depth is the difference between standing and swimming. That transition point will vary with the tide as well as the height of the bather.

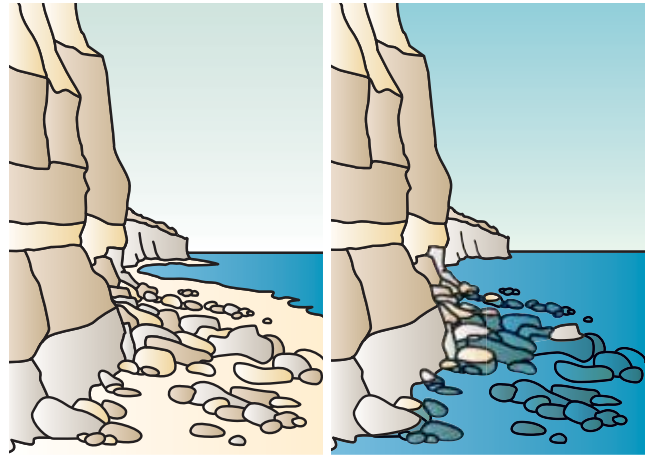

Access to the water on a sandy beach is straightforward, but not all shorelines have large stretches of sand. In some areas, the surf impinges on cliffs at high tide, with small patches of shingle (coarse pebbles) or sand exposed at low tide. Care should be taken when swimming at the base of a cliff during low tide to avoid being trapped against the cliff as the tide comes in.



In other areas, stands of thick mangroves line the shoreline and prevent access. In still other places, the shoreline is composed of ancient rough coral. Stout footwear is needed in that case.



Footwear can also protect against some types of marine life that inflict stings. Rays and urchins have spines that may be embedded in a foot if stepped on. Jellyfish and sea anemones sting by contact with their soft tentacles. Contact with certain types of coral will also result in skin irritation. The result of a sting can range from mild discomfort to a life-threatening allergic reaction. Because of the latter, the unit supervisor should make marine life a consideration in an emergency action plan when swimming in the ocean. At some beaches, warnings against jellyfish and rays will be posted. In a few areas, kelp or other vegetation may be thick enough to pose a hazard by impeding swimming.

Attacks by other types of marine life, such as sharks or crocodiles, are rare in this country but not unknown. In other countries, attacks by marine life may be more prevalent, and stings from box jellyfish may be fatal. Seek advice from locals when swimming in unfamiliar areas.

To establish a safe swimming area at a surf beach, first find an area of safe, easy access away from strong currents. Abide by any posted signs limiting use of the area. If the unit has nonswimmers and beginners, combine them into one group limited to an area shoreward of safety personnel standing where waves crest no more than chest high on the participants. The responders should be aligned with markers on the beach that establish the lateral limits of the



area. If each responder faces the opposite corner of the area, they should be able to see each other and each scan the entire area. The participants may feel more secure if life jackets are worn.

A second rescue team, equipped with a line and a flotation device, should be assigned to watch the swimmer area. Ideally, the outer limits of the swimmer area should be marked with anchored buoys. However, if buoys are impractical, the swimmers should be instructed to stay within a given distance of the guards, say 50 feet, or no farther out than the guards are apart. A buddy check can be called if a buddy pair strays too far out. Water depths where the troughs of the waves are at chest height should be adequate for a swimmer area. However, the depth at a reasonable distance from the safety team will depend on the slope of the bottom.

If a large troop is involved, it may be advisable in some settings to divide the unit into smaller groups, either by swim classifications or patrols, each with its own supervisor, lookout, and response personnel.

Not all ocean beaches have noticeable surf, particularly in bays. Safe Swim Defense specifics at a “non-surf” ocean waterfront are similar to those at a lake or pond. Areas at non-surf beaches where the water clarity approaches that of a pool are well suited for unit swims. Such areas occur along the carbonate platforms of the Florida coast where the Florida National High Adventure Sea Base is located. The water is more likely to be turbid in small bays near the mouths of silt-laden rivers that empty into the western Gulf of Mexico.

Swimming From Boats

There are several situations when a unit, generally small in number, may consider swimming from a boat that is large enough to carry the entire group. Afternoon cruises on a pontoon boat on a local lake or a live-aboard cruise on a large sailboat are examples. Some of the best snorkeling sites are easier to reach by boat than from shore.

Generally, swimming from a boat should be considered only when all members of the unit are classified as BSA swimmers. Otherwise, the group can put ashore and establish a conventional Safe Swim Defense area where everyone can participate.

Swimming from a boat under way is not authorized. Towing people on floats, boards, or skis are separate activities covered in Chapter 26.

The boat should be anchored in an area free of underwater obstructions, such as submerged trees, and away from boat traffic. Ideally, the boat should be anchored in clear water less than 12 feet in depth. If clear water is over 12 feet deep, or if the water is turbid and exceeds 8 feet in depth, then swimming from a boat should only be allowed if properly fitted life jackets are worn in the water. Having everyone wear a life jacket also precludes swimming underwater, which is not allowed in turbid water.

The swimmer area may be defined as an approximate distance from the boat. Somewhere around 50 to 75 feet should be sufficient. It is not necessary to deploy anchored buoys to define the area for a small group,



but the adult supervisor should intervene if a buddy pair abuses the guidelines by continuously pushing the limits. Buddy checks can be used to regroup the swimmers closer to the boat if the group begins to disperse over too large an area.

Swimmers should be able to enter and exit the water easily. That normally requires a boat equipped with a fixed or removable ladder or a swim platform. Don't neglect a plan for rescuers to bring an unconscious person aboard. Jumping feetfirst from the side of the boat should only be allowed into deep water that has been checked for obstructions.

Small swells or weak currents will swing a boat anchored from the bow to face into the direction of water movement, and will also tend to carry swimmers in the same direction. When such forces are present, the designated swimming area should be in front of the boat so that swimmers who become tired or disabled are carried toward the boat rather than away from it. The lookout would then be stationed at the bow. In addition, a long floating line should be deployed from the stern to give those swept past the boat something to grab. Swimming from boats should not be allowed in the presence of large swells and strong currents.

Swimming should be confined to only one direction away from the boat, so that a lookout on the boat can observe the entire group without turning. Ideally, neither the lookout facing the swimmers, nor swimmers facing the boat, should be facing into the sun.

Rescue personnel may be stationed on the boat or in a tender craft. They should be equipped with flotation aids and throwing devices. The distance swimmers are allowed away from the boat may need to be specified in terms of the length of the line in a throw bag. A practice drill at the start of the swim will check that the safety team and the swimmers know how to respond in the event of an emergency.

During a buddy check, swimmers need to find their buddy and tread water in position. It is not necessary to have everyone leave the water to determine if buddies are watching each other and to check the number in the water. A buddy check should also serve to remind the adult supervisor to review weather conditions. Getting everyone to a safe location during a thunderstorm will obviously take more time from an anchored boat than from a backyard pool.

Rescue equipment, personnel placement, emergency drills, and keeping a weather eye are elements of an emergency action plan for swimming from a boat. Emergency planning also needs to consider who handles the boat if the skipper becomes incapacitated and how to contact the nearest emergency services, such as a lake patrol, county sheriff's office, or the Coast Guard. A cell phone may be carried for emergency communication. In coastal areas, marine radios are useful.

Safety procedures for swimming from a boat involve elements of both Safe Swim Defense and Safety Afloat. Emergency action plans for boating excursions are covered more thoroughly in the boating section of this text.

Distance and Competitive Swimming in Open Water

Swimming long distances promotes physical fitness through exercise and conditioning. The **Mile Swim BSA** recognition is one such activity. Long distances may be achieved in a pool or an established waterfront swim area by swimming laps in accordance with Safe Swim Defense policies. The BSA has established additional guidelines if the distance is covered over longer stretches outside an established swimming area:

- The environment for an open-water swim must conform to Safe Swim Defense guidelines regarding hazards such as submerged trees, currents, or boat traffic, as well as water quality, depth, and clarity.
- Each individual swimmer, or at most a buddy pair, may be accompanied by a rowboat with two people onboard, one skilled in controlling the boat and the



other trained in basic water rescue, equipped with a reaching device and flotation aid, continuously watching the swimmer(s).

- Alternatively, a closed circuit may be established where all swimmers are constantly in reach of safety personnel strategically positioned at fixed points on anchored boats, the shore, or piers. Each participant swims with a buddy, and the number and spacing of the swimmers in the water should not exceed the capacity of the watchers to easily count the swimmers as they move from one zone to another.
- Some competitive swimming events, such as triathlons, also cover long distances. Long-distance swimming races are not approved for Cub Scouts or Boy Scouts, but Venturers may participate in triathlon training and competitive events. All swimming activities conducted by Venturing crews must conform to Safe Swim Defense guidelines. Individual Venturers may participate in outside triathlon events sanctioned by USA Triathlon.

Guarded Public Facilities

Public swimming pools, water parks, and guarded swim beaches have excellent safety records. Units are encouraged to swim in regulated areas where the facility operator provides trained lifeguards. Safe Swim Defense application in such situations is less complicated since the unit is no longer solely responsible for area safety and emergency response. However, the unit leader is not relieved of all safety concerns.

Safety records at regulated facilities are good when lifeguards quickly recognize and respond to crisis situations. However, Safe Swim Defense guidelines generally mandate a higher standard for crisis **prevention**. The proven preventive strategies of Safe Swim Defense should be implemented to complement nominal facility procedures. That can be done without being obvious or obtrusive.

Even though many rescue situations arise from poor swimming ability or health conditions, few public facilities screen for either. Public facilities seldom have safeguards in place to prevent poor swimmers from attempting feats beyond their skill. Poor swimmers are seldom excluded from deep water, and water depths may not be well marked in natural bodies of water. When a BSA unit uses a guarded facility, the adult supervisor remains responsible for knowing the swimming ability of each unit member and pointing out areas of appropriate depth for those in



different skill classifications. The supervisor should then watch to see that such instructions are followed. Any special safety precautions indicated by a temporary or chronic medical condition must be observed.

The few drownings that do occur where trained lifeguards are on duty are often blamed on lack of timely recognition that someone is in trouble. The swimming area at a public facility may be scanned by only a single guard who is responsible for dozens of people. Ideally, guards are highly skilled and motivated and closely supervised. Rarely, a sole teenage lifeguard can become complacent or overwhelmed and may not perform as trained. A moment of distraction to deal with an unruly patron at a critical time is all it takes for a drowning person to slip unnoticed to the bottom.

Remote Swimming Area Setup

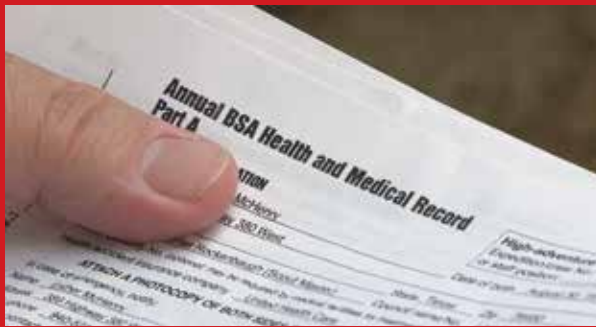

1. Prior to the setup, check health histories.



5. For large units, use a small group of older youth and clearly explain roles.



2. Determine swimming abilities.



6. Safe Swim Defense applies during setup, so assign buddies.



3. Ensure adequate rescue training.



7. Assign response personnel.



4. Assemble a safe swim kit.



8. Post a lookout prior to water entry.



9. Check shallow water with a line of swimmers wearing shoes.



13. After the site is checked for hazards, mark the area for the ability groups.



10. Sweep parallel to shore.



14. Use floating rope to enclose nonswimmer and beginner areas.



11. Use a single good swimmer to check deep water using feetfirst surface dives.



15. Boundary floats are sufficient for the swimmer area.



12. A safety line and safety swimmer may be used.



For more detail, view the remote area setup video listed on the Aquatics Resources webpage at www.scouting.org/outdoor-programs/aquatics/forms/.

To increase the margin of safety, Safe Swim Defense suggests a much larger guard-to-swimmer ratio than mandated by most state regulations. The unit leader need not assign unit personnel to act as guards to maintain the recommended ratio, but should act as a lookout wherever the unit swims, particularly if the facility is crowded. Additional surveillance is provided by the buddy system. Although it may be impractical to conduct buddy checks at a public facility, each member of the unit should still be assigned a buddy and given the responsibility to notify guard personnel immediately if their buddy needs help. At Cub Scouting events where parents participate with their children, parent and Cub Scout should be paired as buddies.

At the end of a session at a public facility, the unit leader is responsible for ensuring that everyone is accounted for. A time and a meeting place should be given to everyone at the start of the activity. Buddies should be told that they are responsible to make sure their partners are present on time. Generally, swim periods should not last more than an hour.

At guarded public facilities, the unit is still responsible for medical screening, ability groups, the buddy system, discipline, and supervision.

At large water parks where several activity features are spread over a large area, unit leaders should base supervision on age. Den leaders should accompany Cub Scouts from area to area, serve as lookouts, and assemble everyone before moving en masse to the next

feature. Although it may not be practical for the entire den to line up together for each activity, buddies should be in line together. Scoutmasters should ask patrol leaders to keep patrols together and to report together as a patrol at the end of the session. Venturers may proceed on their own from one activity to another so long as they remain with their buddies.

During major holidays, public swimming facilities and beaches near major urban areas can be extremely crowded. Units should avoid planning trips to such locations at those times.

Recap

Safe Swim Defense defines BSA policies on swimming activities. Those policies offer the conscientious unit leader effective risk-management tools based on known risk factors and effective preventive measures. Limitations on certain activities should not be viewed as stumbling blocks; rather, policies and guidelines are best described as stepping-stones toward safe and enjoyable adventures.

However, every possible contingency may not be covered with a hard-and-fast rule, and rules are poor substitutes for experience. A responsible adult leader, who understands his or her responsibility and the risk factors addressed by various policies, can exercise discretion regarding certain procedures while maintaining safety. Ultimately, each leader must personally decide if he or she is sufficiently experienced and well-informed to make the rational decisions expected of a **qualified** supervisor.





Basic Swimming Skills

An informed unit leader for an aquatics activity has several reasons for reviewing basic swimming skills, such as administering swim classification tests, helping with advancement, and as essential components for in-water rescues. While rescues of distraught swimmers can often be accomplished without entering the water, the ability to respond effectively to some drowning situations requires reasonable proficiency in basic swimming strokes such as the crawl, breaststroke, elementary backstroke, and sidestroke. The first two are used to approach a victim in the water; the second two to pull an unconscious victim to safety. Effective emergency response also requires knowing how to reach the bottom from the surface. The basic components of those skills are reviewed here. Additional information may be found in the *Swimming* merit badge pamphlet.

SIDE VIEW

FRONT VIEW

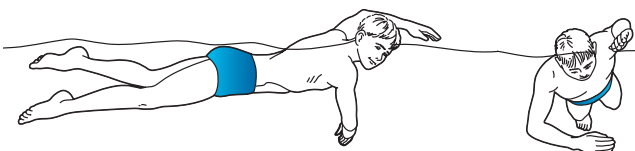
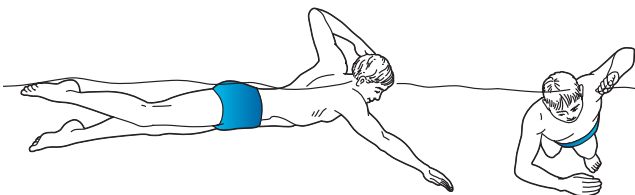
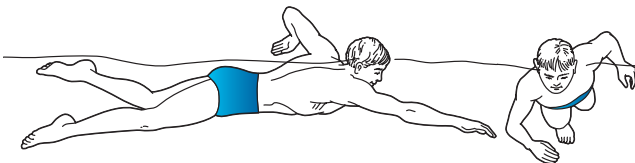
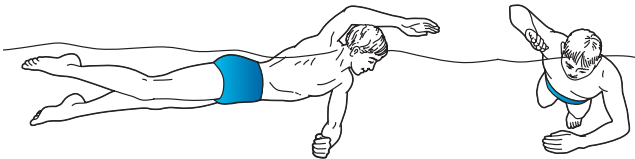
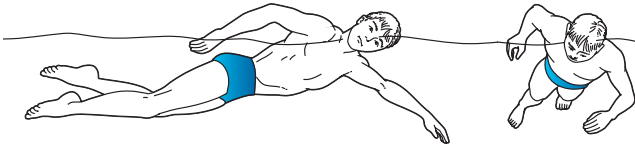
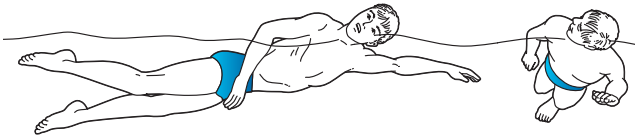

Crawl Stroke

The front crawl combines a relaxed flutter kick with a rotary arm motion and rhythmic breathing. It is the fastest stroke but can consume considerable energy. The stroke is most efficient if the head remains supported by the water. The body is rotated and the head turned to the side to inhale, and rotated down to exhale. Power is improved if the lower arm is bent and swept across the chest rather than rotated in a vertical arc. A slight glide is possible if the forward arm action is delayed slightly while the rear arm recovers in the air.

Most of the power comes from the arms, but the kick should also generate forward motion.

The crawl provides a fast approach during water rescue, and is often modified with the head up for that application. However, a head-up crawl with the head slung from side to side without rhythmic breathing is a sign of a poor swimmer (see picture below). Most people swimming in that manner lack the stamina to go far. A head-down version is preferred for the BSA swimmer test but is not required.





Breaststroke

The breaststroke is an easy, energy-conserving way to swim in a prone position. Coordination is a key to learning the stroke since the arms and legs do not provide power at the same time. The stroke begins with the arms and legs extended and the head in the water. The arms bend at the elbows and sweep down and back to shoulder level while pulling the body forward. At the same time, the head is lifted for a breath and the feet are drawn to the hips. The arms are then extended forward as the feet lead the knees in a circular motion that generates power and returns the legs to an extended position. To conserve energy, the body is allowed to glide in the prone position before beginning another stroke.

The racing version of the stroke omits the glide but is much less efficient. It takes a conditioned athlete to maintain a race pace for long distances, but even an out-of-shape casual swimmer should be able to swim long distances using the restful version.

The head may remain out of the water to provide a view during recreational swimming or a water-rescue approach.

The breaststroke is a good alternative to the front crawl for the BSA swimmer classification test.

SIDE VIEW

FRONT VIEW

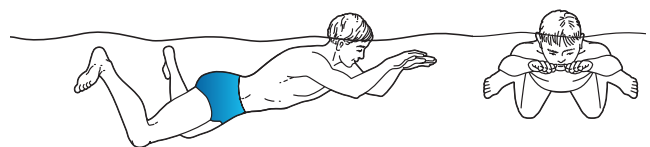
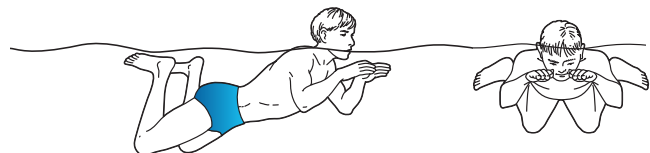
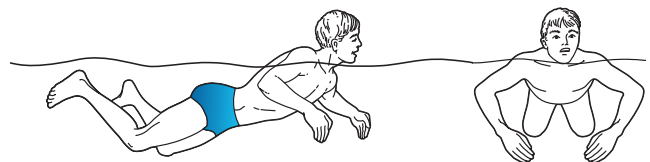
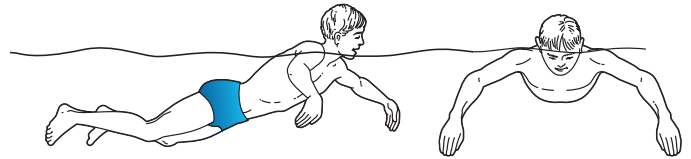
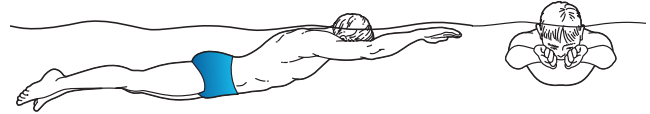

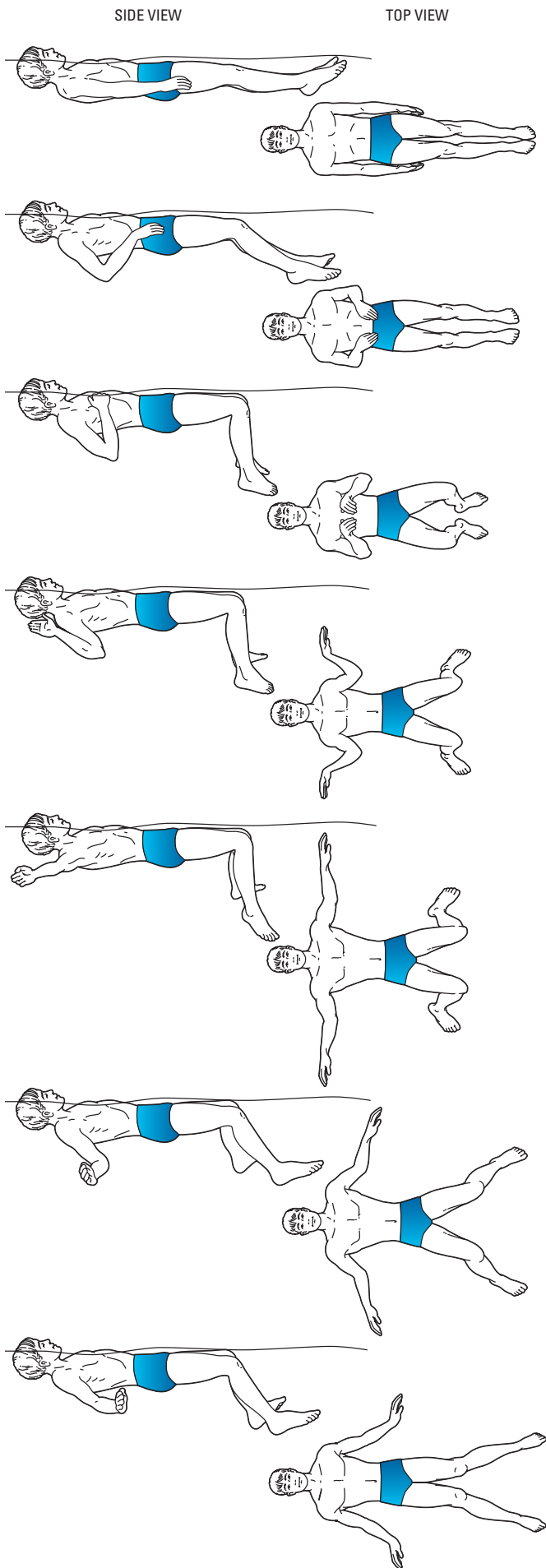

Elementary Backstroke

The elementary backstroke begins with the arms at the side and the legs together. The whip kick is started by slowly lowering the heels beneath the knees. The ankles are then rotated outward of the knees and returned to the start position in a rapid, continuous circular motion. The knees separate naturally.

At the same time the heels are lowered, the arms are brought slowly along the chest and extended outward at shoulder level. The hands and forearms push water toward the feet at the same time that the legs are making the circular "whipping" action.

The arms and the legs provide power at the same time and the body glides in the start position. A long glide is an essential element of the stroke when used to swim long distances.

The kick by itself is used in various water-rescue situations.

Raising the head and bending at the waist are common mistakes that distort the body position and make the stroke less efficient. Bending at the waist sometimes results from lifting the knees.

The elementary backstroke is the model of a restful backstroke for the BSA swimmer classification test.



Sidestroke

The sidestroke begins with the body on its side, with legs together, the lower arm extended, and the upper arm resting along the chest.

The sidestroke uses a scissors kick in which the heels are first tucked behind the body. The top leg is then extended forward and the bottom leg back. Power is generated when the legs are snapped back to a trailing position.

As the legs are tucked, the lower arm bends at the elbow and the hand and forearm pull the body through the water. The lower arm is extended forward as the legs complete the kick. Meanwhile, the upper hand is brought toward the chin and thrusts backward at the same time the legs are brought together.

The stroke uses a glide to conserve energy. Breathing is natural since the head remains out of the water. Progress is easily measured with a view to the side, but the forward view is restricted.

The upper arm can be used to grasp a flotation aid while the lower arm and legs are used to tow the device and a victim during a rescue.

Good swimmers can swim the stroke on either side but often find that the kick is inverted; that is, the top leg goes back rather than forward. That tendency can be overcome, but power is generated either way.

The sidestroke is a good alternative to the front crawl for the BSA swimmer classification test.

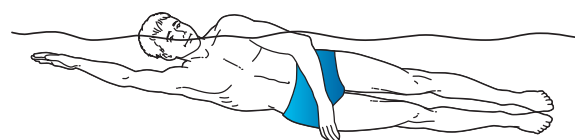
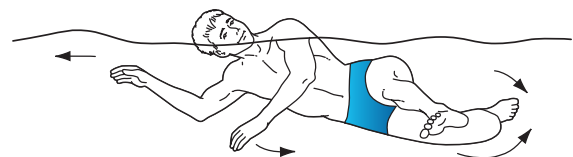
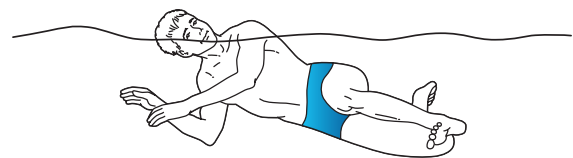
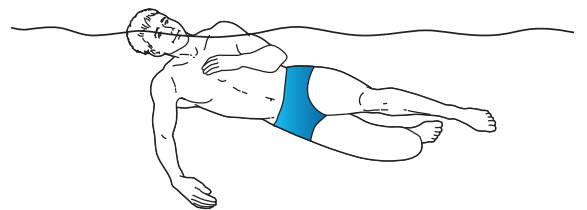
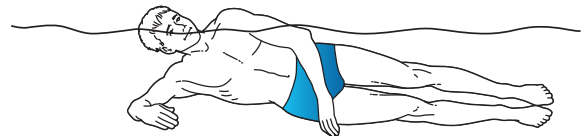
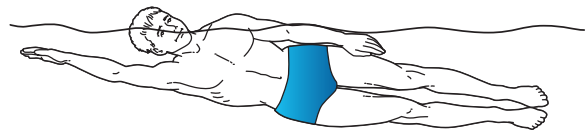



Feetfirst Surface Dive

The feetfirst surface dive allows a person treading water to descend vertically. A scissors kick is used to lift the chest clear of the water, at the same time the arms are pushed downward from an extended position. The legs are straightened below the water as the weight of the torso out of the water drives the body down. During the descent, the arms are lifted from the sides to provide additional downward force. The arms should not be lifted too quickly; they should push against the water rather than break the surface.

The feetfirst surface dive is used to check the depth when setting up a swimmers area and is the preferred method for retrieving a submerged victim in poor visibility.

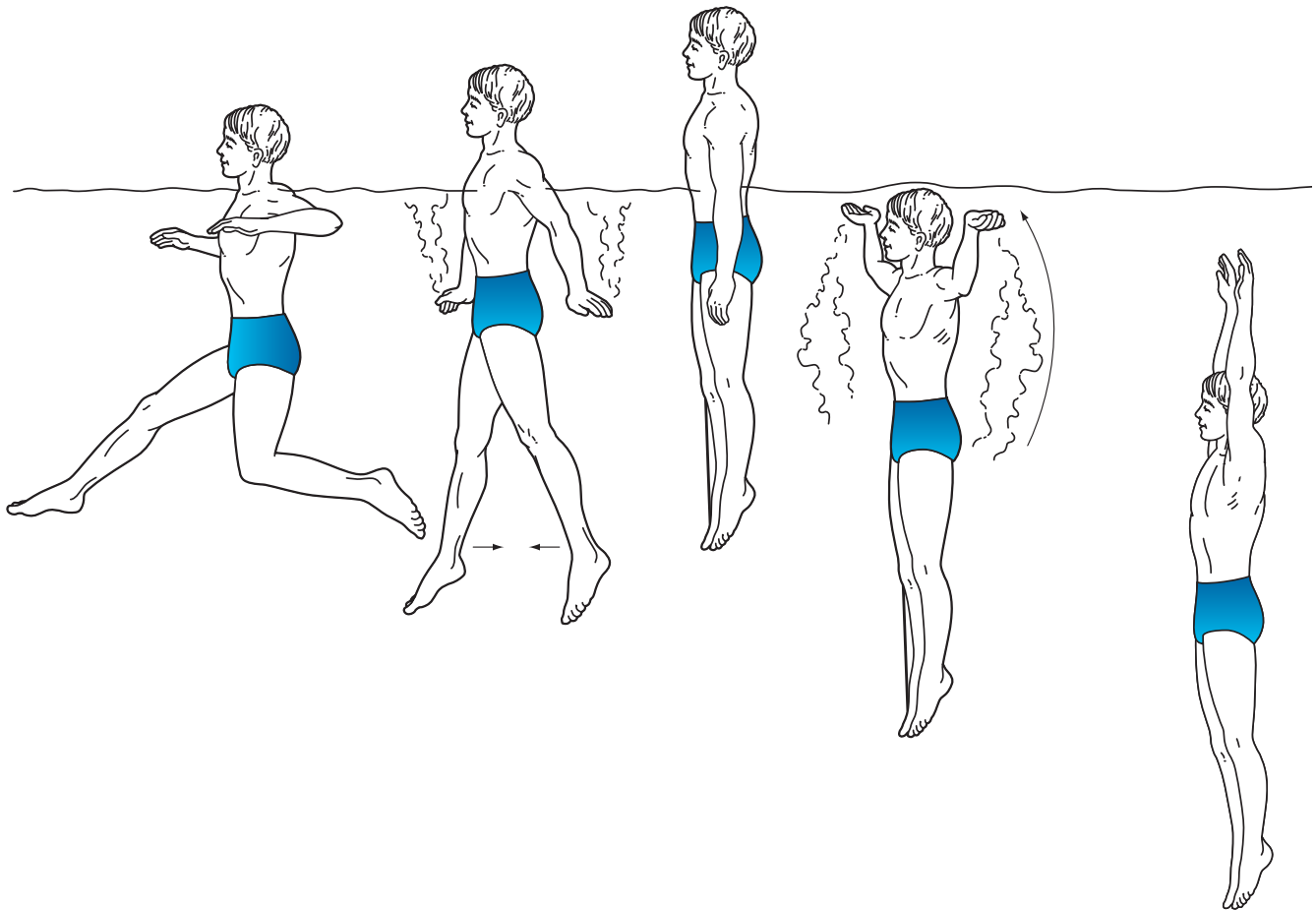



Headfirst Surface Dive

From a prone position, move forward with the arm pull of a breaststroke, and then scoop downward with the arms while bending at the waist and lifting the legs in the air. The weight of the legs above the water provides the force to descend. The headfirst surface dive is known as a **pike** if the legs are kept straight the entire time and as a **tuck** if the legs are first bent and then extended vertically. During the descent, the body should be in a streamlined position with the legs together and the arms extended in front of the head. An arm pull can be used to reach greater depths.

The headfirst surface dive is used to retrieve a submerged victim in clear water.

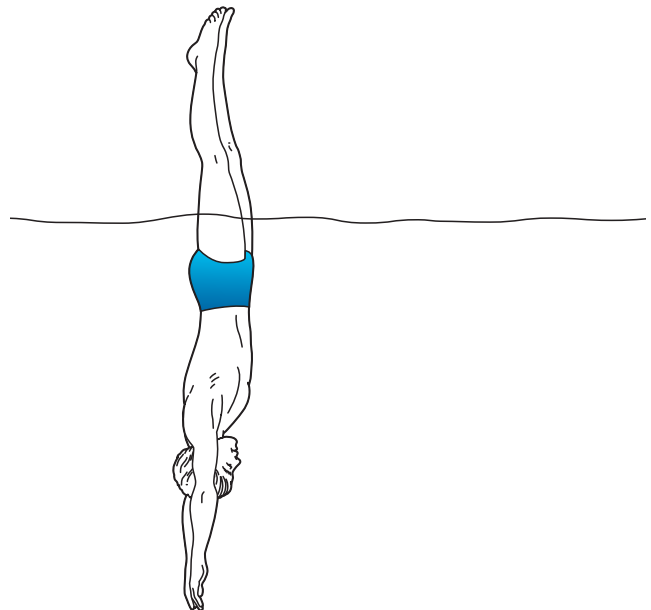
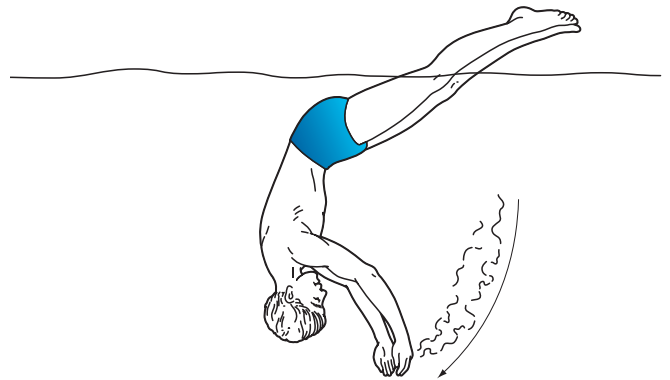
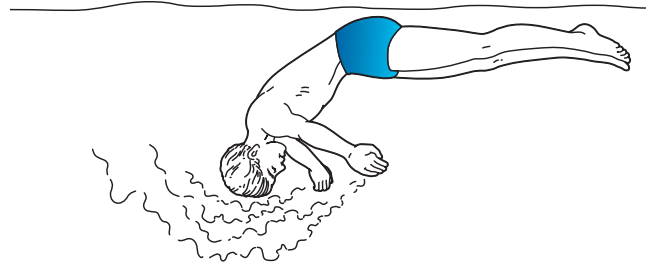
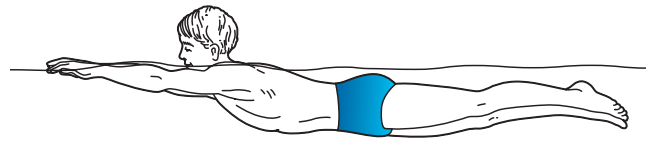

Nonswimmer Instruction

Safe Swim Defense is easier to administer if everyone in the unit is a good swimmer, as defined by the BSA swimmer classification test. Also, nonswimmers and beginners lack recreational and advancement opportunities until their swimming skills improve. Scouting strives to safely provide those opportunities to everyone.

One recognized means to improve swimming ability is to enroll a child in a small class taught by an experienced swimming instructor. A den is well served if the den leader can arrange swimming lessons for the group. Scouts attending summer camp are typically provided swimming instruction at all levels. For various reasons, such options are not always available on a timely basis. Unit leaders who are good swimmers experienced in dealing with youth can jump-start the process with a little guidance. Sometimes the best instructor is someone the child knows and trusts—e.g., a parent, working one-on-one—as opposed to a strange adult in the midst of equally unfamiliar, and perhaps insensitive, peers.

The following material outlines a step-by-step process to teach the skills required for a child to advance from nonswimmer to beginner. The same steps are applicable to just about everyone, regardless of age or comfort level in the water. However, both those factors will influence instructional details and how quickly the person will progress.

Attention spans and motivations for a 6-year-old are very different from those of a 16-year-old just learning to swim. The first benefits from games the second would find insulting. The first may expect to be held in the water, whereas the second may shy away from physical contact. However, the same progression of skills is essential to both.

Tiger age (that is, first grade) is an ideal time to begin stroke instruction. Many toddlers are introduced to the water at very young ages, but those programs familiarize the child with the water more than they teach skills sufficient for the youth to independently move safely and confidently in the water. It is one thing for a child to ride a tricycle in the yard; another for a child to ride a bicycle to school. The swimming instructor of a young child needs to emphasize safety at all times. A child who respects the water may be safer than one who enjoys the water without realizing the risks.



Ideally, a Tiger should be taught basic swimming skills along with a buddy of similar ability. That introduces the buddy system as a basic safety rule, and the companionship should make the learning process more pleasurable. On the other hand, a 16-year-old leery of the water may prefer to work with the instructor alone.

The time it takes to progress through the steps probably depends more on comfort level in the water than on age. Both the 6-year-old and the 16-year-old should progress rapidly if they are already comfortable in the water. The first few steps establish that comfort level, and in some cases may quickly be set aside. A few hours may be all it takes to improve enough to complete the beginner test. However, it may take a person who has learned to fear the water several hours to move away from the side and put his or her face in the water.

The initial stages should not be rushed. Learners should be encouraged to progress at their own pace according to their abilities, not those of someone else in a class. Any time a pupil is reluctant to try something new, the instructor should consider backing up a step. Patience is required to teach children to swim, particularly those apprehensive of the water.

A conscientious and understanding adult comfortable in the water can use the following steps to teach basic swimming skills. When introducing a new skill, the instructor should explain the procedure as simply as possible, demonstrate the skill, and then have the buddies try it, either one at a time or together as appropriate. At the start of any new period of instruction, participants should be asked to review the skills they learned during the previous session.

1. Orientation and Adjustment to Water

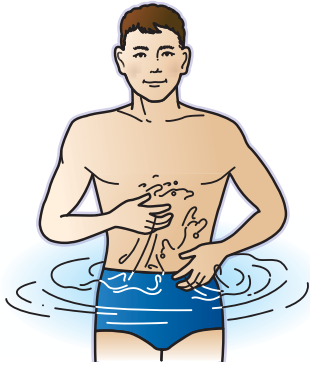

Although many nonswimmers will be ready to enter the water immediately to begin playing and learning, some will be timid or cautious, particularly on the first day or if the water is cool, turbid, or unfamiliar. For this reason and to minimize physical discomfort, the initial adjustment process should be gradual and deliberate. (After the first session, the adjustment routine may be quicker and more spontaneous.) The instructor should begin the first instructional period by entering shallow water and facing participants who are either seated on the pool's edge or standing on the beach at the water's edge a few feet from the instructor. With their buddies, participants should dangle their feet in the water where they can bend and reach water with their hands, or they should walk into the water down steps or on a beach until they are approximately knee-deep. (If the instructional area is not a pool, the nature of the bottom should be carefully explained before learners are asked to enter the water. A reassuring comment on turbid or discolored water also is important.) Imitating the instructor, the participants dip, splash, and rub water on their necks, faces, arms, and upper bodies. This exercise will let the instructor quickly identify those who are uneasy and will need special assistance in overcoming reluctance about the water. If all are willing and enthusiastic, this opening exercise to each lesson may be advanced quickly to a brief bob and splash.

2. Breathing

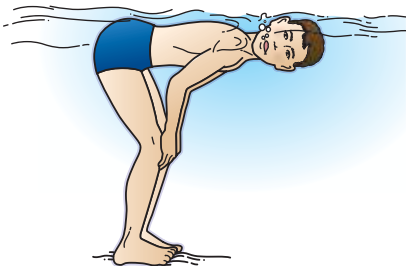

The most basic and important skill in swimming is breath control—when and how to inhale and exhale. Have the buddies wade waist-deep in the

water with the instructor. The instructor demonstrates cupping the hands, holding water to the face, and blowing into the water through the nose. Participants should imitate and practice. Next, have participants imitate the instructor as he or she bends forward at the waist with hands on knees, exhales through the mouth and nose toward the water, turns to the side, and inhales through the mouth. This rhythm is quickly learned, and the next step is to repeat with the face in the water while exhaling. After exhaling slowly through the mouth and nose for three to four seconds, the pupil rotates the head to one side until the mouth is clear of the water. With the mouth clear, the pupil takes a breath and rotates the face back into the water to exhale. Practice until the pupil can comfortably perform rhythmic breathing 10 to 15 times without hesitation. (In clear water, encourage participants to keep their eyes open. Even in muddy or turbid water, they should learn to open their eyes when inhaling to avoid disorientation.) One problem that could develop is that nonswimmers may want to raise their heads before turning to breathe. Demonstrate turning the head with the ear in the water, then the nose in the water. (Help the participants practice

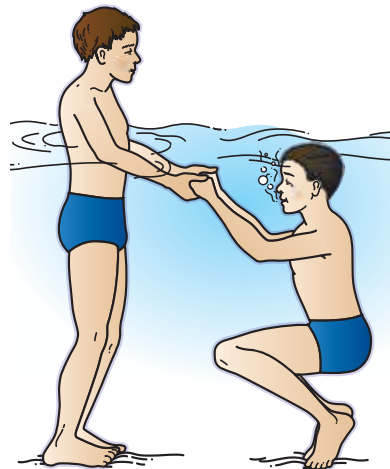

by reminding them: ear-nose . . . ear-nose . . . ear-nose.) Be sure they blow air out through the nostrils when exhaling in the water; this keeps water out of the nose.

Next, have buddies practice the see-saw in chest-deep water. To do this, have them join hands and face each other. One buddy takes a breath, goes below the surface, and remains there for two to three seconds while the other buddy remains above the surface. As the first buddy exhales and comes up, the other goes down for two to three seconds. This continues in a rhythmic pattern. Keep the participants working on this until able to do it 15 to 20 times without stopping.

3. Body Position and Buoyancy



Some nonswimmers may be reluctant to try floating or other skills because they do not know how to recover their footing. First,

demonstrate how to bob. Have the pupils stand in chest-deep water with their forearms lying on the surface. Have them feel the upward thrust caused by pushing their arms down. Next, have them push down while lifting their feet from the bottom. To recover, they simply straighten their legs. Repeat with faces in the water between extended arms. To recover, they push down with their arms, lift their head, and straighten their legs. Once both buddies are comfortable lifting their feet from the bottom, they are ready to learn buoyancy using the barrel or jellyfish float.

Demonstrate floating by taking a deep breath, leaning forward, and holding the knees against the chest with the face down in the water. The instructor can also demonstrate the importance of breath control in floating by beginning a barrel float, then slowly exhaling and sinking while staying in the floating position. While practicing the barrel float, participants also have an opportunity to practice their recovery to a standing position. After they have practiced the barrel float and discovered their own buoyancy, they are ready to begin learning the basic swimming stroke components and coordination.



4. Prone Float and Glide

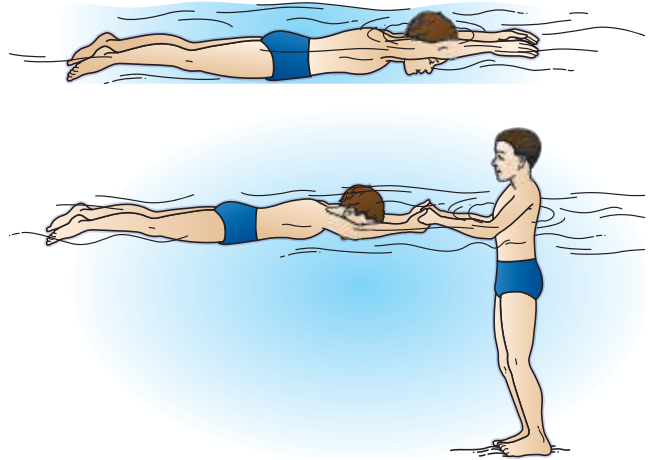

The prone float may be learned either holding to the side of a pool at arm's length or holding the hands of a buddy standing in waist-deep water. An assistant instructor is handy to demonstrate the buddy assist if that method is used.

Buddies face each other in waist-deep water while holding hands at arm's length. One buddy takes a deep breath, puts his or her face in the water, and then eases the legs back and straight behind until the body is extended and relaxed. After a few seconds in this position, the hands are released and the floater recovers his or her footing by pulling the knees forward, pressing the hands down, and lifting the head. (The recovery should be slow and easy.) The instructor should help each participant personally with the first attempt if there is any reluctance. Practice until both buddies are comfortable holding the float for several seconds.



The next step is to demonstrate and practice plunging and coasting (the prone glide). This skill is nothing more than a moving prone float. The instructor should first demonstrate the

skill, including a proper recovery to the standing position. In waist-deep water, have the participants squat slightly and lean forward with arms extended and hands together until the shoulders are below the surface. Then have them take a breath, place their faces in the water, and push forward off the bottom. (Be sure to have participants push

toward or across shallow water, never toward deep water.) For the reluctant participant, the instructor should hold his or her hands and walk quickly backward for several repetitions until he or she becomes familiar with the movement. Practice until each buddy can glide comfortably for over a body length.

5. Back Float and Glide

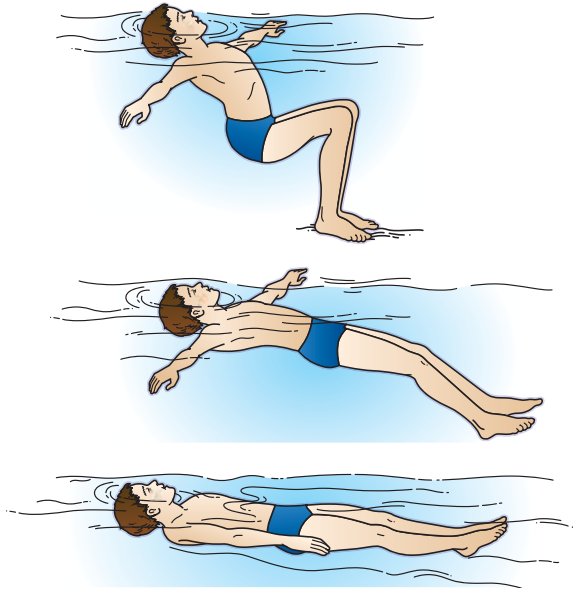

The instructor demonstrates the back float in waist-deep water by squatting down as if to sit on a chair. When the shoulders are just below the surface, the instructor extends the arms to the side just below the surface with the palms up. Next, the instructor takes a deep breath and tilts the head well back with the chin up and the ears in the water. The legs are slowly extended and relaxed as the body bobs and settles into a natural floating position with the arms extended above the head with palms up on the water. (Some will float high on the water with hips and legs near the surface; others will float with only their face and portions of their chests breaking the surface.) As with the prone float, the back float demonstration should include an easy recovery to the standing position.

As participants make their first attempts to float on their backs, the instructor or assistant should provide some support under their backs and hips, not lifting but simply balancing the body at the buoyant level. Physical contact is important in this exercise to overcome natural insecurity about falling backward in the water. Once the participant has relaxed and is floating, the support is withdrawn. This withdrawal should not be sudden or unanticipated, however.

When the participants have learned the back float, they can be taught a back glide. Have them squat down and lean back with arms out, as if beginning the back float, and then push off gently with the feet as the arms are swept down to the sides with palms in. This skill should be demonstrated with an easy recovery at the end of the glide. Watch the position of the participant's head. If it is too far back, water may wash over the face. A raised head will cause the body to sink.

6. Flutter Kick

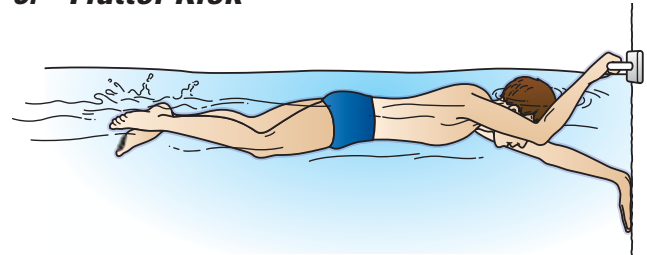

Demonstrate the flutter kick in a prone position while holding onto the side of the pool or supported by a buddy. Keep the toes slightly pointed, the ankles and knees relaxed but straight, and kick from the hips. Kick slowly and fluidly. Buddies can practice at the edge of the pool (a ladder may provide a good anchor if the pool edge is difficult to grasp) or while being towed slowly by the instructor wading backward. Kickboards are also useful.

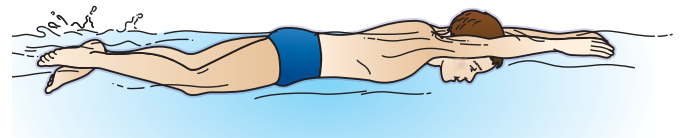

Once the participants learn the general motion, the best way to practice is with the prone glide. Have them begin their glide and then add the flutter kick. Challenge each buddy to go farther than the time before. Emphasize rhythm and distance, not speed. Some participants chop when they kick, bending the leg at the knee. Others will kick on the top of the water. Stress kicking from the hip with the legs underwater.



7. Arm Movement



The arm pull is first demonstrated and practiced alone and then added to the prone glide. To practice the basic skill, have the participant stand in chest-deep water and bend forward slightly, practicing the arm movement slowly and accurately without losing balance. Start with one arm extended and the other along the thigh. The extended arm is pulled backward near the centerline of the body, then bent at the elbow as the hand clears the water and swings forward again. The other arm moves similarly, but in opposition. The hand enters first, in front of the shoulder. The palm of the hand may be slightly cupped but should be relaxed and comfortable. The power of the stroke comes from pressing backward with the forearm as well as the hand.

After getting the feel of the stroke while standing, participants should continue to refine the motion while walking forward. Next add the arm stroke to a prone glide, without a kick, with pupils stopping when out of breath. Practice until four or five arm rotations can be done easily.

Next demonstrate breathing to one side while doing the arm stroke. Let the buddies choose whichever side they want. The head is turned to the side with the ear in the water, as in step 2, as the arm on that side is pulled beyond the head. All of the individual elements of the front crawl are now in place.

8. Coordination

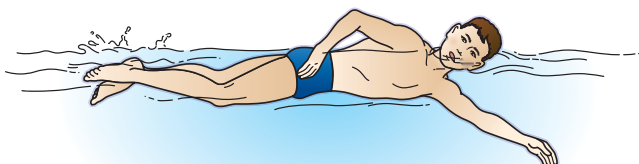

Demonstrate the complete stroke, and then let the buddies work on coordination, which is gained only with practice. Start with a prone glide with a kick and then add the arm motion. It may be necessary to back up to refine individual elements until the components work well together. Don't rush this step but provide enthusiastic encouragement tempered by patience. The instructor should stress the ease of the stroke, not speed. The combined motion should be easy, relaxed, and streamlined.

Concentrate first on form, and then practice for longer distances. The next two steps can be introduced at this stage, but continue to work on coordination and distance in shallow water until the buddies can easily swim at least 25 feet without stopping.

9. Turning Over

Once participants have learned the crawl stroke and are able to do a back float and back glide, they should learn how to turn over from front to back and from back to front. This is a useful safety skill, enabling a swimmer to rest on his or her back when they begin to tire, and then to resume the crawl stroke when rested.

To turn from the crawl stroke position onto the back, the swimmer lowers one shoulder and turns the head in the opposite direction. To turn over while swimming on the back, the swimmer lowers one shoulder and turns the head in the same direction. Although explanation and demonstration of these turnover maneuvers will be helpful, participants will learn quickest by practicing and experimenting with the concepts of "roll over and float" and "roll over and swim." Despite the apparent simplicity of this specific instruction, the instructor should not omit it, and participants should practice these maneuvers in shallow water before attempting to swim in water over the head in depth.

10. Turns, Reverses, Stops, and Starts

Some skills are not particularly significant when swimming in shallow water where footing is always available. But the ability to stop and restart swimming, to reverse direction, and to turn while swimming is of critical importance when swimming in deep water. (Recall that the beginner classification test requires a stop and sharp turn.) To stop while swimming the crawl stroke, the swimmer simply stops kicking and raises their head while pushing down and slightly forward with the arms. A reverse after stopping can be done in one quick motion by sweeping both arms in the same direction across the front of the body while turning the head and shoulders in the opposite direction. Starting a stroke in deep water is accomplished by pressing the arms down from the surface of the water and back alongside the body while leaning forward, putting the face in the water, and beginning the flutter kick. This planes the body into the prone glide position for the crawl stroke to begin. To turn while swimming the crawl, the swimmer sweeps wide with the arm stroke on the side opposite the turn and reaches out in the direction of the turn with the other arm.

Practice all of these skills in chest-deep water until the pupils are proficient. The buddies may then be gradually introduced to water over the head. For example, in a small uncrowded pool, they may start in shallow water, swim to the deep end, stop by holding the side, and then return to standing depth. Later, they can turn rather than stop. (A reach pole is an excellent safety device to have on hand once the buddies are ready to venture into deep water. It should be positioned where easily accessible, but unobtrusive.)

11. Jump Entry Into Deep Water



An important part of learning to swim is mastering the skills involved in deepwater entries. To teach a simple jump entry, have the participant stand at the pool or dock edge where the water will be chest-deep. The pupil should bend slightly at the knees and hop forward as if trying to land with both feet together on the surface of the water. Arms should be extended forward with the body leaning slightly forward from the waist. Once the buddies are comfortable with the jump, move to shoulder-deep water and have the pupils lean forward and begin swimming as they come up. The participants should jump away from the side, rather than try to land close enough to grab hold. Progress to slightly deeper water until the participant is ready for the initial jump into water over the head.

By this stage, the buddies should have practiced swimming over short sections of deep water. However, they may still be apprehensive about their first jump into deep water. If they haven't done so before, let the buddies slip into the deep end one at a time, hold to the side, take a breath, and submerge. Then repeat without holding the side. If they are not comfortable letting their head go under water in the deep end, they are not ready for a jump from the side into deep water.

Stroke Refinement

While an excellent milestone, the ability to complete the BSA beginner classification test is just the first step to becoming safe, comfortable, and proficient in the water. Anyone working toward or beyond the beginner level will benefit from frequent opportunities to practice their skills. For all ages, learning though recreation is more enjoyable than mechanical repetition. Nonswimmers and beginners will progress simply by being allowed to play in the water (under safe supervision, of course). However, advancement to the swimmer level and beyond is most easily accomplished through instruction by an experienced instructor. The American Red Cross, the YMCA, and various parks and recreation departments offer professional instruction for all levels and age groups. The BSA local council aquatics committee will be able to assist unit leaders with contacting volunteers in those organizations. Boy Scouts can increase their skills by working on First Class rank and Swimming merit badge requirements at summer camp, during special district winter aquatics programs, or by contacting a counselor through their Scoutmaster.

BSA swimming programs emphasize early mastery of restful strokes. A person with a restful elementary backstroke should be able to swim for long distances in warm water, even in less-than-perfect form. However, a person whose only option is a poorly executed crawl will need to be a well-conditioned athlete to cover anywhere near the same distance. A restful backstroke or breaststroke with a glide doesn't take much energy, and uses the legs for much of the power. A hasty crawl, particularly with the head slung from side to side, takes a lot of energy, and much of the effort comes from the arms. The difference is similar to that between walking and running. Most people can walk for long distances on flat ground without breathing heavily and having to stop to rest. Those same people will not be able to run full-out for long. Running, and swimming the crawl, simply takes more energy, and most folks aren't trained marathon runners or competitive swimmers.

The learn-to-swim programs of several organizations place an early emphasis on competitive strokes and teach those before restful strokes. Anyone completing their full course progressions will emerge an excellent swimmer proficient in all the basic skills. Unfortunately, while many parents enroll their children yearly in the first few levels, fewer and fewer continue to the higher levels where the

restful strokes are mastered. Instruction should continue until basic strokes such as the elementary backstroke, the breaststroke, and the sidestroke are learned sufficiently that distances are easily measured in hundreds of yards, rather than a few tens of feet. Surveys reported by the U.S. Centers for Disease Control suggest that a large percentage of Americans fall far short of that goal.





Water Rescue

The goal of Safe Swim Defense is to eliminate the need for water rescue. Even so, the adult supervisor must ensure that appropriate emergency response will be implemented, should the need arise. Efficient and safe water rescue requires properly equipped and trained personnel.

If the adult supervisor lacks a water-safety background, an easy way to provide adequate protection is to conduct unit swimming only where trained lifeguards are provided by a facility or tour operator. Although that is certainly a reasonable and prudent approach, it limits the opportunities available to the unit. The alternative is for unit leaders to acquire the necessary knowledge for the unit to function safely using its own resources. Many do. Required training in Safe Swim Defense only allows unit leaders to gauge their level of preparation; it seldom provides much physical training in the necessary skills. BSA Aquatics Supervision: Swimming and Water Rescue covers the skills presented in this section and is recommended for leaders conducting swimming activities where trained lifeguards are not on duty.

Those who have completed BSA Lifeguard training are also ideally suited to assist with safe unit swims. Unit members who have completed lifeguard training from organizations such as the American Red Cross, the United States Lifesaving Association, and the YMCA are also valuable resources, but they should still receive Safe Swim Defense training. Such organizations assume that the lifeguards they train will be employed at an established facility. They may not include instruction in how to establish a temporary safe swim area, how to perform rescues with a range of equipment, or how to limit risk using ability groups and the buddy system. Safe Swim Defense addresses those gaps.

BSA Lifeguard and lifeguard training programs offered by other organizations are designed to meet regulatory demands for paid, professional lifeguards. BSA employees who supervise swimming activities at Scout summer camps are subject to such standards. Although the material in this section is consistent with the training received by professional lifeguards, it does not constitute a complete lifeguard training program. Training for BSA Swimming and Water Rescue is designed to prepare the volunteer unit leader to conduct safe unit swims in situations where all elements of Safe Swim Defense are in place, not to serve as a professional lifeguard in other situations.

Victim Recognition

The first step in a rescue is recognizing that someone needs help. The need may be obvious. You may observe someone dive into shallow water and then float facedown motionless at the surface. But not all drowning situations are that dramatic or easy to spot. A child who appears to be playing may actually be in serious trouble.

It is important to note that not everyone in difficulty will call for help or seem to be struggling.

People in danger of drowning can be divided into different classes or categories based on their condition. In turn, basic rescue techniques are influenced by those conditions. Different classification schemes are possible, including *distressed* versus *drowning*, *conscious* versus *unconscious*, *active* versus *passive*. The labels are less important than identifying specific behaviors and their effects on rescue technique. Several such categories are discussed below. Note that these are guidelines, not absolutes. An actual victim might not exactly fit the descriptions and may slide from one type into another over the course of a rescue. In crowded, murky water it may be difficult to tell one type from another. Basically, you need to identify anyone unable to control their own movements in the water and decide whether to respond by providing a support device or performing a contact rescue. The time you have in which to respond will also depend on victim characteristics.



Surveillance Signals and Response

Good Swimmer	Poor Swimmer	Misbehaving Swimmer	Distressed Swimmer	Active Drowning Victim	Passive Drowning Victim
Confident, relaxed motion while swimming or treading water. Decent stroke mechanics.	Weak, erratic strokes over short distances. Lacks rhythmic breathing. Difficulty changing direction or treading water.	Running, shoving, ducking, jumping near or on others, diving into shallow water.	Struggling to stay afloat or make it to the side. Able to breathe, but unable to level off. Hair in face. Anxious. May call for help.	Vertical. Head back, struggling for breath. Ineffective up and down movement of arms. Cannot call for help.	Face down, not breathing, at or below surface of the water. No movement.
Continue to monitor.	Continue to monitor. Return anyone out of their depth to proper area.	Quickly, firmly, and fairly correct all rule infractions.	Provide immediate assistance.	Provide immediate assistance.	Provide immediate assistance and simultaneously summon EMS.

Tired Swimmer

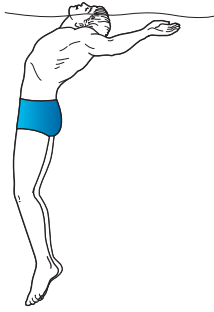

A tired swimmer may ask for help. He or she might be swimming ineffectually in short bursts, proceeding slowly with a weak stroke, clinging to a boundary line, or trying to float on their back. They lack, or think they lack, the energy to make it to shore and probably

only need encouragement and a helping hand. Such a situation may arise during a swim classification test when a weak swimmer becomes fatigued. A tired swimmer is calm, should reply to questions, and should cooperate with the assist. Because the tired swimmer is not at immediate risk of submersion, the rescuer may deliberate momentarily to choose between direct assistance and simple encouragement.



Distressed Swimmer

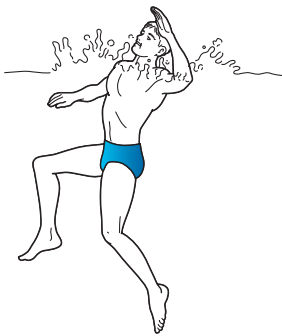

A swimmer in distress is normally vertical in the water and exhibits various degrees of anxiety or panic. He or she may be a poor swimmer who has exceeded his or her capabilities. A poor swimmer caught in a rip current may first become exhausted

swimming against the current, and then become frightened. Acute medical problems such as a cramp or a stroke may also incapacitate a conscious swimmer and necessitate a rescue. By definition, the distressed swimmer is no longer making any progress but is still able to struggle enough to keep their head out of the water. The swimmer may call or wave for help. If they were able to level off and apply the same energy to their swimming effort, they might be able to reach safety on their own. The swimmer may act on clear instructions from a res-



cuer and reach for equipment as it is presented. However, such a victim may not be rational and could grab a rescuer. Contact should be avoided. The longer a distressed swimmer remains in trouble, the more likely it is that they will submerge. Prompt support is needed.

Active Drowning Victim

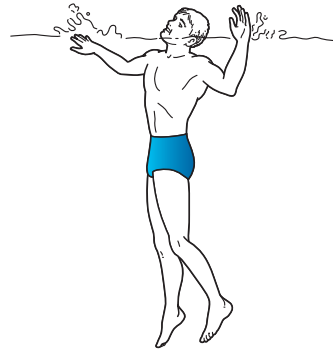

An actively drowning person is also distressed or distraught. An intentional attempt to remain at the surface — not mental state — is the distinguishing characteristic between a “distressed swimmer” and

an “active drowning victim.” The second term is used to indicate a conscious person with no deliberate control of motion. Such a victim lacks the ability to remain at the surface and will generally submerge in less than a minute. They are unable to call or wave for help and must be recognized by their facial expression and inadequate movement. The victim usually is vertical in the water and may have their head thrown back with face upward. Arms are extended to the side pressing down or flapping. There is no effective leg movement. The head may bob below the surface. This is known as the classic or instinctive drowning response, and may resemble someone playing in the water. Although conscious and very aware of their situation, such victims cannot respond to commands or reach for nearby equipment. However, such victims may grasp an object, such as a flotation aid or an unwary rescuer, that makes sufficient contact.



Unaided, a poor swimmer in distress may progress to the actively drowning stage. Other victims may immediately show such behavior. This is particularly true of nonswimmers who have never supported themselves in deep water. A nonswimmer stepping off a submerged ledge will be unable to move a few feet to shallow water. A young nonswimmer knocked off an air mattress will be unable to reach for it and may submerge in only 20 seconds. Speed in rescue is essential. (Such possibilities reinforce the need for identifying nonswimmers, providing close supervision to limit their activities to shallow water, and teaching them simple swimming skills.)

Unconscious Victim

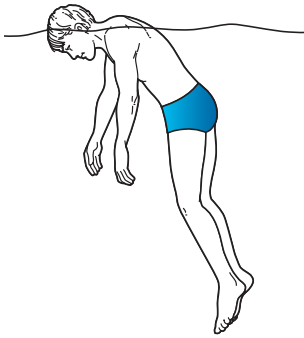

People can lose consciousness in the water from a variety of causes. Unaided, the active drowning victim will soon lose consciousness and become a passive drowning victim. Immersion in cold water can result in progressive loss of ability.

That will slowly lead to unconsciousness even if the person is wearing a flotation device. Other swimmers may become unconscious with little or no warning as a result of a diving injury, heart attack, stroke, seizure, drunkenness, or drug reaction.

An unconscious victim may float facedown at the surface or, more often, sink partway, or all of the way, to the bottom. Speed in rescue is critical, both in making contact and also while moving the person to safety. Breathing will stop and must be restarted as soon as possible if the victim is to survive. Because an unconscious victim cannot grasp a rescue aid, some type of physical contact will be required during a rescue. A person who has lost consciousness in the water will always need medical evaluation. EMS should be summoned at the same time the rescue effort is started.



Injured Victim

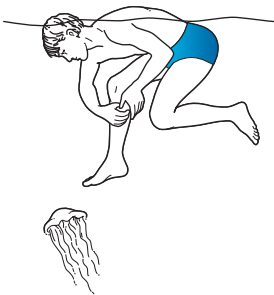

A water rescue can become even more complex if the victim is injured. Diving into shallow water or being struck by surfboards can cause head and spinal injuries. Cuts and broken bones can result from boat collisions, water-skiers hitting objects, cars entering

the water, boats capsizing in rapids, or a swimmer being cast against pilings by the surf. Burns can occur from gasoline explosions on motorboats. Fishermen might be

entangled in hooks. Painful stings may result from encounters with marine life. In all such situations, general first aid rules apply: Treat the most serious condition first, do no further harm, and quickly summon advanced help if needed. In water rescues, the most serious condition is likely to be lack of breathing. However, standard rescue techniques for a person who is not breathing may worsen a spinal injury.

A safe swimming area, combined with supervision and discipline, should preclude injuries during unit swims. Nevertheless, a headfirst dive into shallow water takes only a brief lapse in judgment. The unit leader should be aware of ways to stabilize a victim of neck or spinal injury until EMS arrives.



Endangered Swimmer



The above classifications are based on a victim's lack or loss of swimming ability. One more category is needed to address situations when a competent swimmer faces serious difficulties. A capsized canoeist caught in a cold, fast current is one such situation. A kayaker

pinned against a rock is another. Ocean currents can sweep a swimmer out to sea. Fast-rising tides against a cliff face can catch a hiker off guard. Fishermen can be swept off jetties by abnormally high waves. Flash floods can trap motorists in their cars. The situations can vary greatly and so will rescue responses. In some cases, the victim can make it to shore without aid and the rescuer's job becomes one of follow-up support, first aid, and transportation. In others, assistance can be provided from shore. In still others, the only safe option is to immediately seek aid from a trained rescue squad with special gear. (This category is included for completeness: it should not be a concern at a safe unit swim site.) Techniques for assisting capsized boaters will be discussed under the headings for various craft in the next section.



Rescue Techniques

Safe, effective rescue of a person from the water is easier with prior training and appropriate equipment aids. At a unit swim, the adult supervisor is responsible for ensuring that adequate rescue equipment is available, and that assigned rescue personnel know how to use it. Preparation needs to include three types of victims: conscious victims who will grasp a rescue device, unconscious or nonresponsive victims who cannot, and victims of spinal injury whose movements must be minimized.

For conscious victims, effective rescue response means finding the easiest way to provide them with support. Victims can be handed a rescue aid from the side, thrown a rescue aid, or have a rescue aid taken to them by boat or swimmer. **Reach, throw, row, go** is the mnemonic for those options. Reaching assists from poolside, dock, or boat are normally the easiest, followed by throwing assists. If neither of those techniques is viable, then a swimmer can push a float or carry a line to the victim. Contact with a conscious, active victim is seldom necessary. However, recall that those displaying the classic drowning response will not be able to reach for an object that is placed nearby; the equipment aid, but not the rescuer, must be placed in contact with the victim.

An unconscious victim, or someone suffering a seizure or other incapacitating medical condition, will not be able to grasp a rescue device. Contact rescues, which may be nothing more than grasping the victim from the side of a pool, cannot be eliminated. Several techniques, with and without equipment, are available to move an unconscious victim to safety and will be discussed in the following material. Rescuer-to-victim contact is also necessary to aid someone with a spinal injury.

All rescues end with removing the victim from the water and providing appropriate aftercare. Details again depend on whether the victim is conscious and responsive, nonresponsive or unconscious, or has a suspected spinal injury.

The safety of the rescuer is a major factor in all emergency situations, including a potential drowning. Water rescues in certain “lifesaving” situations are inherently dangerous, such as those encountered by swift-water rescue teams or Coast Guard rescue swimmers. In a *lifesaving* situation, a rescuer may face an unsafe area with only makeshift equipment and no assistance from others trained in water safety. The appropriate response in such situations may

be to go for help. In a *lifeguarding* situation, the area is safe and well-known, appropriate equipment is at hand, and trained backup is available. Some people do drown in futile attempts to save others in “safe” locations such as pools, but the would-be rescuers are usually frantic friends or relatives with no training whose swimming skills are little better than those of the person in distress. Such double drownings demonstrate that the potential risk of approaching a struggling victim is not to be taken lightly. However, in the controlled environment that should exist at a unit swim, there is little risk to a rescuer who follows the procedures described here. Contact with an active victim is avoided by using flotation aids or other devices. Although contact may be needed with a victim who is unable to grasp a rescue device, such a victim is also unlikely to grasp a rescuer.

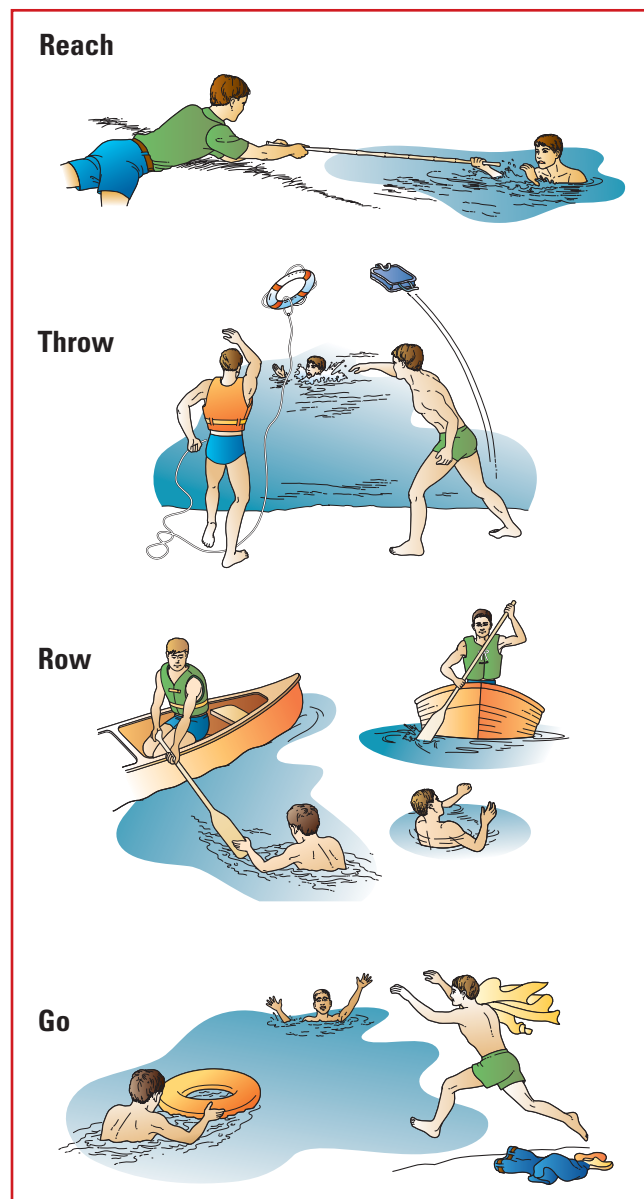

Reaching Rescues

Reaching rescues are safe, simple, and effective. They can be used for all types of victims. Many drownings occur close to safety. That's because the poor swimmer often gets into trouble as soon as they enter water over the head. That is likely to be close to the edge of a pool or dock. A rescuer at such a location simply needs to lie down, extend a hand, and pull the victim to the side.

If the victim is farther out, a reach pole can be used. A distressed swimmer will probably reach for the pole, but an active drowning victim will not. For both types of victims, make sure the pole comes into direct contact with their hands and arms. Sweep the pole under their arm from the side rather than poking at them straight on. In this, and all rescues for an active victim, tell the victim clearly what you are doing and what you wish them to do. Keep your weight low with one leg behind the other and brace yourself by putting your weight on the back leg.

If a conscious victim grabs an extended hand or pole, they often will stop their own efforts to remain afloat. That sudden extra weight can topple the unprepared rescuer into the water. That is the reason for lying down or otherwise bracing yourself. Don't stand with your feet on the edge and bend over to extend a hand or pole.

Unconscious victims will not be able to grasp a pole or other device. You can still use a reaching rescue if you can reach far enough with your own hand to grab them. You can also use a special device, called a shepherd's crook, which may be available at hotel or other semiprivate pools. The shepherd's crook is a pole with a large loop on one end. The loop is used to snag an unconscious victim below the shoulders and draw them to shore. Do not use this technique if you suspect that the person is unconscious because he or she dove into shallow water and injured their spine.

The simplest reaching rescues are performed without entering the water. In other cases, your reach can only be extended far enough by going partway toward the victim. In deep water, you should firmly grab a rigid object, such as the edge of a dock or a pool ladder. In shallow water, you may be able to wade directly to a small child who can't touch bottom or to an unconscious person who hit their head on the bottom. In a unit safe swim area, you should know the range of depths for which a wading rescue is appropriate. In lifesaving situations, always be extremely careful about wading in shallow water toward someone your own size who is struggling to stay up. The victim has probably stepped off a ledge into deep water. It's appropriate to extend a pole to such a person if you have a firm footing on the bottom.

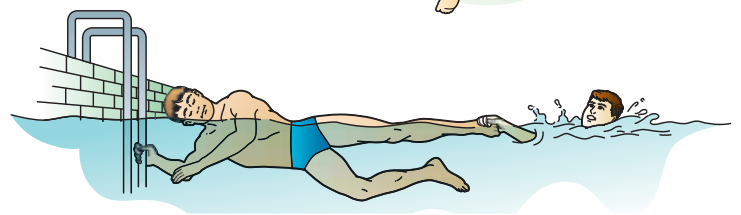
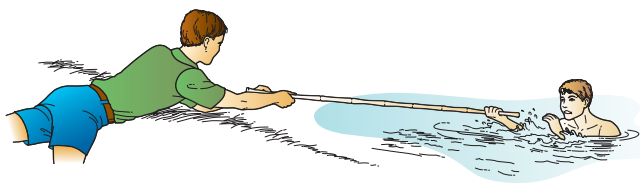
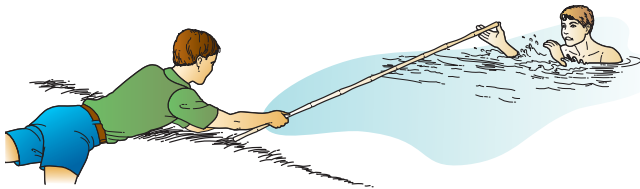

Throwing Rescues

If a victim is beyond reach of a hand or pole, a throwing device may be used. A float with a line attached is best since the float provides support and the line allows you to pull the victim in. But either a float or a rope can be used alone. Although they can be used for some active victims, throwing assists are not appropriate for unconscious subjects. Also it may be difficult to place a line such that an active drowning victim can grasp it. **Therefore, unit swim protection cannot rely solely on throwing devices.** Throwing rescues are not needed much around pools, particularly small private ones, because reach poles alone can provide adequate coverage. A ring buoy with a line is handy at a lake with rescue personnel stationed on a pier or floating platform. A throw bag is a primary rescue device for river float trips.

An unweighted rope, or **heaving line**, should be coiled before a toss. Tie a small bowline loop in one end and place the loop on your wrist so you won't accidentally toss the entire line into the water. The loop should be loose enough that you can easily slip your hand free if needed. To coil the line for a right-handed throw, place your left hand on your left knee and stretch the line to the full reach of your right hand. Then return the line from your right hand to your left hand to form the first coil. If you leave your left hand fixed to your knee and reach as far as possible each time with your right hand, all of the coils will be the same size and less likely to tangle when thrown. Reverse the directions for a left-handed toss. This technique is better than wrapping short coils on your forearm or moving both hands apart and then together.

When approximately half of the line is coiled, gather the loops with the index finger of the hand holding the coils, and coil the rest of the line on your remaining fingers. This will allow you to separate the rope into two coils, one from which the line feeds and one that is thrown. You need the weight of the second coil to make an accurate toss.

With one coil in each hand, step back with the leg on your throwing side, swing back the arm with the free coil, and throw the coil underhand to the victim. Release the coil when your throwing arm is about level and still moving. If you release too soon, the rope will land just in front of you. If you wait too long, the line will go up rather than out. After the release, the rest of the line will play off the open palm of your other hand. The line should fall over the shoulder of the victim in reach of his or her hands. If there is a cross-wind or current, throw to the upwind or upstream side of the victim. If you miss, recoil quickly and try again. Watch the victim and not the line when recoiling.

When the victim grasps the line, drop the remaining coil, if any, and reach out with one hand to grip the rope with your thumb inward. Pull in the line with that hand while you reach out with the other. Continue to alternate pulling and reaching with each hand until the victim is at the side or stands in shallow water. You need to pull fast enough to keep the victim afloat, but do not jerk the line from his or her hands. Provide the victim with instructions and encouragement.

A **ring buoy** is coiled and thrown in the same fashion as a heaving line, except that there is no need to separate the line into two coils. The buoy provides sufficient weight for an accurate throw. Some ring buoys come with the line in a plastic scoop wedged within the ring. Such an arrangement keeps the line from tangling. More often, the line for the ring buoy will be coiled. If so, give it a try as is, but be prepared for the line to tangle. If it does, re-coil the line with your hand on your knee like you would for a heaving line.

Throw the buoy beyond the victim with the line falling over their shoulder. Then pull the buoy to them. Tell the victim to get a good grip on the buoy before you pull them in.

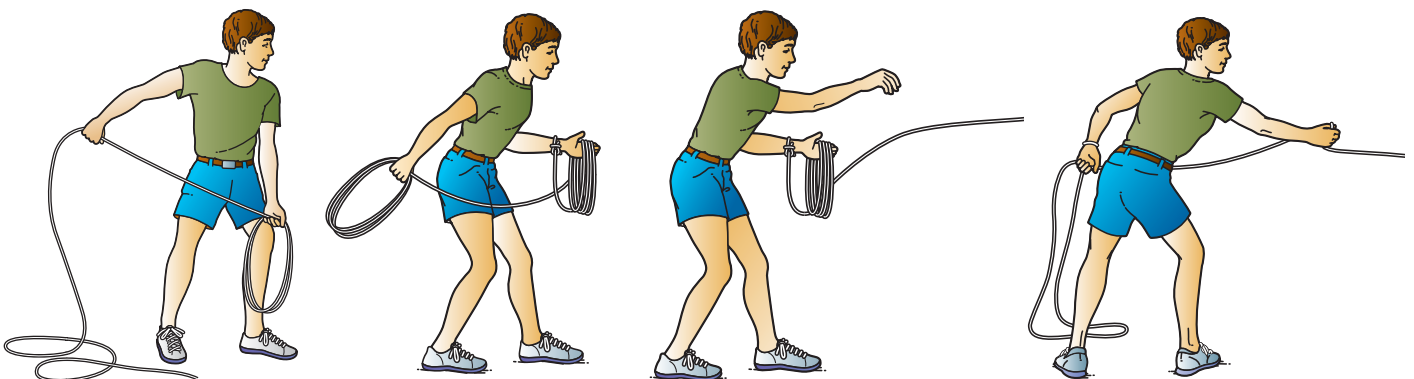

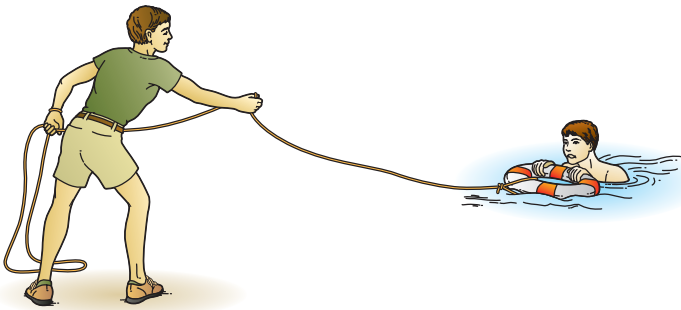

If the line plays out clearly, but your aim is off, you do not have to re-coil the line for a second try like you would for a heaving line. Instead, you can drop the line at your feet as you pull in the buoy and then try again.

You may find a ring buoy with a large wood bead, or lemon, on the free end of the line rather than a wrist loop. If that's the case, you are meant to stand on the line with the lemon behind your foot. The wrist loop is easier to use, particularly if you're moving with the ring buoy to get to a better position or throwing it from a boat, but the lemon also works. One reason for placing a lemon on the line is to prevent the possibility that a nonswimmer using the buoy could be jerked into deep water. For a similar reason, be very cautious using a wrist loop for any line thrown into a current or from a moving boat.

A makeshift buoy for a home pool, boat, or troop swim kit can be made from a gallon plastic jug with about an inch of water inside. Attach 50 feet or so (at least enough to reach across your pool) of light line to the handle and tie a wrist bowline in the other end. Solid-core woven line that floats is best, but nylon will work. Ski rope can be used in a pinch. The jug is thrown underhand like a regular buoy.

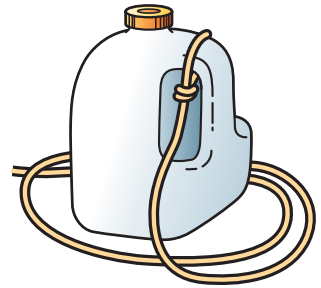

The **throw bag**, or rescue bag, is a common throwing device often carried on canoes and kayaks. It can be used at unit swims during float trips and makes a good addition to a unit safe swim kit since it is an easy way to store and transport a line. A floating line with a grab loop is stuffed into a small nylon tube with a float at the bottom. The float is not large enough to support a person but does keep the bag on the surface. You hold the loop in one hand and throw the bag underarm with the other. The line plays out of the bag as it travels through the air. An overhand toss can be used to clear weeds or a railing. A rescue bag is probably the easiest way to throw a line. It has the distinct advantage of always being ready for use. You do not have to worry about the line becoming tangled during storage or transport. If you miss your first toss, then use the rope as a regular heaving line. It's not easy to quickly restuff a wet line for a second throw.

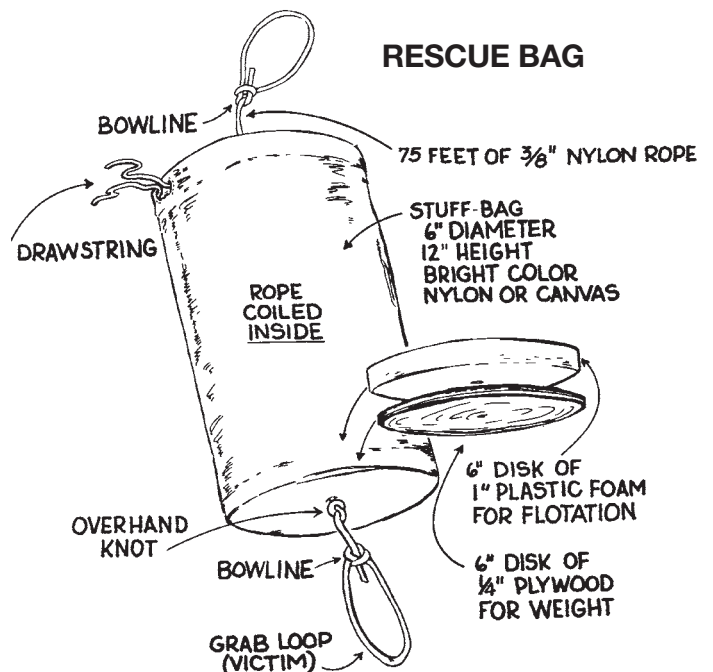

Although heaving lines, ring buoys, and rescue bags are extremely useful in some situations, it takes practice to use them correctly. If a throw line is provided for use at a unit swim, responders should practice until they can repeatedly hit near a stationary target. If they cannot do so, then it may be better to use the line to equip a pair of swimmers for a line-and-tender rescue.

Rowing Rescues

The term “rowing rescue” refers to the emergency use of any type of small craft, such as rowboats, canoes, or kayaks. Boats are appropriate guard tools for swimming sites in natural water bodies and should be used for that purpose whenever available. The specific skills required for the various craft are discussed in the Boating section of this text. Ideally, the craft should be crewed by two responders assigned as buddies. They should be equipped with reaching devices, such as poles, paddles, or oars, and flotation aids. As the boat approaches a conscious victim, the victim is thrown a flotation device or extended a pole and instructed to hold on and calm down. If the victim is unconscious, the rescuer in the stern of a rowboat or the bow of a canoe grasps the victim and holds them face up while the other person moves the craft to shore. Lifting an unconscious person aboard a boat is also an option but may be difficult. In a safe swim area, the shore should be close.

If a submerged victim is visible from the surface, one member of the team removes his or her life jacket, enters the water, and brings the victim to the boat.

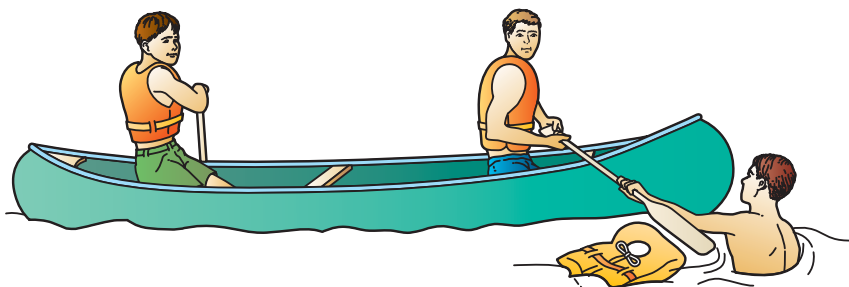
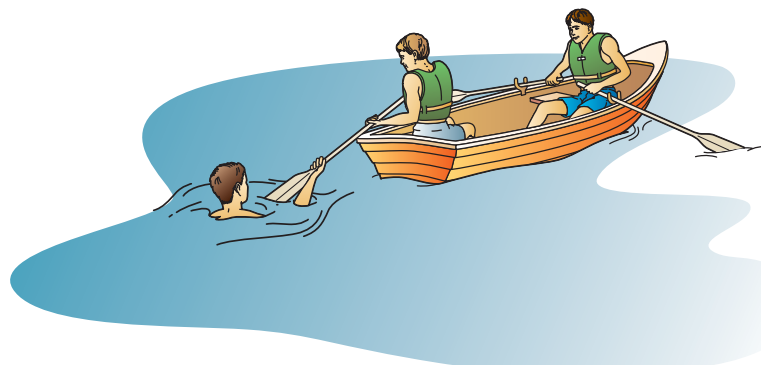

In-Water Assists Procedure

If possible, avoid contact with active subjects.



Contact is needed for unconscious subjects.



1. Recognize need, activate EAP.



2. Enter the water with pre-selected equipment.



3. Approach rapidly, keeping the subject in sight.



4. Provide support.



5. Move the subject to shore.



6. Assist or remove the subject from the water.



7. Provide care as needed.



In-Water Assists

The next several headings deal with in-water assists, which are divided into two classes depending on the need to touch, or contact, the victim. In **noncontact** swimming assists, the victim grasps the equipment you provide. In **contact rescues**, you grasp the victim and the aid. Noncontact rescues are the first choice for active victims. Contact rescues are required for unconscious subjects and those with a suspected spinal injury, but may also be needed for victims with seizures or other debilitating conditions. Either type of in-water assist should be performed only by skilled swimmers with proper equipment and training. An in-water assist involves an entry, an approach, a final assessment, and helping the victim to shore.

Appropriate rescue aids include a rescue tube; a ring buoy or floating cushion (Type IV life jackets); a life jacket or vest (Type II and III life jackets) that is worn or carried; other flotation aids such as an air mattress or foam rod; or a line tended from shore.

Entries

This section assumes that the area is free of hazards, that water depths are known, that rescue personnel do not need to enter the water from heights greater than 3 feet, and that rescue aids are available: all conditions appropriate for a safe unit swim area.

Beach Entry



If the swimming area is bordered by a shallow, sloping beach, enter at a run, lifting your legs high and holding your rescue aid out of the water. As the water deepens and running becomes difficult, lie on the surface and kick off the bottom. You can rest on a body board or air mattress, hold a rescue tube across your chest, or push a ring buoy or seat cushion ahead of you.

Noncontact Rescue

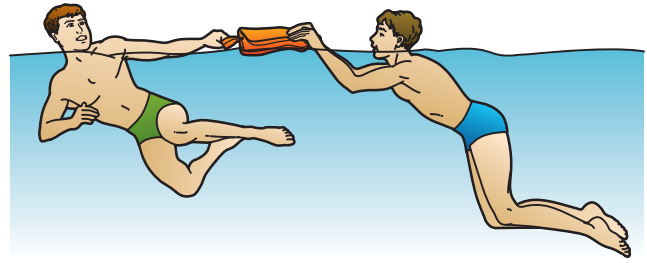

Contact Rescue

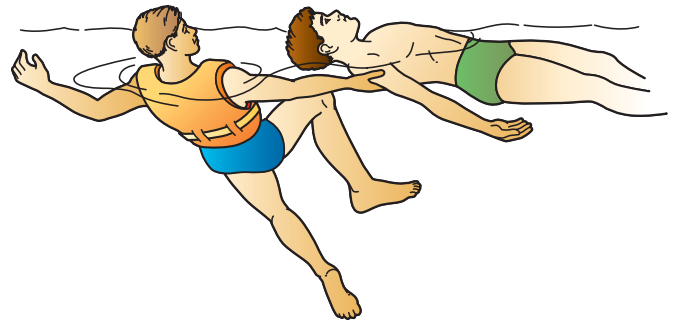

Ease-In Entry

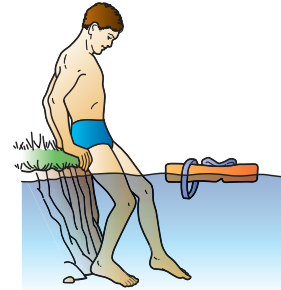

Use an ease-in entry from poolside or a dock into shallow water. Drop to a sitting position on the side and quickly slip into the water with your rescue aid. Begin swimming as soon as the water is deep enough.

Compact Jump



You can jump feetfirst into deep or shallow water from just above the water. Bend at the knees with the feet together. Keep your legs flexible and feet flat to absorb shock if hitting the bottom. Hold a soft rescue device across the chest. Make sure lines and straps are not tangled or caught on obstructions. The compact jump is also used for heights greater than 3 feet above the surface—from some high lifeguard stands, for example. Although such

heights may be appropriate for a lookout station, they are not recommended for unit response personnel.

Stride Jump

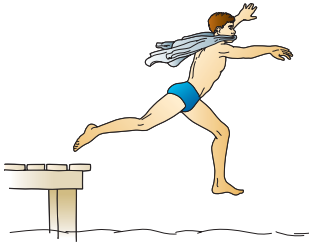

The stride jump, or leaping entry, allows you to keep the victim in sight as you enter deep water. It can be used from low heights, less than 3 feet, into unobstructed water at least 5 feet deep. Begin as if

you were trying to reach the victim in one giant step. You want to move out, not up. Spring outward while leaning slightly forward with your legs spread front and back in a scissors position and your arms outstretched. Snap your legs together and push down with your arms as each enters the water. If the entry is correctly done, your head will remain above the water. It might take several practice tries until you learn the proper timing for the downward thrust of the arms. A rescue tube or other soft flotation device can be placed under your arms and held to your chest. The flotation makes up for the lack of arm movement.

Approaches

The approach will generally be in a straight line from the entry point to the victim. Frequent visual observation must be maintained in case the victim submerges before being reached. Always give verbal instructions and encouragement when approaching a conscious victim.

The victim and rescuer will often be facing each other, and many rescues can be initiated from a **front approach**. However, some rescue techniques require rescuers to position themselves behind the victim in a **rear approach**.



Adapt your swimming stroke to the condition of the victim, the condition of the water, the type of aid being carried, and the distance. If the distance is fairly short, as it will be in most pools, then a head-up breaststroke is most versatile. You can swim with a buoyant aid, such as a rescue tube, beneath your arms. If that is too awkward, then the rescue device may be pushed with one or two hands extended in front. An alternative is to tow the aid using a sidestroke. Large objects such as surfboards or air mattresses can be ridden and propelled with the arms. The breaststroke is also useful in rough water.



A crawl may be used if the rescue device can be carried under the arms or is equipped with a shoulder strap and towline. At times the details of the approach stroke will be unimportant; for example, many backyard, apartment, and hotel pools are so small that the entry and approach are simultaneous.

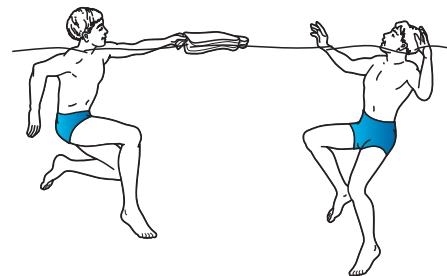

As you finish the approach, but just before you assist the victim, you should stop well out of reach, speak to the victim, and reevaluate the situation from a **ready position**. The victim could have become unconscious during your approach, or they could tell you that they hit their head and can no longer feel their legs. If the victim is able to respond, either verbally or by moving in your direction, you gain useful information for the assist. Be ready to back away from an active victim if needed, but it is not necessary to actually reverse direction if you stop a reasonable distance away.

Noncontact Assists for Conscious Subjects

There are several variations in how a flotation device can be used to assist an active victim in deep water. One possibility is to use a contact tow in which the rescuer grasps the victim from the rear and holds them against the rescue aid while swimming to shore. That technique is perhaps applicable to the widest range of victims, and will be discussed later, but it is not the simplest procedure and requires more stamina than others. The United States Lifesaving Association reports that most of the thousands of rescues performed yearly by lifeguards at beaches are accomplished from a front approach by extending a flotation device to the victim. That, in turn, leads to the following options:

Accompanied Rescue

In an accompanied rescue, the victim is allowed control of a flotation device provided by the rescuer. There is minimal risk of the victim grasping the rescuer, and the victim has the maximum support of the aid. The victim must be conscious, cooperative, and able to assist after becoming stable on the device. The aid must be buoyant enough to support the victim. This technique is suitable for a tired swimmer and may be attempted for all active victims. You should maintain a safe distance between yourself and the victim and be ready at all times to duck beneath the water and move away.

From a ready position, quickly tell the victim that help is at hand, that you will give them a float, and that they should grasp it firmly. If the victim begins to move toward you, gently push the float toward him or her while you back up. Don't assume that all victims will reach for the aid. The float may need to be pushed under the victim's arms or into contact with his or her hands. Some devices, such as cushions or ring buoys, can be pushed directly into the victim's chest. If the float is long and narrow, such as a rescue tube, air mattress, or foam rod, it should be swung from the end under the victim's arm or pushed to them sideways. A victim is more stable with their arms draped over the center of such a device than when trying to hold it to their chest in line with their body.

After the victim has become stable on the float, reassure them that they are safe and ask if they are able to kick their way toward shore. If the victim can do this, patiently escort them to the closest point of safety. That may not be the same place where you entered the water.

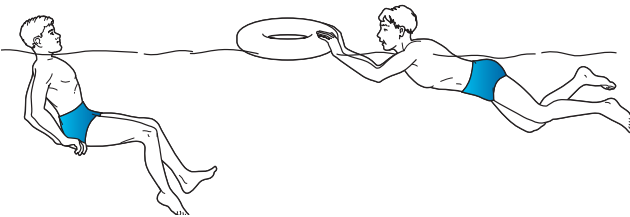
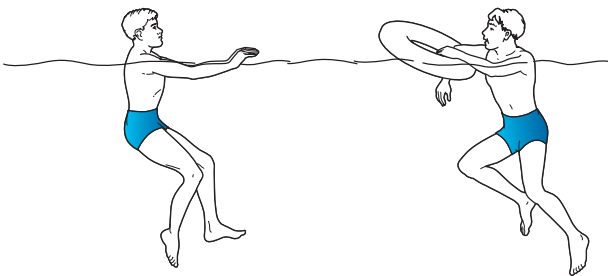
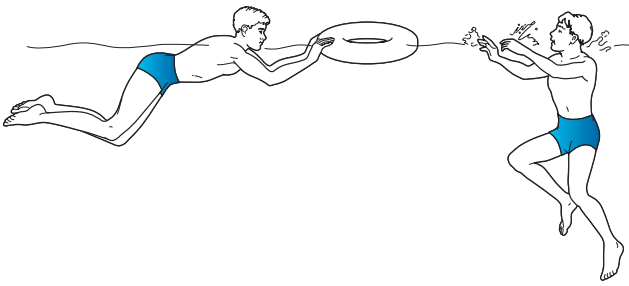

Noncontact Tow

If the victim is unable to make progress toward the shore but can support himself or herself with the aid, wait for them to grow calm and decide how best to tow them to shore. Always tell the victim in advance what you intend to do. Grasp the flotation device with one hand, extend your towing arm, and begin stroking away from the victim while holding onto the aid. Use a sidestroke for the tow. Continue to reassure the victim and encourage them to kick if appropriate. Watch for signs of exhaustion or panic. If the victim panics and tries to reach you, release the aid, quickly move away, and reassess the situation. Resume the tow only when it is safe to do so. At a unit swim, a second rescuer with another aid should be ready to respond if the first guard encounters any difficulty. This procedure is known as a noncontact tow since the rescuer is in contact with the flotation aid, not with the victim. Similar results may be achieved if the rescuer never releases the flotation device but instead begins towing after the victim grasps one end.

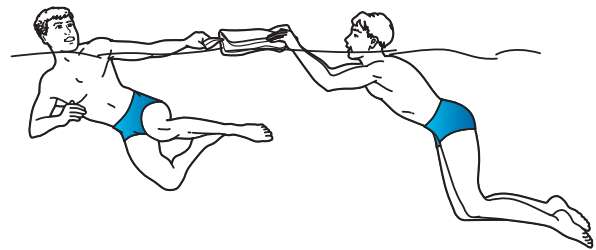
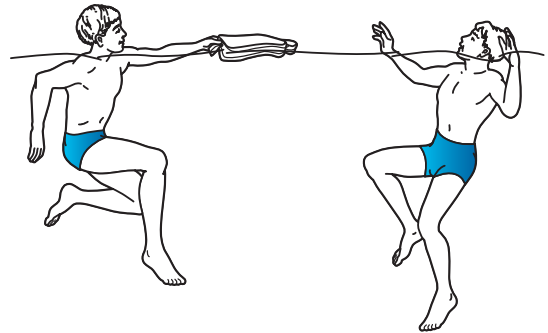
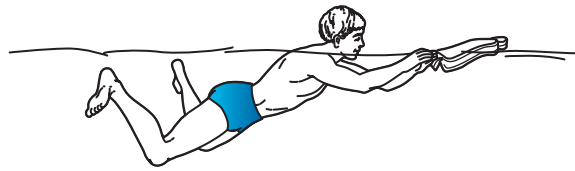

Shallow-Water Assist

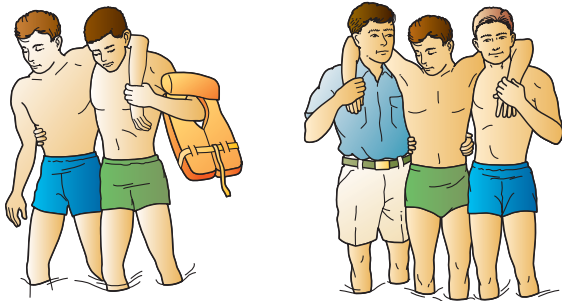

A conscious victim will probably be able to remove himself or herself from the water once they get sure footing on the bottom or a firm hold on a ladder. If the victim is exhausted, cold, or has trouble with their footing, you can help them ashore using a shallow-water assist. While standing at their side, help them to stand and to place one arm across your shoulder. Grasp the wrist of that arm with your outside hand, and wrap your free arm around their back. Then walk slowly together to shore. If the victim is much larger than you are, a second person can help from the other side.

Aftercare for a Conscious Victim

Even a victim who has been conscious throughout the rescue may need treatment for shock. If a medical condition, such as a stroke, led to the incident, summon EMS immediately or arrange for evacuation from a remote site. If the victim shows signs of hypothermia, move them quickly to warmth.

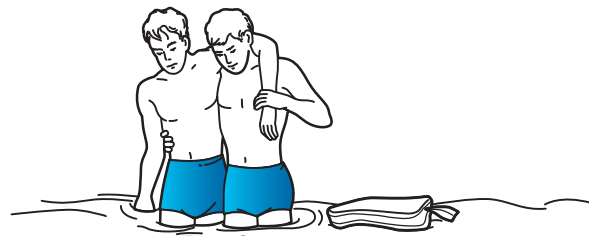

Contact Rescues for Unconscious Victims

If the victim is unconscious, floating facedown either at or beneath the surface, then the rescuer must necessarily make physical contact with the victim. Different techniques are available depending on whether the rescuer approaches from the rear or the front. Each technique is easily adapted for use with certain flotation aids but may be used without an aid, to bring the victim to the surface, for instance, or during a line-and-tender rescue. For ease of learning, each technique will be described first assuming that the rescuer is wearing a flotation aid, and then expanded to include using a separate flotation device to support the victim.

A front or rear approach can always be turned into the other simply by swimming around the victim. However, that might also necessitate reversing direction after the victim is in tow to reach a point of safety. The different techniques presented here provide the rescuer with options. Those assigned to emergency response at a specific unit swim site need not be equally skilled in all the techniques, so long as they know at least one technique to handle any likely situation. Just before a unit swim, assigned rescue personnel may need a practice drill.

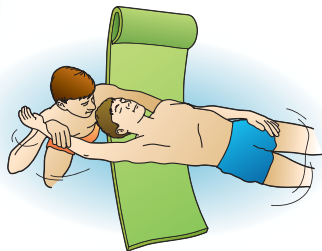
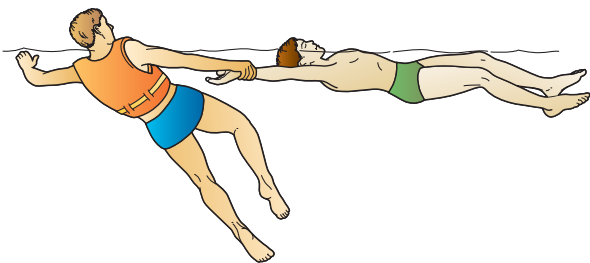
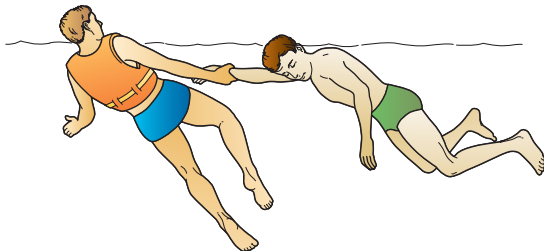
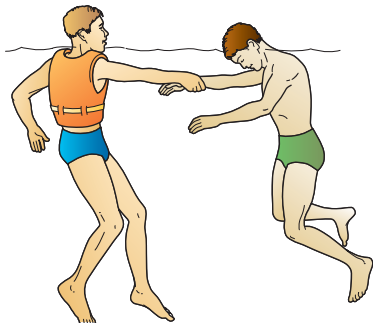

Wrist Tow (for Front Approach)

The **wrist tow** may be used if you approach a facedown victim from the front. It will work if the victim is at the surface, floating beneath the surface, or resting facedown on the bottom.

After you confirm that the victim is unconscious, come within an arm's length. Reach across to the victim's opposite wrist as if you were shaking hands, and take hold under their wrist with your palm up. Hold firmly and roll your wrist by turning your thumb up and over as you begin your tow. That twist in your wrist will turn the victim onto their back. Maintain the same grip as you tow the victim to safety with a sidestroke. A slight tension in your arm is needed to keep the victim faceup. Both your towing arm and the victim's arm should remain straight.

The wrist tow can also be used to place a flotation aid under the victim's shoulders and then followed by a **cross-chest tow**. Hold the aid with one hand while you reach across it with the other to grasp the victim's wrist. Lift up slightly as you twist the victim onto their back, and shove the float beneath him or her as they turn. You will then need to change your grip so that you can keep them on the float. Place one arm over the victim's shoulder and reach across their chest to grasp the aid with your hand. That should steady the victim on the float and leave your other arm free for swimming.

Armpit Tow (for Rear Approach)

A single armpit tow is begun from the rear for an unconscious victim at or very near the surface. Reach out with one hand and grasp the victim under their armpit with your thumb up and on the outside. (Your right hand goes to the right armpit, or your left hand to the left armpit.) Pull back with your arm and immediately begin swimming to shift the victim from a facedown to a face-up position. It may take a few strong strokes using both your legs and free arm to pull the victim onto their back. Once you have the victim fairly level, continue to shore with your towing arm extended. It is important to keep the victim's face out of the water.

If the victim is large, you may find it easier to pull them onto their back if you grasp both their armpits and lean backward while using a whip kick. If safety is only a short distance away, you can continue with a double armpit tow. Such a tow requires a strong, well-developed kick. Once the victim is level, you may find it quicker and less tiring to shift back to the single armpit tow.

The double armpit tow can also be modified for use with some buoyant aids, particularly if they are soft and relatively long and narrow, such as rescue tubes, foam rods, or air mattresses. Approach the victim from the rear with the float across your chest and under your arms. Scoop your elbows under the victim's armpits, grasp their shoulders, and then either roll over or lean back. Either action should pull the victim face up on top of the flotation device. A roll is probably easier for a large victim. Leaning back prepares the rescuer to return along the approach direction. The aid is held in place between the victim's back and your chest. Once under way, you may be able to let go of the victim with one hand so you can swim more effectively.

Submerged Victims

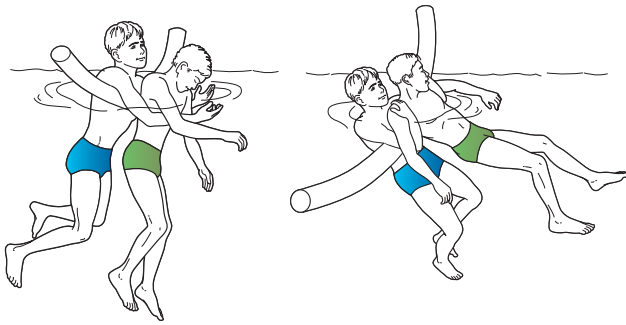

An unconscious victim can come to rest anywhere between the surface and the bottom. If the victim is floating just below the surface, you can reach down and use the wrist tow to bring them up and forward. If the victim is deeper, you will need to use a surface dive to get closer. A headfirst surface dive may be used in deep, clear water. If you have a flotation aid, leave it at the surface.

Grasp the submerged victim in any logical manner, either by the wrist, under one arm, or under both arms. If the victim is on the bottom, you can shove against it with your legs to help you up. In a small pool, the victim can be taken directly to the side since rescue breathing is needed as soon as possible. In a larger area, the victim may be placed on a flotation device to speed the swim back to shore.

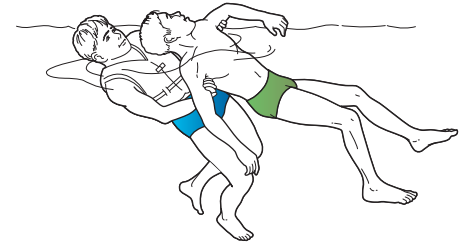
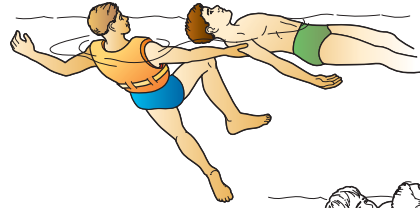
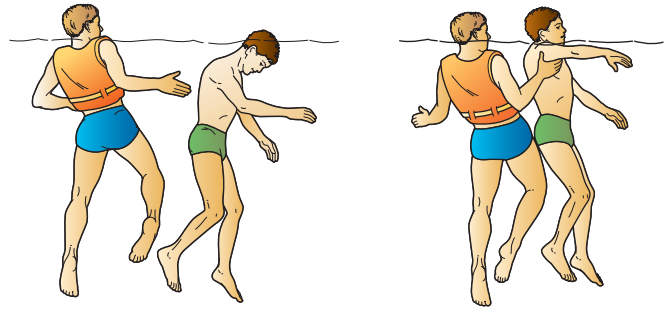
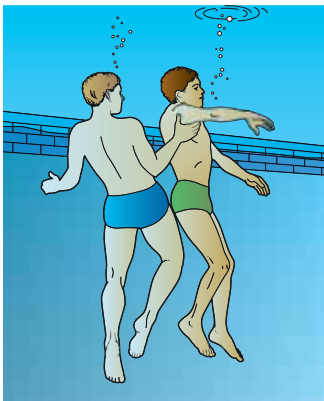

Rescue of a submerged victim is easiest if the water is clear enough for you to see both the victim and the bottom, and the water is relatively shallow. Recovery is more difficult, and in some cases impractical, if the water is murky and/or deep. If you saw the victim submerge as you approached, but you cannot see him or her from the surface, then you should do a feetfirst surface dive with the hope that you will make contact.

If you do not encounter the victim on the first dive, signal for help (which should already be on the way). Continue to surface dive in the immediate area but realize that you are also marking the location. Other rescuers can expand the search in a circle about your location. A search for a missing swimmer in an unknown location is different from the response for an observed submersion and will be discussed further.

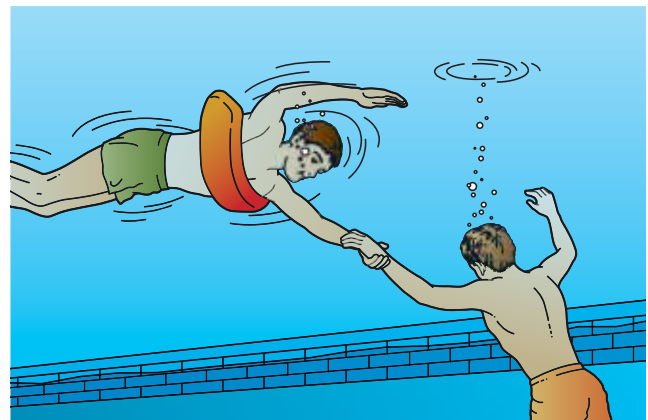

Landing an Unconscious Victim

The unconscious victim needs to be moved as quickly as possible to a location where breathing and pulse can be monitored and CPR performed if necessary. It is sometimes possible to start rescue breathing in shallow water or at the side of a boat. If that is not practical, or CPR is needed, remove the subject from the water and position on a rigid surface. Removing an unconscious victim from the water often requires more than one rescuer.

Beach Drag

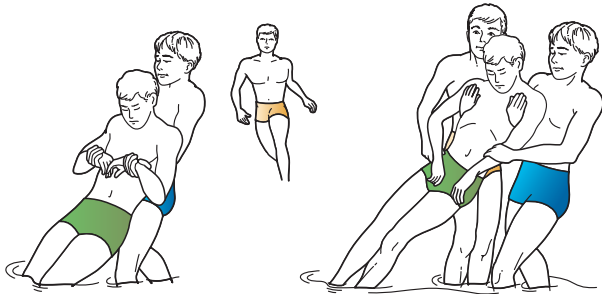

A drag is a relatively easy and safe way for one or more rescuers to remove an unconscious victim where there is a sloping bottom. During the tow, the victim will be on their back. Once your feet touch bottom, grasp the victim under their armpits and pull them onto the beach by slowly walking backward. Support the head with your forearms or against your chest and keep your back straight as you bear their weight with your arms. Gently lower the victim to the ground once they are clear of the water. If the victim is heavy, have someone help by taking hold under one of the victim's arms while you hold the other. Move slowly enough not to stumble on a rough or slippery bottom.

Vertical Lift



This technique is used for unconscious victims at the vertical edge of a pool or low pier or on a steep lake or riverbank. It needs from one to four people depending on the relative size of the people involved, the condition of the bank, and the depth of water at the edge. Ideally, two rescuers will be onshore above the victim and two more in the water on each side of the victim.

The initial rescuer tows the victim to the side and holds them facing the edge while the others get into position. The rescuers onshore crouch and each grasp one of the victim's arms, as near the armpit as is comfortable. If the water is shallow enough for them to stand, the rescuers in the water prepare to lift on each side of the victim's hips. On a signal, the rescuers lift the subject until their hips or thighs are level with the side. The victim is then lowered facedown to the ground with care taken to protect the head.

Next, roll the person onto his or her back. However, first make sure the hips are firmly supported. That may require sliding the victim forward.

Backboard Lift

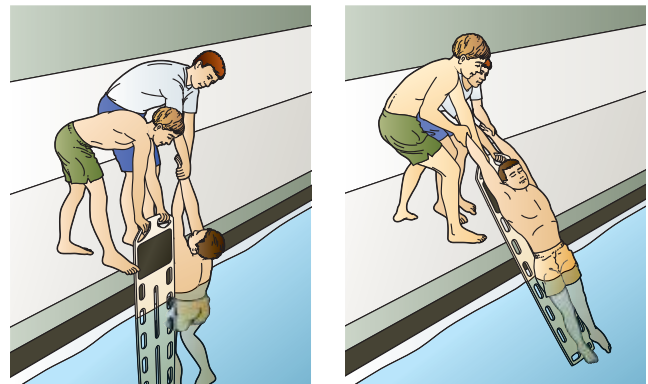

Backboards are sometimes required at hotel or apartment pools without lifeguards on duty. If a backboard is available, it can be used to help extract an unconscious person from the pool. Head restraints should be removed from the board before use. Two people on the deck are required.

The victim is turned facing the side while supported by a rescuer in the water. A rescuer on the deck crosses arms to grab the victim's opposite wrists and lifts enough to keep the victim's head out of the water. The second person on the deck slips the backboard vertically between the wall and the victim. The person holding the victim then turns the victim's back to the board by uncrossing the arms. Each rescuer grasps one wrist of the victim and the top of the board with their other hand. On signal, both rescuers pull the backboard with the victim over the deck, sliding it on the edge of the pool. The rescuers step back and lower the board to the deck. (Rescuers need to be wary of poor traction if the deck is wet and slippery.)



Aftercare for an Unconscious Victim

As the rescue of an unconscious victim begins, EMS or other advanced medical aid should be summoned. An unconscious victim will probably need rescue breathing and may need CPR.

If the victim is breathing but is still unconscious, place them in a recovery position and keep them warm until help arrives. Monitor vital signs.

If the victim regains consciousness, either on his or her own or as a result of your efforts at CPR, keep him or her inactive until EMS arrives. The victim might feel sufficiently recovered and wish to escape further attention, including the possibility of an ambulance trip to a hospital. But real danger remains. Victims who have aspirated water (that is, inhaled a small amount of water into their lungs) may collapse hours after the rescue. Inhaled water can irritate the lungs and cause them to fill with fluid from within the body. Foreign matter in the lungs can also lead to pneumonia. All submerged victims should undergo prompt medical evaluation. In remote locations, evacuation should be arranged.

Missing Submerged Victims

The rescue techniques discussed above assume prompt emergency recognition and response. However, what happens if a buddy check reveals a missing person or a missing buddy pair? If that happens, several Safe Swim Defense safeguards have failed. Despite preventive measures, a crisis developed that neither buddies nor the safety team (lookout and responders) were able to recognize. That should seldom, if ever, happen. However, the count taken during a buddy check provides a final alert mechanism. For Safe Swim Defense to work properly, that final safeguard must be unambiguous. If the unit leader first assumes that



the missing person or persons simply wandered off on land, and searches there first, then that leader has not properly implemented Safe Swim Defense standards requiring an accurate, current count of everyone in the water. If Safe Swim Defense guidelines are in place, then a missing person during a buddy check means a person is submerged in the water, and that is a major life-threatening emergency with the clock ticking ominously.

If the water is clear enough to see the bottom, then a search from the surface is relatively quick and easy, either from the side or from swimmers in the water. The first region to search is the ability area where the missing person was assigned. The search should then widen to cover the other ability areas and also just outside the boundaries, and under docks or in other restricted zones. If there is a current, first check the downstream perimeter.

If the bottom cannot be seen from the surface, then the situation is much more difficult and may be further hampered by waves or a current. In shallow water, use a line search with swimmers linking arms and traversing the area while shuffling their feet. Once anyone in the line gets to chest-deep water, the line should be directed back into shallow water. Crisscross the area until the subject is found or each part of the area has been searched at least twice.

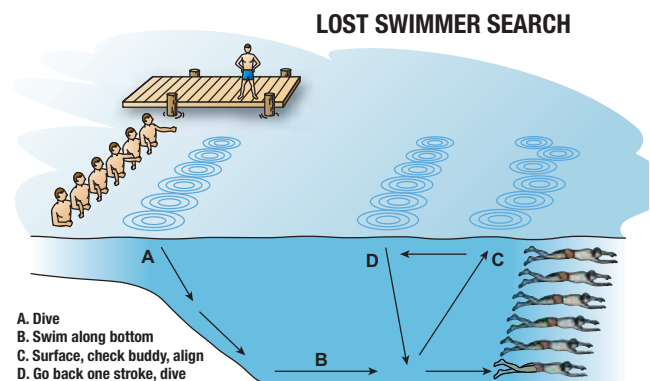

In deep water, only reliable, competent swimmers should be used in an underwater search for a submerged victim. An underwater search in turbid water is difficult and not without risk to the rescue team. At a Cub Scout event, only two or three adults may be deployed, whereas many members of a Venturing crew may be able to assist. However, time is critical. A prompt search with a few prepared individuals is better than a search delayed trying to organize and instruct a large team.

The divers form a line, surface dive together to the bottom, scour the bottom with their hands for a set number of strokes (typically three), and then surface. Buddies are checked every time the line surfaces. The line then reforms, backs up a bit, and dives again.

The adult supervisor should not allow the search to continue beyond the point that rescuers become exhausted. In anticipation of such difficulty, a unit swimming area in turbid water should be small enough in area, and shallow enough in depth, that the number of available search personnel can cover the bottom rapidly. If the unit leader is not confident of performing a safe, rapid, and effective underwater search in murky water, participants may be required to wear life jackets to minimize the possibility that anyone will submerge.

Contact Rescues for Conscious Victims

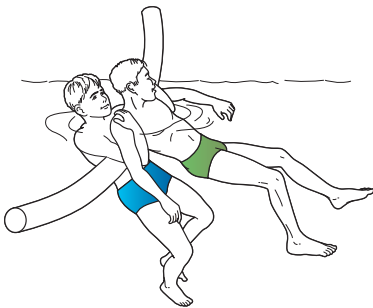

Noncontact assists are preferred for active victims. They are effective and they reduce the risk that the victim will grab the rescuer. In some situations, however, a conscious victim will be unable to grasp a

flotation aid. The victim may be incapacitated by a stroke or a seizure. An actively drowning victim may fail to grasp an object even after repeated attempts to place it under the victim's arms. In those cases, the rear approach and double armpit tow discussed for unconscious victims may be used, preferably with a flotation aid.

Defenses

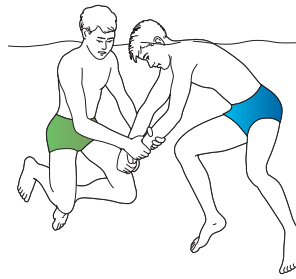

Rescuers using the rescue techniques discussed in this section should be at little risk from the victim. If the victim reaches for the rescuer rather than an aid, the rescuer should back off. However, if the victim grabs the rescuer, the

following techniques should resolve the situation.

An active distraught victim needs support to keep his or her head clear of the water. The concern is to breathe, not to purposely hold a rescuer beneath the water. Therefore, if a victim reaches for or grabs a rescuer, the first defense is for the rescuer to go underwater. The victim probably will let go on their own since they are trying to stay up rather than submerge. They certainly will not swim down after the rescuer.

At a unit swim, a rescuer in difficulty should quickly be assisted by a second rescuer, ideally with a flotation aid.

Wrist Escape

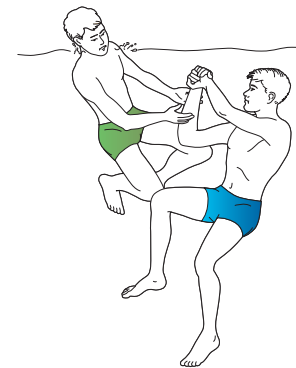

If a victim grabs your wrist, you have two options. If the victim is small and safety is near, you may decide to let him or her hang on while you quickly tow them to shore. However, if you are uncomfortable with the situation, you should break free. If the victim is holding your wrist with only one hand, break the

hold by quickly jerking your arm against their thumb. If the victim grasps your wrist or forearm with both hands, make a fist with your restrained hand, grab it with your free hand, and jerk them both upward. If that does not break the hold, push down with your arms to pull the victim lower in the water.

Rear Head-Hold Escape

If a victim grabs you around the neck or shoulders from the rear, take a quick breath, tuck your chin to the side, and submerge both yourself and the victim using the arm motion of a feetfirst surface dive. This action is known as *suck, tuck, and duck*. If the victim does not let go, grasp their upper arms near the elbows and shove upward. Swim clear of the victim before surfacing.

Front Head-Hold Escape

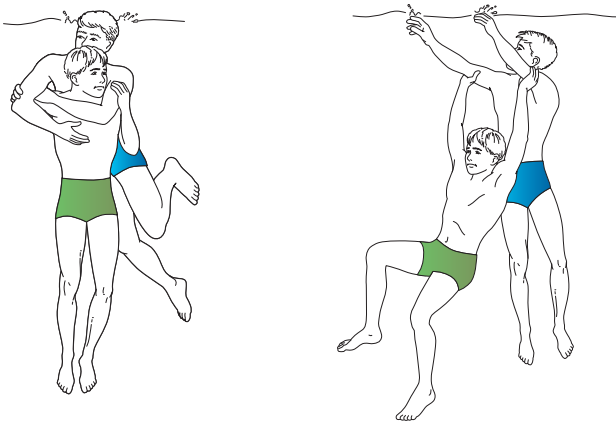

The same technique is used if the victim grabs you from the front. Take a quick breath (*suck*), pull your chin down and to the side so it doesn't hang on their arm (*tuck*), and submerge (*duck*). If the victim does not let go, push upward with your hands beneath their arms. You may also push a smaller victim up with your arms against their hips while you lean forward.

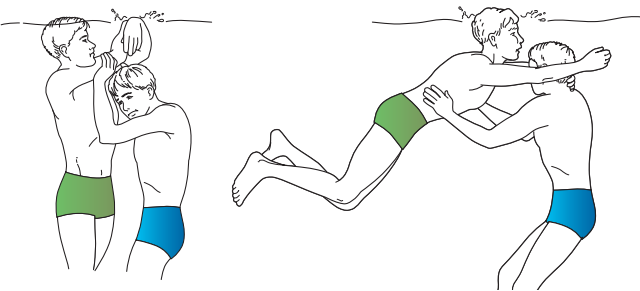

Stabilization of Spinal Injury Victims



Diving into shallow or unclear water is dangerous and foolish. The diver faces an unnecessary risk of spinal injury, permanent paralysis, and death. In pools, diving injuries occur most often when a swimmer dives from the side into shallow water, but can also take place if the diver hits

another swimmer or a diving board. When the bottom slopes gently into deep water, a swimmer attempting a shallow dive may hit the bottom, particularly at a surf beach where the water depth varies between swells. All participants at a unit swim should be warned about the dangers of diving, and only allowed to enter the water headfirst if the height, water depth, and water clarity conform to Safe Swim Defense guidelines.

If a spinal injury is suspected at a unit swim site, EMS or other advanced medical care must be summoned immediately. Spinal injuries are extremely serious and require special equipment. The unit leaders' task is to provide in-line stabilization until advanced help arrives to place the victim on a backboard. Stabilization includes turning a victim face up and holding them to lessen further movement. Even though any movement of the victim may worsen a spinal injury, a victim must not be left floating facedown; death by drowning is a greater concern. If the victim was found facedown, he or she may also require rescue breathing.

Suspect a neck or spinal injury anytime a person strikes their head on anything but the water during a dive, particularly if the person is immobile or unconscious upon surfacing. If there is a suspicion of spinal injury, assume the worst. Initiate in-line stabilization and check for breathing. Other symptoms, which may be observed after the victim is stabilized face up, include a lack of feeling or the inability to move hands or feet. However, don't release in-line stabilization even if the victim has feeling or movement. Wait for EMS to make an evaluation.

At the first indication of a spinal injury, take steps to stop everyone in the water. An immediate buddy check may not be appropriate in a crowded area because swimmers converging on their buddies are likely to jostle the victim. After the rescuer has made contact, account for everyone else and have them carefully exit the area.

Head and Chin Support

One technique to maintain in-line stabilization is to hold the victim's head while squeezing their chest between your forearms. If the victim is face up, approach from the side and lower your shoulders to the water. Speak to the victim if he or she is conscious. Place one forearm in the middle of the victim's chest and the other along their spine. Gently grasp the back of the victim's head with your lower hand and grip the jaw with your upper hand. Clamp the victim in position by squeezing your forearms together. A second rescuer should monitor vital signs and perform rescue breathing if necessary.

If the victim is facedown, again approach from the side. You may need to move the victim's nearest arm to their side. Do so by grasping their shoulder with one hand and using the other to move the arm into position. Lower yourself to shoulder depth. Next, place your arms and hands as before to support the victim's head. After you

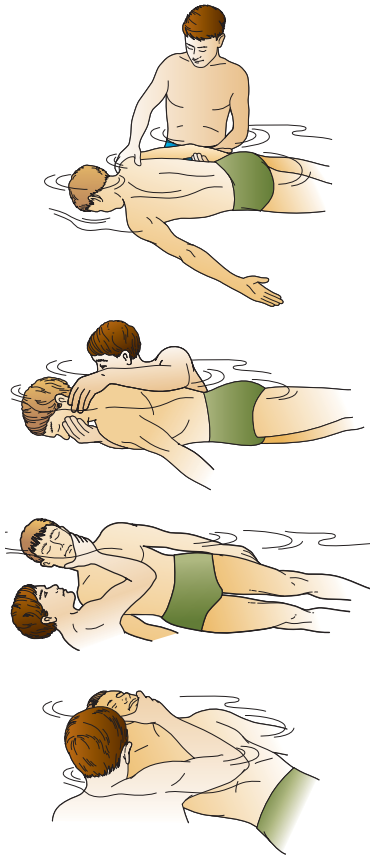

have clamped the victim's chest between your arms, begin moving slowly forward. Roll the victim toward you, take a breath, and turn the victim faceup as you roll beneath them. Avoid lifting or pulling down on the victim during the roll. The water must be around 3 feet or greater in depth to perform the roll without lifting the victim.

Head Splint

Another technique is to squeeze the victim's head between his or her arms. If the victim is facedown, approach them carefully from the side. Stand near his or

her head facing slightly forward. Since the victim's arms may be dangling at their side, the first step is to move them forward alongside their head. Reach across with your near arm and grasp the victim's outside arm (right-to-right or left-to-left) between the elbow and the shoulder with your thumb toward their hand. Grasp their other arm similarly with your free hand. Carefully swing their arms forward until they are near his or her ears.

Once the arms are in position, squeeze them both at the same time against the victim's head to trap it in place. Next, pull the victim slowly forward at the same time you roll them face up. You turn the victim by pushing down on his or her near arm and pulling their far arm across. As you roll the victim, your own body should twist slightly to face their feet. Lower yourself in the water as needed to prevent lifting the victim. Ideally, you should be at shoulder depth, but that may be difficult in very shallow water.

After you roll the victim face up, continue to hold their head in place with pressure on their arms. You can brace one hand against your shoulder to make it easier. Check to see if the victim is breathing; if he or she is not, have a second rescuer start rescue breathing and check for a pulse.

If the victim is initially face up, you approach from behind the victim's head and pull their arms into position as you face their feet. That will place you squatting with both your arms beneath their head. You can also approach from the side while facing their head. Reach one arm across the victim's chest to squeeze their arms against their head. That approach allows you to kneel in very shallow water.

If the victim is in deep water, both the head splint and the head-and-chin support techniques can be applied while the person is simultaneously moved to shallow water. The rescuer needs strong swimming skills, particularly a rotary kick.

Maintain in-line stabilization until EMS arrives with trained personnel and a backboard. Unit leaders are not expected to have the necessary equipment at a unit swim site to safely remove such a victim from the water. However, if a victim of spinal injury does not have a pulse, then CPR will be needed, and cannot be performed effectively in the water. If EMS has not arrived by the time that in-line stabilization is established, a person without breathing and circulation should be removed from the water with as little movement of the head, neck, and back as practical given the need for prompt first aid. Several people may be able to lift the person horizontally from the water onto the side of a pool.

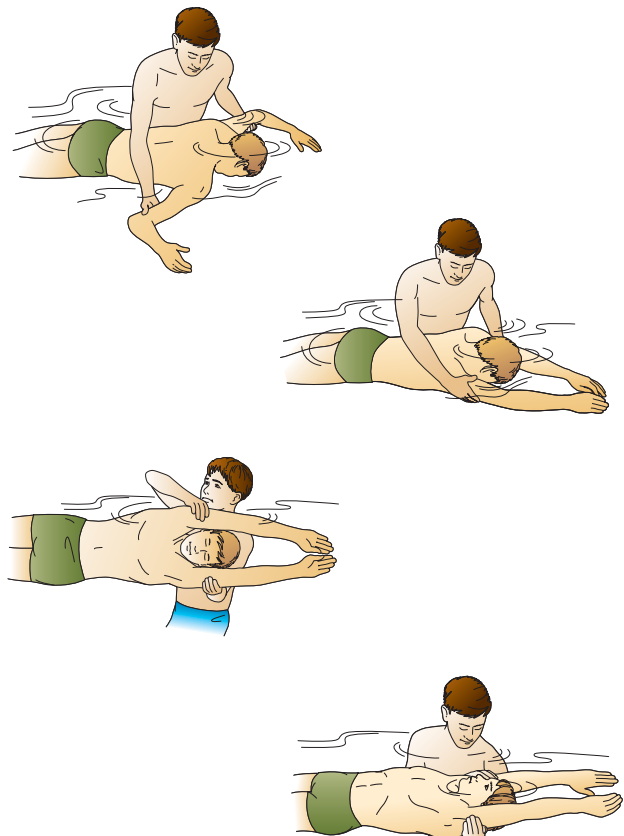

A spinal injury managed with care may still have dire consequences. Prevention is better than any treatment. Be sure to cover the dangers of diving during the tailgate review before a swim, and diligently enforce the policies on headfirst entry.

Line and Tender

The line-and-tender procedure uses a buddy team to effect a rescue. A rope or line tended by one buddy onshore is carried to a victim in the water by the other buddy. The onshore buddy then pulls both the victim and the line carrier to safety.

The procedure can involve elements of other rescue techniques. It is similar to a throwing rescue of an active victim using a line, but accuracy is achieved by the line carrier swimming past the victim and pulling the line into contact. If a flotation device is available, the line carrier may shove it to the victim. If the victim is unconscious, the line carrier can use a wrist tow or armpit tow to grasp the victim, above or below the surface. In each situation, both the victim and the rescuer are pulled back to shore with the line.

The procedure is simple, requires little equipment or training, and provides extra safety for the rescuer. The only critical skills are that one person be a good swimmer and that the other have sufficient strength to pull two people through the water.

The rescue line should be around 3/8-inch in diameter and long enough to cover the swimming area. Floating line is preferred, but nylon may be used. The line in a throw bag is ideal, and the bag provides an easy way to store and

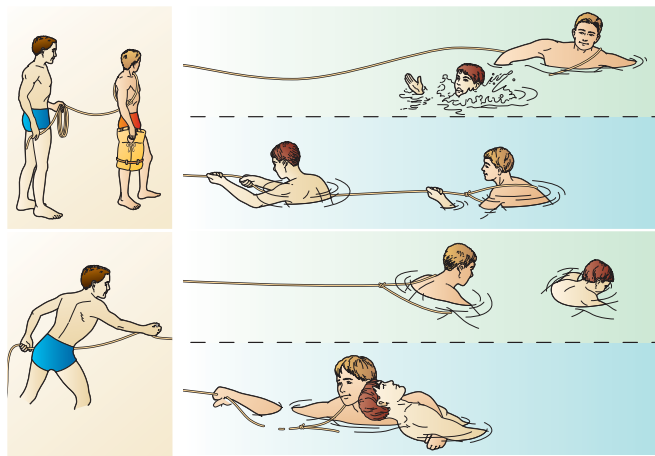

transport the line. To prepare the line, a bowline loop is tied in one end of the rescue line and placed over one shoulder and under the opposite arm of the line carrier. The loop should be snug enough to ensure that it will not come off while the line carrier is swimming or being pulled in. The team should be positioned within easy reach of all deep water used for swimming (approximately 50 feet).

When a person needs help, the line carrier makes an appropriate entry and swims quickly toward the victim. The line carrier swims past an active victim and then turns to bring the line to the victim's side. After the victim grasps the line, the line tender pulls in both the victim and the line carrier.

If the victim cannot grasp the line (is unconscious or incapacitated, for example), the rescuer grasps the victim. Although a wrist tow or armpit tow is appropriate, the rescuer need not be skilled in the use of those techniques. Any secure hold will work since the rescuer is not required to tow as well as to hold onto the victim.

The rescuer tending the line is first responsible for feeding out the line to prevent tangling as the line carrier delivers the line to the victim. The line should be ready in a neat, loose coil or in a throw bag. The line tender then pulls in their partner and the victim hand-over-hand, grasping the rope with thumbs toward himself or herself to kink the rope to prevent it from slipping. The line tender must be well braced on shore or dock and must have sufficient strength and weight to pull in their partner and the victim. A strong, rapid pull will keep the line carrier and victim at the surface.



The line-and-tender procedure is similar in concept to the reel rescues responsible for saving thousands of lives on the beaches of Australia and New Zealand before the adoption of motorized inflatable rescue boats.



The procedure should be practiced until both team members are capable and confident in their roles. All unit members should understand the procedure and know to “clear the way” when the team is responding. This need for practice and understanding is one important reason the line-and-tender rescue is a First Class rank requirement.

The line-and-tender procedure may be augmented with flotation aids. The line carrier may wear a life jacket and/or carry a flotation aid.

Note that the line-and-tender procedure is not recommended when there are obstructions, such as submerged trees, in the water. However, such conditions would violate the criteria for a safe area.

The line-and-tender procedure is appropriate wherever there is an expanse of deep water beyond easy reach from poolside, shore, or dock, particularly if team members lack extensive rescue training. More than one line-and-tender team may be stationed as needed along the shore, on a pier, or on a detached floating dock. However, other response teams may depend on reach poles or a boat rather than a line. Reaching and wading rescues will provide adequate coverage at many small, residential in-ground or above-ground pools. Therefore a line-and-tender team need not be deployed in all situations.

“Every Scout a swimmer, every swimmer a lifesaver”

completes the early slogan. The Boy Scouts of America still recognizes the validity of that goal. Basic water-rescue techniques are included in rank advancement, and the Emergency Preparedness or Lifesaving merit badge is required for Eagle Scout rank. Records from the National Court of Honor show that Scouts of all ages do encounter emergency situations where they are the person best prepared to respond. In those situations, they will respond with or without training. A goal of BSA programs is to equip them to respond safely and effectively. The proper use of youth members in the protection of unit swimming activities supports that goal.

During the early days of Scouting, it was noted that some Scouts lost their lives in the attempt to aid others, either from head injuries sustained when diving into unknown water or the inability to deal in the water with an active victim. Procedures still followed today, such as the leaping entry; emphasis on *reach, throw, row, go* as the proper sequence; and the use of equipment during swimming assists, were all introduced or adopted by the BSA years ago.

Note that water rescue training needs to be age appropriate. For Cub Scouts, a simple admonition to *reach, throw, go for help* is more fitting than a detailed explanation of *reach, throw, row, go*, but the first is still consistent with and leads to the second as the youth matures.





Safety Team Preparation

Every Scout a swimmer, every swimmer a lifesaver is still a goal. However, simply having trained rescuers at hand does not constitute adequate preparation to prevent and safely respond to drowning emergencies at a unit swim. The unit leader, the qualified supervisor, the lookout, and emergency response personnel are all important components of a safety team. Each needs to understand their function and how it relates to the others, even though a single individual may serve in more than one role. Safe Swim Defense defines those functions, but this section expands on the duties and interactions of team members, particularly during a crisis. Team members need to be provided with the necessary equipment, coached in an emergency action plan, and deployed to cover the area effectively.

- **The unit leader** makes sure there is a trained adult present to serve as the qualified supervisor for the swim. If the unit leader does not fill that position, then the leader provides unit resources and support to that person. If the unit leader serves as the qualified supervisor, then he or she should recruit at least one other adult as an assistant to help with discipline, particularly during an emergency, and to satisfy Youth Protection policies.
- **The qualified supervisor** reviews health information and ability group classifications, guides the setup of the areas, makes lookout and emergency response assignments, deploys those people to provide effective surveillance, ensures that appropriate rescue aids and communication devices are available, develops and explains the emergency action plan for the event, coordinates execution of the plan during a crisis, and assigns someone to check participants in and out of the area if needed.
- **The lookout** maintains a constant watch to ensure that all elements of Safe Swim Defense are working. The lookout normally calls buddy checks and clears the pool if needed during emergencies. Although not required to assist in water rescues, the lookout may do so if qualified, but only after the safety of everyone else in the group is established. If the qualified supervisor serves as the lookout, he or she must assume no other duties, such as providing stroke instruction or grilling hamburgers.
- **Response personnel** are designated by the qualified supervisor to closely monitor the activity and respond during emergencies. The emergency action plan should clarify the roles of each individual responder—for example, who reacts to an emergency in one part of the swimming area, and what the others do to maintain the safety of everyone else during such a situation. The responder’s monitoring role is just as important as emergency response. Each person needs to continuously scan his or her assigned area. The ratio of responders to swimmers is 1-to-10; however, different unit members may rotate in the role during the course of the activity. The qualified supervisor may also serve as a responder.

Surveillance

According to Safe Swim Defense: **Every swimming activity must be closely and continuously monitored by a trained rescue team on the alert for and ready to respond during emergencies.** The underlining is added to emphasize that surveillance is a primary function of response personnel. Recognition of that function is a key component in swimmer protection. Unit leadership is responsible for providing sufficient instructions to the safety team to minimize the risk of an unobserved submersion.

Emergency response personnel and lookouts are observers who watch for the characteristics of a swimmer at risk. They should be positioned such that all swimmers are constantly scrutinized, and they must not engage in any activities that divert their attention from that surveillance. In rare situations, such as a snorkeling excursion away from an anchored boat, responders may be deployed in the water with swimmers. Normally, watchers should be elevated above the water. For the small, uncrowded areas typical of a unit swim, a standing position is normally adequate. A poolside position also helps with discipline and provides for rapid response. Visibility at larger areas is improved if elevated stands are available.

Observers should be able to see all of their assigned area with little head movement and should not be facing into the sun or glare. Sunglasses with polarized lenses and UV protection aid visibility and protect the eyes.

For small areas, observers may be assigned to watch the entire area (**total coverage**). They should do so from different vantage points and be in sight of at least one other person on surveillance duty. Each responder should be assigned a buddy who provides backup for the rescue. (For example, the backup may be a line tender for a line rescue.) In turbid water conditions, the responder’s buddy should act as a spotter in case the victim submerges before being reached.

For larger areas, responders should be assigned to cover specific areas, such as the deep end past a ladder, or the beginner area from line to line (**zone coverage**). There should be enough safety personnel to overlap surveillance of all areas by at least 100 percent. Typically, a lookout will provide total coverage of the entire area while response teams provide zone coverage of limited extent. That type of overlapping surveillance is known as **combined coverage**.

When zones are used, they should be clearly defined by distinct features, such as lines, ladders, or docks. Vague instructions, such as “halfway across” or an imaginary circle on a diagram, can lead to confusion where one area meets another.

Dual coverage of the area by others is important because it allows a safety team member to momentarily interrupt scanning to deal with minor problems without leaving the area unattended. For example, a responder may need to direct a swimmer with a nosebleed, and the swimmer’s buddy, to the adult supervisor. Or, the responder may need to call a swimmer to the side to caution against sunburn.

If a responder must enter the water for a rescue, that responder’s buddy provides backup assistance if needed. Other response teams should automatically increase their surveillance zones to help the lookout cover the area normally covered by the team performing the rescue.

Even though an observer’s assigned area should be small enough to view in its entirety, the observer should still perform a systematic scan so that swimmers in different parts of the area come under close observation. Visual sweeps may be from side-to-side, in-and-out, or varied, and should include both the surface and the bottom. The bottom immediately below the station should not be neglected. Sweeps may be interrupted to more closely examine motion caught by peripheral vision (out of the corner of the eye), but should quickly be resumed unless an emergency is noticed.

It is more important to focus on the swimmers than on a particular scanning pattern. Effective scanning requires deliberate attention to swimmer behavior. For small groups at unit swims, head counting is very effective. Update the count as swimmers enter or leave the zone. Between counts, scan the entire zone and track individuals (someone swimming underwater, for example); note group interactions, such as those playing a game; and look for signs that someone is in trouble or is breaking the rules. If a swimmer appears to be alone, the observer should immediately scan for the buddy. If it is apparent that the buddies are not watching each other, the observer should either catch their attention or call for a buddy check to remind buddies to stay together.

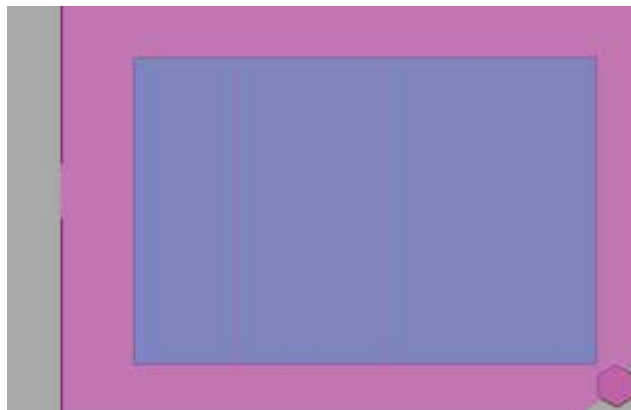

Total coverage

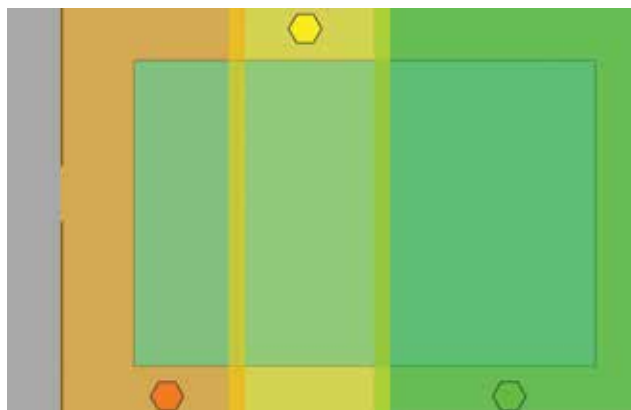

Zone coverage

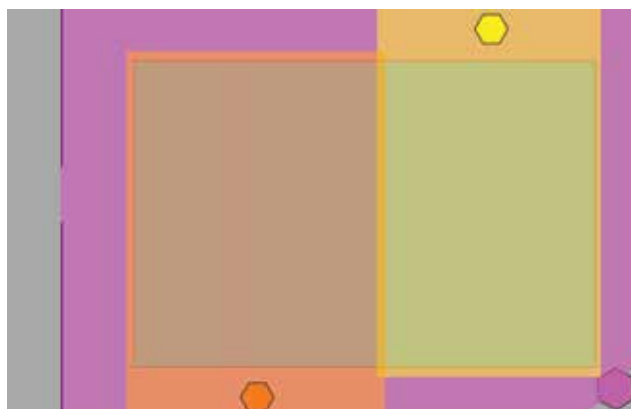

Combined coverage

A safety team member assigned surveillance duty is expected to intervene promptly to prevent accidents as well as to recognize and respond to emergencies. Those are the only tasks that should be undertaken. Observers should focus on the task at hand and not engage in casual conversation. If it is necessary to speak with a swimmer, the observer should do so quickly and continue to scan the area if possible. Effective scanning involves hearing as well as vision. Observers should not listen to music using earphones while on duty.

Unit members acting as observers at a unit swim should be changed frequently to allow as many as are qualified to serve, and to allow everyone the opportunity to have fun. The best time to change safety personnel is during a buddy check. A typical swimming activity should last only an hour or so. Adult observers with critical skills may serve for the entire time.

The lookout should be in a position to observe the entire swimming area as well as the deck or shore. His or her task is to make sure everything is as it should be, for example: responders are in position; distant clouds are not threatening; no one is entering or leaving without checking in or out. The lookout typically signals buddy checks and confirms the count. In an emergency, the lookout decides whether to sound an emergency signal and provides backup surveillance of the zone where the rescue is taking place. When one team responds, the lookout and other responders are responsible for emergency communication and the supervision of the rest of the swimmers.

The lookout serves the important functions listed below and is not a redundant observer who lacks the qualifications to be a rescuer. A comparable position at a public facility would be that of lifeguard captain. At a minimum, a good understanding of Safe Swim Defense is required. Often the qualified supervisor is the person best suited to serve as the lookout at a unit swim. A youth member may be designated as the lookout, but if he or she lacks the experience required to fulfill all the duties of the position, then the qualified supervisor should assume those roles and in effect serve as a backup lookout and/or responder.



A LOOKOUT SURVEYS THE ENTIRE AREA AND:

- ✓ **Looks for deviations from Safe Swim Defense**
- ✓ **Monitors the environment**
- ✓ **Provides backup surveillance during a rescue**

ADDITIONAL DUTIES MAY INCLUDE:

- ➔ **Conducting buddy checks**
- ➔ **Clearing the area during an emergency**

Communication

A rescue at a unit swim site may involve nothing more than a simple reaching assist to a person with a momentary cramp. However, any rescue, from simple to complex, should be considered a team effort. Such coordination requires communication. It is not necessary to equip all supervisory personnel with whistles and an elaborate code, but it is necessary to establish a few fundamental signals.

SUGGESTED SIGNALS:

BUDDY CHECK: One long whistle blast means everyone moves to their buddy and remains silent.



EMERGENCY: Repeated short whistle blasts mean everyone freezes silently in place and waits for instruction.

A single short blast of a whistle is often used at public facilities as a warning given to a particular individual to stop some action. If the whistle is overused for that purpose, swimmers can become accustomed to the sound and tend to ignore it. Although such a signal is sometimes useful, it should be used sparingly, if at all, at a unit swim. Direct verbal communication is recommended to correct inappropriate activity by a specific individual. A buddy check can be called to quell group infractions.

The signal for a buddy check should be simple and easily recognized, such as a single long blast of a whistle or an air horn. The signal for a buddy check does not normally indicate an emergency but can be used to clear the swimming area rapidly, particularly if unit members are required to sit on the side of a small pool as opposed to standing stationary in a lake. A buddy check is an appropriate part of an emergency action plan if a swimmer indicates that they can't find their buddy.

A buddy check can also be called to close down the activity for weather, or simply when the allotted time has passed. A separate "checkout" signal is not needed, and may actually slow down the final buddy check. The same signal used to call the buddy check can be sounded to resume swimming, or replaced with a simple verbal directive to "resume swimming." Since all swimmers should remain silent during the buddy check, voice communication is appropriate.

A specified emergency signal is needed to gain the attention of the entire group without the corresponding scramble for buddies. The call should alert everyone to stop what they are doing, freeze in place, and listen for instructions. The signal can be used to clear the way for a line-and-tender rescue or to prevent swimmers from colliding with someone in distress. It is also useful to minimize the possibility that another crisis will arise while the first situation is being resolved. Repeated short blasts of a whistle, or any other simple sequence distinct from the buddy check call, may be used. Both the "emergency" and "buddy check" signals should be sounded and explained to the group at the final procedural review before swimming begins.

During a crisis, response personnel react immediately to perform the necessary assist. The lookout decides whether it is appropriate to sound the call for a buddy check or an emergency. Normally, the area and numbers involved in a unit swim are small enough that responders, lookout, and unit leaders can communicate verbally without the need for special signals among themselves. That verbal communication can include a "call 9-1-1" directive to the person previously assigned to make the call.

Before the activity, means for contacting emergency medical services must be established. At urban locations, a phone call placed to 9-1-1 on either a landline or a cell phone is common, and 9-1-1 may summon a prompt response at some rural settings. If a mobile phone is used, make sure there is cell coverage, the phone is charged, and the person placing the call knows how to direct rescuers to the site. In remote areas, it may be necessary to dial some other number (e.g., a ranger station) or to first travel some distance to where a phone is available. Communication with emergency services is an important part of the emergency action plan.



9-1-1
Know local emergency numbers and arrange access to them.

Emergency Action Plans

Devising an emergency action plan may be simple or complex, but it should be a deliberate undertaking for all swimming activities. Swimming might be a side activity during an excursion such as a backpacking trek or a float trip. In that case, some components, such as arrangements for medical services and evacuation, will be part of the emergency action plan for the main activity. At a minimum, the following items should be considered. Note that all of these items should already be addressed by a facility emergency action plan if the unit is swimming where trained lifeguards are employed.

- **Incident director.** Safety team members should respond automatically to emergency situations without first seeking approval. However, there needs to be a single individual designated to step in and take charge if unexpected situations arise. That person is the qualified supervisor defined by Safe Swim Defense. If a unit leader aged 21 or older is assisted by someone of lesser age trained in water safety, then that person assumes this role. There should also be a second person designated to take charge if the emergency involves the primary individual. Recall that adult cardiac arrest is the most likely life-threatening emergency to arise during unit outings.
- **Safety team members (who and how many).** For a small crew of two adults and six youth, the two adults, if properly trained, may serve as the lookout and responders. For larger groups, there must be a lookout and sufficient responders to maintain a ratio of one responder for every 10 swimmers or fraction thereof. For example, a group of 35 swimmers requires one lookout and four responders.
- **Safety team deployment.** The lookout must be able to observe the entire activity. If the group is too large for that to be practical, then the group should be subdivided into separate swimming areas, each with its own complete safety team. Responders are best deployed as buddy pairs watching the same areas. If a line-and-tender procedure is used, then the buddy pair will be stationed at the same location. If other assists are appropriate, the pair may be separated—for example, standing with a reach pole or flotation device in waist-deep water at two corners of a *beginner* area. The qualified supervisor

is responsible for positioning responders to provide adequate coverage of all areas with due consideration of the training and maturity of the individual responders. The supervisor is also responsible for providing each responder with rescue devices suitable to the responder's level of training.

- **Safety team duties.** As a whole, the safety team has five primary duties: careful tracking of the number of people in the activity, continuous surveillance of assigned areas, intervening to stop rule infractions, intervening to provide emergency assistance, and providing backup surveillance and supervision of swimmers not involved in a rescue situation. Backup surveillance is automatically provided by designating a lookout separate from the responders. The supervisor is responsible for handling disciplinary problems.
- **Likely emergencies.** The supervisor should prepare the safety team to respond appropriately to active victims, unconscious victims (at or below the surface), and potential spinal injuries. The supervisor may elect to have specific safety team members respond to special situations—a spinal injury, for example—but in general each responder should be coached in how to provide assistance in likely scenarios.
- **Signals.** The emergency action plan should include audible signals for buddy checks and emergencies and assign a specific individual, such as the lookout, to decide when such signals are needed.
- **EMS.** Emergency medical services should be summoned promptly for any incident that involves a serious medical condition or victim submersion. The emergency action plan must specify how that is done. Parents should also be notified as soon as possible.
- **Weather.** All swimming activities should be curtailed whenever thunder and lightning threaten.
- **Tailgate review.** Finally, the supervisor should determine what aspects of the emergency action plan to review with participants just before the event.

Safe Swim Defense Kits

Various items are needed to set up and aid the safety team in protecting a unit swim. Depending on the location, some necessary equipment will already be on-site. For example, many hotel pools have a ring buoy, shepherd's crook, and house phone within the area. In other situations, the unit will need to carry support material with them. Some units maintain a simple "swim kit" in a bag that travels with the unit. Other units assemble a kit just before an outing with the items they know will be needed. Items may include:

- **Medical histories.** The qualified supervisor should review medical histories before the outing to determine any special precautions that may be necessary. Copies of the forms should also be carried on any remote trip and shared as appropriate with emergency medical personnel. Information on allergies and preexisting conditions may influence treatment options. Also, the forms allow parents to authorize emergency treatment if they cannot be reached.
- **Cell phone.** Portable phones are useful for emergency communications and notifying parents of changes in plans. Be sure to check coverage and battery charge.
- **Whistle.** Handy for signaling buddy checks or emergencies.
- **Boundary lines.** Light cord connected to floats can be used to define nonswimmer and beginner areas. Slightly thicker floating line is even better.

- **Balloons.** Balloons inflated on-site are easy to transport and make highly visible floats to define swim areas.
- **Anchors.** Rocks are often difficult to tie to; for anchors, nylon or plastic sacks carried in the kit may be stuffed with rocks or sand. Large fishing sinkers may also be used.
- **Rescue line.** Polypropylene line in 100-foot lengths can be used for throwing or line-and-tender rescues. Solid braided line is better than loosely woven line without a core. A throw bag is an easy way to transport and use the line.
- **Flotation devices.** Different types of life jackets are useful rescue aids. Foam "noodles," inflatable air mattresses, or rolled-up sleeping pads may also be used.
- **Buddy tags and portable boards.** A simple list of names on a piece of paper is adequate for tracking those in the water and their ability classification. Some units save their buddy tags from summer camp and use them with small, portable buddy boards. Other options include tongue depressors stuck in the sand, or wooden clothespins strung on a line. For those, waterproof markers are used to print names and color the ends by ability groups.

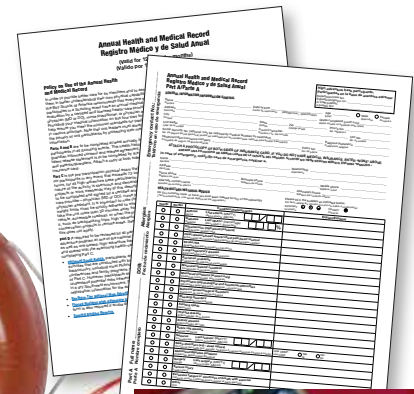

Tailgate Review

Area setup and emergency plans set the stage for a safe swim. A review of rules and procedures just before the swim clears the stage for the activity. A tailgate review should be short and simple, but include the following:

- **Entering and leaving the area**
- **Ability areas**
- **Any hazards to avoid**
- **Buddy assignments**
- **Buddy check purpose, signal, and response**
- **Emergency signal and response**

At a public facility with professional lifeguards, review the following:

- **Buddy assignments**
- **Appropriate water depths for different abilities**
- **Location of unit leaders**
- **Time and place to meet**





The Underwater World

Water covers most of the earth's surface. An extraordinary world of fantastic plants and animals awaits those who venture beneath the surface, whether the trip is at a nearby lake, along a tropical reef, or beneath the ice in the Arctic. The undersea world is too diverse to discuss in detail here, and seeing it in person is better than reading about it. The BSA has two programs, **Snorkeling BSA** and **Scuba BSA**, that provide introductory skills for Scout-aged youth and their leaders to contemplate an undersea journey. The **Scuba Diving** merit badge, and the Open Water Diver Certification it includes, prepares Scouts to experience recreational submarine excursions in accordance with the BSA scuba policy. The BSA Florida National High Adventure Sea Base provides the training and environment to make dreams of underwater adventures a reality for older youth.

Compared with surface land, much of the submarine world remains a wilderness. But those areas most accessible by people have suffered environmental damage similar to the open-air backcountry. Scouts know that caring for the environment is a key aspect of enjoying the outdoors, whether above or below the sea. Leave No Trace concepts apply to both worlds. Coral might look like a rock but is actually composed of living organisms. The general rule when snorkeling and diving is "**Look but don't touch.**" Not only does that rule protect the environment, it also protects the diver. Some sea creatures have defenses best not provoked. The skills discussed below are to be learned in clear, confined water. Before venturing into open water, learn more about the undersea ecosystem, both to protect it and to protect yourself.

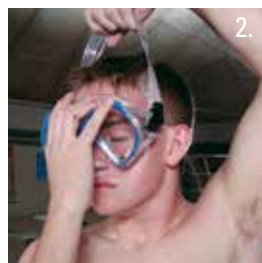

Mask Selection and Fit



The mask should have a single or double tempered-glass faceplate held to the skirt with a rigid band. The skirt, often of clear silicone, should have a double seal where it fits against the face. There should be a pocket so that the nose can be gripped with one hand for equalizing pressure in the ears. The strap should be easily adjustable and either split or wide where it fits across the back of the head.

To fit a mask, place it against your face without using the strap, then inhale gently through your nose. A mask properly sized and shaped for your face will remain in place. If the mask doesn't seal easily, try another style. Don't force the mask to remain in place by pushing down on the skirt and inhaling strongly. If the mask leaks underwater, or requires excessive strap pressure, the fit is poor.

To fit the strap, inhale to hold the mask in place, then use both hands to place the strap over the back of your head. If the strap is too tight, stop and loosen each side a notch or two. If the strap is too loose, tighten each side. Strap adjustments vary in style. Some have a hinged clip; on others, ridges are moved past a movable pin and held in place by friction and a slide. Figure out how to lock and unlock the device rather than forcing it. The strap should be only tight enough to hold the mask comfortably to your face. If the mask leaks, try a different style rather than pulling the strap too tight.

You can also don the mask back to front. Grasp the mask on each side with your thumbs hooked under the strap. Lift the mask over your head to position the strap on the back of your head, then pull the mask gently into place. The mask strap rides above the ears.

Warm air from your nose contains water vapor that will condense on the cool faceplate and block your vision. A few drops of a commercial antimist solution spread on the faceplate will prevent fogging. In a pinch, a bit of saliva will work, but not as well. New masks may have a residue on the faceplate that will contribute to fogging. Carefully wash a new mask to remove any such coatings.

The Snorkel

A snorkel is simply a short breathing tube from your mouth to the back of your head that allows you to breathe while looking down with your face in the water. The simplest designs are shaped like a J with a mouthpiece on the bent end. Other designs have contoured bends to better fit around the head. Still others have a flexible section near the mouthpiece. Although flexible sections may be corrugated on the outside, they should be smooth on the inside so that water is not caught in the ridges. Some snorkels have one-way purge valves near the mouthpiece. Others have “dry top” vents designed to keep out surface splashes. Regardless of design, the tube should have a diameter of about an inch (about the size of your thumb) and not be over 14 inches or so in length. A snorkel only works over short lengths. Never try to breathe through a hose to greater depths. The physics of the situation makes air exchange with the surface impossible, and the chemistry of rebreathing your own air causes problems. A few snorkel designs have flapper valves at the top to keep water out during submersion. Conventional purging techniques should be learned before using such systems.

Attach the snorkel to the mask strap using a “keeper,” which comes in various designs. Tucking the snorkel under the strap is not reliable and distorts the fit of the mask. The snorkel may be attached to either side. Scuba divers attach the snorkel on the left to avoid the regulator hose that comes over the right shoulder.



Fins

Fins are flexible, wedge-shaped flippers worn on the feet to improve the power of your kick. Blades come in a variety of designs, some long and narrow, some split, some with louvers, all claiming various improvements in efficiency. In general, the larger and more rigid the blade, the more power in the kick, but that also means tiring more quickly. The most important considerations are a comfortable fit and ease of use.

There are two basic types of fins: closed-heel and open-heel. Closed-heel fins fit over the entire foot and are often used for snorkeling in warm water. If one size is too tight, and the next larger size is too loose, then a pair of socks worn with the larger size may be useful. Some full-foot fins float, which can be handy if a fin is accidentally dropped in deep water.

Open-heel fins are designed to be worn with dive boots and are held in place by an adjustable strap. They are a good choice if a wet suit is needed in cool temperatures, but are also useful in warm water where booties provide foot protection on rocky beaches.

Fins should be put on wet, and ideally only when ready to use. Occasionally, walking in fins may be necessary—when wading through surf into deep water, for example. If so, walk backward, slowly and carefully.

Vest



An inflatable vest is a useful tool that adds to the enjoyment and the safety of open-water snorkeling. A few puffs of air in the oral inflation tube provide buoyancy while swimming out to a site or viewing it from the surface. The air is released through the same tube before a surface dive. Frequent use provides comfort and prevents exhaustion. A vest is not simply a backup device reserved for emergency use only, although it does provide an extra safeguard during a crisis.

Dive Flag



A dive flag should be used at open-water sites. Swimmers are hard to see in the water. A dive flag alerts boat operators to avoid the area. It may be displayed from a dive boat or attached to a float and towed with the snorkeling party. Local regulations require boats to stay a minimum distance from the flag (typically 100 feet) and may also mandate the size of the flag and how close snorkelers must stay to it (typically 50 feet).

Accessories

Useful accessories include a whistle attached to the vest as a signaling device, gloves to protect the hands, and protective clothing, either light everyday wear or special dive “skins,” to limit sun exposure on the back and legs. A mesh gear bag is handy for transporting gear to and from the site and allows the gear to dry after cleaning. In cooler waters, a wet suit provides comfort. However, a wet suit also provides buoyancy that may make surface dives more difficult. Experienced skin divers may wear weight belts with wet suits to achieve neutral buoyancy. Weights are not recommended for anyone who has not been trained in their use by a qualified instructor.



Snorkeling Skills

The following sequence of exercises covers skills required for Snorkeling BSA. It is not a complete teaching outline. Counselors for Snorkeling BSA need to review the requirements and decide how to best cover the skills and the cognitive material. Some items such as dive signals, the effect of water on sight and sound, and the need to equalize pressure are listed as distinct requirements but may be introduced and discussed as needed. Also note that some of the requirements cover items discussed elsewhere in this text; e.g., hyperventilation and hypothermia.

1. One buddy dons a mask and sits on the bottom in shallow water to check for leaks. The other buddy assists by standing behind the first and applying slight pressure on the shoulders to prevent floating. If the fit is acceptable, the pupil looks toward the underwater instructor, gives the underwater OK sign, and then surfaces when the instructor gives the UP sign (or before if needed).
2. The same buddy again sits on the bottom with the mask watching the instructor, who gives the Watch Me sign. The instructor deliberately floods his/her mask by pulling it slightly away from the face. When the mask is full, the instructor gives the OK sign, then the UP sign. After everyone is standing facing the instructor whose mask is full of water, the mask is drained by pulling it slightly away from the face. The pupils then do the exercise. This drill teaches the pupils not to become alarmed if the mask floods, but simply to surface and drain the water there. It also shows the difference in vision when the mask is filled with water rather than air. Once everyone is comfortable with the exercise, repeat 1 and 2 with the other buddy. (Note: Purging the mask while submerged is a scuba skill that may be shown as a bonus, but is intentionally not required for Snorkeling BSA.)
3. Without the mask, one buddy bends over and breathes through the snorkel. When tapped on the shoulder by the other buddy on signal from the instructor, the pupil squats to fill the snorkel with water, returns to the facedown position, purges the snorkel with a blast of air, and then carefully resumes breathing. The exercise is repeated several times before the other buddy is given a turn.



4. Without the mask or snorkel, one member of each buddy team puts on fins, slips into the water, grasps the side in a prone position, and makes slow, wide kicks in place. Once adjusted to the flutter kick with fins, the group walks backward away from the poolside or dock, turns, and swims on the surface using only the legs until reaching the other end of the swimming area. The head is turned to the side for air if needed. On the way back, have the group swim part of the distance slightly underwater. Repeat with the other set of buddies.
5. Repeat 4, this time with mask and snorkel.
6. Move to the deep end of the swimming area. Demonstrate and practice a slide-in entry, a stride entry, and exits at either the side or a ladder. For the slide-in entry, the person puts on fins from a sitting position on the poolside, dock, dive-boat swim platform, or side of an inflatable and then slips into the water using the arms for support.

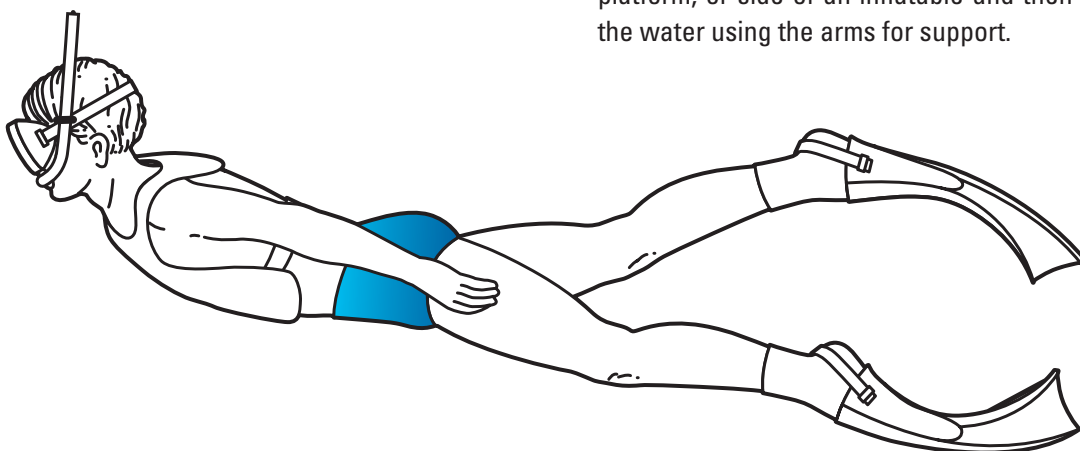

For the stride entry into deep water, one leg is extended over the water from a standing position with one hand holding the mask in place. The legs are brought together as they submerge. Have each person give the surface OK sign after the stride entry. To exit at the side or a ladder, the fins are first removed and handed up.

7. With everyone sitting on the side at the deep end, show how to pinch the nostrils through the mask. Have everyone pinch their nose and blow *gently* until their ears feel full. Have them repeat several times. Then have one set of buddies slide into the water, push down with one hand, and do the equalization procedure underwater. Repeat with the other set of buddies.
8. Demonstrate and practice headfirst and feetfirst surface dives one set of buddies at a time, or individually as needed. The arms lead the head during a headfirst descent and during headfirst ascents.
9. Set out a dive flag and have buddies work together to retrieve objects from the bottom, using DOWN signs as appropriate.
10. Demonstrate and practice the displacement method of clearing a snorkel. (Mastery of this method is not required for Snorkeling BSA.)
11. Demonstrate the DISTRESS sign, followed by demonstration and practice of floating and double armpit tow.

Diver Signals



OK? OK on surface



Help



Come here.



Danger



Me or watch me



Go up, going up



Go down, going down

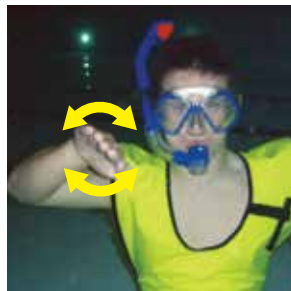

Something is wrong.



Slow down.



Stop.



OK? OK below surface

Dive Physics

Light. Light rays entering the eye are focused on the retina by the lens. However, with water rather than air against the lens, light rays enter the eye at a slightly different angle, and the lens has a hard time compensating. You can see underwater, but objects are out of focus. A mask provides an air space in front of the eye so that light bends as normal at the air-to-eye interface and the eye can focus on underwater objects. However, now the light rays bend entering the mask. The amount of bending is such that objects appear slightly larger and closer than they would in air. Your mind normally is able to adjust quickly to the differences.

Water molecules and suspended particles in the water scatter and absorb light. The deeper you go, the darker it gets, and colors become washed out. A dive light or camera flash will reveal the true colors if the water is clear. The effect is not pronounced enough to hide the myriad colors of a tropical reef at depths easily reached by snorkelers.

Sound. Sound travels about four times faster through water than through air. You can hear well underwater and for long distances. However, your ears use time differences to determine direction, and that ability is distorted underwater. Your ears will warn you of an approaching motorboat, but you may not know where it is coming from. Also, sound bounces off layers with different velocity and density. Because the speed of sound in air and air density are both so much less than those of water, sounds made above the surface probably won't be heard underwater. Therefore, you may not hear the whistle for a buddy check until you surface. (That's just one reason why buddies should take turns underwater.)

Pressure. Your body is used to a pressure of one atmosphere (the weight of the column of air from sea level to outer space) of around 14 pounds per square inch. Because water weighs much more than air, pressure underwater increases rapidly with depth. Every 33 feet or so, you add another atmosphere, but you may feel the difference at depths around 8 feet. As you descend, the water pressure outside your chest squeezes your lungs and raises the air pressure in them. If air is free to travel from your lungs to your middle ear, the pressure of the air on the inside of your eardrum will match the pressure of the water on the outside. Your ears won't feel any pressure difference because there is none.

However, if the Eustachian tubes that connect your lungs to your middle ear are blocked, the air pressure inside your ear remains the same as that at the surface, and pain will warn you of the mismatched pressure.

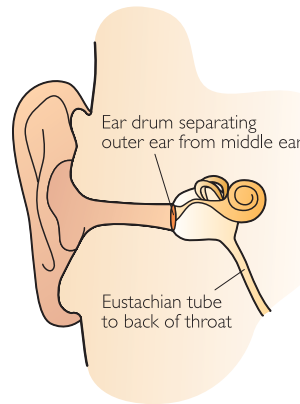

Some people can equalize the pressure in their ears simply by swallowing or moving their jaw. Most people will need to hold their nose and blow gently to move air through the Eustachian tube into the middle ear. That is why masks allow you to hold your nose from the outside. You can check your ability to equalize

before a dive by holding your nose and blowing just enough for your ears to feel momentarily stuffy. Such an exercise may make it easier to later adjust underwater. However, people congested with a cold or allergy may not be able to equalize the pressure and should not try hard to force it. You will still be able to enjoy snorkeling near the surface; you just won't be able to dive deeply. Return to the surface whenever the pressure in your ears warns you to do so.

Like your ears, your mask is another enclosed volume of air that needs to adjust to pressure changes. Mask "squeeze" is rare because the mask covers your nose, and breathing through your nose will equalize the pressure. By now you should understand why swim goggles are not substitutes for a dive mask: there is no means for pressure equalization. Some surface swimmers also use earplugs to keep water out of their ears. Snorkelers should not use earplugs since the pressure during a surface dive may force them deeper into the ear canal.

Many people correctly associate the **bends**, caused by the release of gases dissolved in the blood, and other hazards of scuba diving with changes in pressure. However, breath-hold divers don't have the same concerns. If you dive to the bottom of a pool while breathing from a scuba tank, you will need to clear your ears, but the situation is different. The pressure in your lungs goes up, not because they are squeezed, but because your air supply is under pressure. You breathe through a special valve, or regulator, that changes the high air pressure in your tank to match what you need at

a given depth. You need to release the pressure in your lungs as you ascend to prevent damage. **Scuba divers should never hold their breath!** Because skin divers don't overpressure their system from an external source, the same problems don't arise. That is one reason swimmers are safe trying surface dives on their own, but should never use scuba gear without qualified instruction.

Snorkeling Safety

Snorkeling Safety is the recommended procedure for conducting BSA swimming activities using masks, fins, and snorkels. Since snorkeling is a swimming activity, Safe Swim Defense guidelines apply. Snorkeling Safety clarifies and extends Safe Swim Defense concepts to situations encountered during training and open-water snorkeling.

1. Qualified Supervision



All swimming activity, including snorkeling, must be supervised by a mature and conscientious adult age 21 or older who understands and knowingly accepts responsibility for the well-being and safety of the youth members in his or her care;

who is experienced in the water and confident of his or her ability to respond in the event of an emergency; and who is trained in and committed to compliance with the eight points of *BSA Safe Swim Defense*.

An experienced snorkeler must supervise snorkeling instruction and open-water snorkeling activities. At a minimum, the supervisor must possess skills and knowledge matching the *Snorkeling BSA* award, and have experience with environments similar to those of the planned activity. The supervisor is responsible for compliance with each point of *BSA Snorkeling Safety*.

Unit leaders may rely on the expertise of other adults to supplement their knowledge and training. They may delegate the task of supervision, for example, when the unit is participating in a snorkeling activity conducted by a tour operator, provided they are satisfied that the operator's training and experience will provide a safe activity with appropriate safeguards.

2. Personal Health Review



A complete health history is required of all participants as evidence of fitness for snorkeling activities. Forms for minors must be signed by a parent. Participants should be asked to relate any recent incidents of illness or injury

just prior to the activity. Supervision and protection should be adjusted to anticipate any potential risks associated with individual health conditions. Recent sinus or ear infections may temporarily preclude surface dives while snorkeling. Those with known adverse reactions to stings from marine life, or with chronic conditions such as diabetes or asthma, may need special medications at hand. Adults with known risk factors for cardiovascular disease should not undertake strenuous activities without the advice of their physician. For significant health conditions, the adult supervisor should require an examination by a physician and should consult with parent, guardian, or caregiver for appropriate precautions.

3. Safe Area



Training in the use of snorkeling equipment shall be performed in clear water in a confined area that conforms to Safe Swim Defense guidelines. "Clear water" implies pool-like visibility. At a minimum, an 8-inch disk with

white and black quadrants at a depth of 8 feet should be recognizable from above the surface. "Confined area" denotes either a pool or an established summer camp swimming area with direct access from the shore or a dock.

Safe conditions for open-water swimming and snorkeling depend on water clarity, area definition, depth, access, and other environmental factors. Snorkeling is limited to clear water. "Open water" denotes a temporary swimming area of flexible extent in a natural body of water that may not be close to shore.

An open-water snorkeling area need not have physical boundary markers, but the activity should be restricted within a specified distance of a point onshore, an anchored vessel, a moving rescue craft, or a float with a dive flag attached. Generally, a 50-foot radius is recommended, and may be dictated by local regulations concerning the use of a dive flag. The area covered by the snorkeling group should be small enough to allow rapid assistance from rescue personnel.

Emergency response places limitations on safe water depth as well as water clarity and area. Response personnel should be able to quickly and easily reach the bottom, locate, recover, and transport a submerged victim to shore or vessel. At the start of the activity, and periodically if the group moves along a reef or other feature, the response personnel should check their ability to see and to reach the bottom. The group should be directed toward shallower water whenever the responders experience any difficulty. (In Safe Swim Defense, 12 feet is designated as a reasonable maximum depth. In practice, slightly shallower or deeper depths may be appropriate. Different personnel will be able to easily recover objects from different depths, particularly if wearing fins. The practical way to confirm a safe depth is to test that the bottom is within comfortable reach of all designated rescue personnel.)

Limited or distant access to the snorkeling area may require additional considerations. Underwater features close to a sloping beach or near an anchored vessel are ideal. If the snorkeling site is a considerable distance from a beach or permitted anchoring location, the ability to rest becomes important and may restrict the activity close to shallow water or dictate the use of inflatable vests and/or small response craft. Tide tables should be consulted in areas with large tidal changes, especially when beach access is at the base of a cliff. Snorkeling in a river may require an exit point downstream of the entry.

Snorkeling should not be done if water depth, clarity, or temperature; boat traffic; waves; or current, weather, marine life, or bottom conditions, including vegetation, are deemed unsafe by the qualified supervisor. Time in the water should be adjusted based on water temperature and sun exposure. Snorkeling at night is limited to lighted pools unless the activity is conducted at a BSA nationally accredited high-adventure base.



4. *Proper Equipment*

- A. All snorkeling equipment shall be properly fitted and in good repair.
- B. The use of inflatable snorkeling vests and personal flotation devices is at the discretion of the qualified supervisor based on local conditions and the abilities of the participants and responders. Use of individual flotation devices is required in open water whenever there is a noticeable current or swells, when the bottom is not visible from the surface (due to vegetation or limited visibility beyond 8 feet), or when the activity is an extended distance (greater than 50 yards) from shore or craft.
- C. A dive flag should be used at all open-water sites. It may be displayed from a dive boat or attached to a float and towed with the snorkeling party. Local rules and regulations may specify the type of flag and how close snorkelers must stay to it.
- D. Protective clothing may be worn. Gloves are appropriate in areas with sharp rocks or encrusted structures. A shirt or a diver's bodysuit will provide limited protection from sun, abrasion, or coral burns and minor insulation in warm water. In temperate water, a partial or full wet suit may be worn. Weight belts may not be used.
- E. Lifesaving equipment in good repair shall be ready for immediate use by response personnel. A flotation device is recommended, such as a rescue tube, bodyboard, or life jacket, supplemented, as appropriate, by reaching and throwing devices and small craft. Dive boats should be equipped with radios and first aid kits, and should deploy a safety line.



5. **Response Personnel (lifeguards and lookout)**

It is the responsibility of the qualified supervisor to designate personnel for emergency response whenever lifeguards are not provided by a facility or tour operator. The snorkeling party should be divided into groups of two to eight swimmers with two responders, paired as buddies, assigned to each group. (Units may be divided by patrols or crews.) The responders should be competent swimmers with basic water-rescue skills. Emergency procedures, including entries, exits, and the role of everyone in the group, should be reviewed and practiced before the activity using rescue aids at the site. The responders should be stationed either afloat or ashore where they can see and hear all those in their group. Neither the responders nor the swimmers should face into the sun to see the other. Snorkelers in a group should remain off the same side of a vessel. Inflatable or rigid dinghies with oars are appropriate response craft. The responders and snorkelers should remain close enough for rapid rescue, generally within 50 feet of one another. In some situations, the qualified supervisor may deem it appropriate for the responders to tow rescue aids while accompanying their group in the water.

Responders are responsible for surveillance as well as rescue. If there is more than one group, then a separate lookout, who may be the qualified supervisor, should coordinate the entire activity and monitor changing conditions. The lookout should have audible or visible means, such as an air horn or flag, to recall all groups. If a boat is used to transport snorkelers to the site, then at least one person should remain aboard who knows how to drive the boat and use the radio. A least one person in the party must be trained in CPR.

It is the combined responsibility of the adult supervisor, the lookout, and the responders to know the number of people in the water at all times and to make frequent visible confirmations of that number. Buddy boards and tags, or their equivalent, must be used to account for everyone in the water.

6. **Ability**



Only those who have completed the Snorkeling BSA requirements may participate in open-water snorkeling. Scouts classified as beginners or nonswimmers may use snorkeling equipment in clear, confined water

of appropriate depth, as specified in Safe Swim Defense (points 3 and 6), during instructional swims or during closely supervised recreational activity. Training for the Snorkeling BSA award is limited to Scouts and adults classified as swimmers.

7. **Buddy System**



All participants in snorkeling activities are paired as buddies. Buddies should check each other's equipment prior to the activity and review hand signals. During the activity, they remain close enough that they are

constantly aware of their buddy's location and condition. Generally, buddies should take turns making breath-holding dives. That is, one buddy remains at the surface, floating with his mask in the water while breathing through the snorkel, and keeps an eye on the buddy who is down. When the diver surfaces, both buddies check their position relative to the group before moving on or letting the other buddy dive.

The adult supervisor, lookout, or responders may call buddy checks as needed to keep the buddies together. Buddy checks may also be called to aid communication. Buddy pairs should be instructed to routinely watch for predetermined audible and visual signals of a buddy check.

8. Discipline



Be sure everyone understands and agrees that snorkeling is allowed only with proper supervision and use of the complete Safe Swim Defense and BSA Snorkeling Safety standards. The appli-

cable rules should be presented and learned before the outing, and should be reviewed for all participants at the beginning of the snorkeling activity. Scouts should respect and follow all directions and rules of the adult supervisor. When people know the reason for rules and procedures, they are more likely to follow them. Treatment should be strict and fair, without favoritism.

Scuba

Swimming underwater using a compressed air source involves the use of sophisticated equipment. Simple actions, such as holding the breath, can be hazardous. Despite such complications, scuba activities as a whole have an excellent safety record. That record can be attributed to quality training programs adopted by the industry. Scouting relies on such training to provide safe scuba opportunities for its members.



Scuba training has several levels. Basic introductory experiences are conducted in pools with a small number of participants supervised by a certified instructor. Those completing such courses are given a taste of the sport under controlled conditions

but are not prepared to dive on their own. Scuba BSA for qualified Scouts, Scouters, and Venturers is such a program. Requirements are found in the Scuba BSA brochure, No. 430-515, which is also available online at www.scouting.org.

Slightly more advanced introductory courses conclude with an open-water dive under close supervision. Open-water dives are not an option for Scuba BSA.

Open-water certification courses provide the training needed for independent diving with a buddy and are normally required before a person is allowed to fill or rent



tanks. Numerous tour operators and dive shops arrange group dive trips for people so certified. Standard open-water certification is offered only to those over a certain age. Junior diver certification is available for those below that age. Boy Scouts

may obtain open-water certification as part of the Scuba Diving merit badge. Venturing groups may participate in scuba certification programs, appropriate to their age and current level of certification, that are conducted by recognized agencies.

Many recreational specialty courses are available to those with open-water certification. These include underwater photography, wreck diving, cave diving, cold-water diving, and diver rescue. Divers with a sufficient number of logged dives and additional training may qualify for a *divemaster* rating. Divemaster is the minimum qualification needed by the dive supervisor when certified divers engage in unit dives during Scouting activities.

All scuba instruction must be conducted by certified scuba instructors. Units that are interested in scuba training can find Scout camps that offer training programs under the high-adventure listing on the BSA website: www.scouting.org. The Florida National High Adventure Sea Base, www.bsaseabase.org, offers scuba training and dive programs. Training may also be arranged through local PADI, NAUI, SSI, IDEA, PDIC, or SDI dive shops. The use of other dive training agencies is authorized under conditions found in the complete BSA scuba policy statement that follows.

Scuba certification requires a level of preparation for underwater diving that the BSA seeks for surface swimming via Safe Swim Defense and skill instruction. Every certified scuba diver has the knowledge, skills, and experience to recognize and minimize environmental risks, to move safely through the water, and to aid a buddy in distress. Drownings during recreational swimming would all but disappear if every member of the swimming public knew and observed basic safety rules, could swim well, and knew simple rescue techniques for themselves and others.

BSA Scuba Policy

The BSA scuba policy recognizes scuba industry standards and implements them by using outside agencies for training and certification.

Training and Supervision

Any person possessing, displaying, or using scuba (self-contained underwater breathing apparatus) in connection with any Scouting-related activity must be either currently certified by a recognized agency or enrolled in an instructional scuba program, such as Scuba BSA or the Scuba Diving merit badge, which must be conducted by an insured recreational diving instructor in good standing with a recognized agency and approved by the council.

Recreational diving activities by BSA groups must be supervised by a responsible adult currently certified (renewed) as a divemaster, assistant instructor, or higher rating from a recognized agency. Dive environments, equipment, depths, procedures, supervision, and buddy assignments must be consistent with each individual's certification.

Because dives by recreational divers may be infrequent, the divemaster or instructor supervising a BSA scuba activity should screen participants prior to open-water activities and provide remedial instruction and practice as appropriate. Such remedial instruction and practice should be in accordance with the policies and standards of the divemaster's or instructor's agency for Scuba Review, Scuba Refresher, or similar program.

Diving using surface-supplied air systems is not authorized in connection with any BSA activity or facility except when done under contract by commercial divers.

Age-Appropriate Restrictions

Youth members in Cub Scouting, including Webelos Scouts, are not authorized to use scuba in any activity.

Boy Scouts may participate in the introductory Scuba BSA program and may obtain open-water certification as part of the Scuba Diving merit badge.

Venturing groups may participate in introductory and certification scuba programs conducted by recognized agencies appropriate to their age and current level of certification.

Standards of the recognized scuba agencies require students for open-water certification programs to be at least 15 years of age but allow special certification programs for younger students. Since all instruction for BSA scuba programs must be conducted by professionals certified by a recognized agency, additional agency-specific, age-related restrictions and protocols apply to students under 15 years of age.

Boy Scouts and Venturers may participate in recreational group dives as unit, district, or council activities, provided such dives are consistent with their certifications and under direct, on-site supervision of a responsible adult currently certified as a divemaster, assistant instructor, or higher rating from a recognized agency.

The divemaster or instructor supervising a recreational dive by a BSA group must implement the following policies for all divers under 15 years of age, as well as any additional junior diver restrictions and protocols adopted by that person's certifying agency:

- Depths are limited to 40 feet for divers under 12 years of age and to 60 feet for divers 12 to 14 years of age.
- Each diver under 15 years of age must have an adult buddy certified as an open-water diver who is either the junior diver's parent or an adult approved by the parent.
- Additional divemasters or instructors are present to maintain a ratio of one trained supervisor to four buddy pairs (eight divers) containing one to four divers under 15 years of age.

Medical Contraindications

Each scuba training agency recognized by the BSA requires a specific health history form prior to enrollment in a certification program. The BSA requires review and approval of the completed form by a physician even if the scuba agency itself does not require physician approval. Various risk factors identified on the forms may exclude a person from scuba training, either temporarily or permanently. Risk factors include, but are not limited to, ear and sinus problems, recent surgery, spontaneous pneumothorax, asthma or reactive airway disease (RAD), seizure disorders, diabetes, leukemia, sickle-cell disorder, pregnancy, panic disorders, and active psychosis.

The divemaster or instructor supervising a BSA recreational scuba activity must review the health information for each

participant that is required annually of all BSA members and evaluate risk conditions using medical standards consistent with those used by his or her certifying agency. Additional tests or physician consultations may be required to confirm fitness for diving. Consultation with medical specialists knowledgeable about diving medicine also may be needed for participants taking psychotropic drugs for treatment of attention deficit disorder, depression, or other conditions.

Scuba diving is prohibited for the following conditions.

- Use of medication to control seizures or seizure occurrence within the past five years
- Use of insulin to control diabetes
- History of asthma or RAD unless resolution confirmed by methacholine testing (Persons who have been asymptomatic and medication free for the previous five years are exempt from the methacholine testing requirements.)

The scuba agencies recognized by the BSA may allow exceptions to general medical prohibitions based on individual diving fitness evaluations by a medical specialist who is knowledgeable about diving medicine. Scouts, parents, dive supervisors, and physicians with questions or concerns about diving with specific medical conditions should consult the Recreational Scuba Training Council (RSTC) Guidelines for Recreational Scuba Diver's Physical Examination and the Divers Alert Network (DAN) at www.diversalertnetwork.org. DAN medical professionals are available for nonemergency consultation by telephone at 919-684-2948 during business hours or via email.

Council Programs

When scuba diving is taught in connection with any local council program, instructors should provide the training on a contract basis. Such instructors should have dive store or other commercial affiliation that provides liability insurance coverage. Direct employment of scuba instructors is not recommended.

Local council programs may not compress or sell air for scuba use, or sell, rent, or loan scuba equipment (scuba cylinders, regulators, gauges, dive computers, weights, or BCDs). All air and equipment for local council program use must be obtained from professional sources (dive stores, resorts, dive boats, etc.) affiliated with a scuba agency recognized by the BSA.



Scuba equipment may be used by certified summer camp aquatics program personnel for installation and maintenance of waterfront equipment, or for search and recovery operations. Search and recovery could include lost equipment, as well as rescue efforts.

Recognized Agencies

Recognized agencies are:

- PADI: Professional Association of Diving Instructors
- NAUI: National Association of Underwater Instructors
- SSI: Scuba Schools International
- IDEA: International Diving Educators Association
- PDIC: Professional Diving Instructors Corporation
- SDI: Scuba Diving International
- YMCA Scuba Program (discontinued in 2008, but certification cards are still recognized)
- NASDS: National Association of Scuba Diving Schools (merged with SSI, but certification cards are still recognized)

In addition to the agencies listed by name, any current member of the World Recreational Scuba Training Council (WRSTC), which includes all RSTC members, is also recognized.

Other agencies wishing to be recognized by the BSA may contact the Outdoor Programs Team of the national office. Recognition by a certifying body such as the RSTC or EUF that the agency adheres to ANSI/CEN/ISO standards would be expected.

Review Questions for Section II

1.0 List the eight points of Safe Swim Defense.

- 1.
- 2.
- 3.
- 4.
- 5.
- 6.
- 7.
- 8.

2.1 Maximum recommended depth for the swimmer area in clear water is

- A. 8 feet
- B. 10 feet
- C. 12 feet
- D. 14 feet

2.2 Beginners should be restricted to water depths

- A. Waist deep
- B. Chest deep
- C. Chin deep
- D. Just over the head

2.3 Nonswimmers should be restricted to water depths no more than

- A. Knee deep
- B. Waist to chest deep
- C. Chin deep
- D. Just over the head

3.1 Water depth for headfirst entry from poolside into clear water must be at least

- A. 5 feet
- B. 7 feet
- C. 9 feet
- D. 11 feet

3.2 Water depth for headfirst entry from a low height (around 3 feet) must be

- A. At least 12 feet in murky water
- B. At least 8 feet in clear water
- C. Consistent with state regulations for diving boards
- D. At least 12 feet in clear water

3.3 Feetfirst entry should be limited to heights no greater than

- A. Knee high
- B. Waist high
- C. Chest high
- D. Head high

4.1 Underwater swimming is prohibited

- A. In water less than 3 feet deep
- B. At night
- C. In murky or turbid water
- D. When water temperature is less than 70°

4.2 Swimming activity must be curtailed when

- A. The sky is overcast
- B. There is intermittent drizzle
- C. There is thunder or lightning
- D. All of these

4.3 Having swimmers wear life jackets should be considered

- A. In clear water over 12 feet deep
- B. In murky water over head height
- C. In weak current
- D. All of these

5.1 A buddy check is conducted

- A. Approximately every 10 minutes
- B. When Scouts are disruptive
- C. During an emergency
- D. For all of these

- 5.2 The *primary* purpose of the buddy check is to**
- Check the number of people in the water
 - Reinforce the buddy concept
 - Signal the end of the period
 - Clear the area in an emergency
- 5.3 During a unit swim, a record of buddies and their ability groups may be kept by**
- Using buddy tags and a portable buddy board
 - Using sticks with printed names
 - Using a written list
 - Any of these
- 6.1 Surveillance (that is, monitoring swimmers for signs of trouble) is the responsibility of**
- The lifeguards
 - The lookout
 - Each buddy
 - All of these
- 6.2 A lookout should be**
- A strong swimmer
 - Provided with rescue equipment
 - Coached in effective surveillance techniques
 - All of these
- 6.3 Rescue personnel (lifeguards) should be**
- Strong swimmers
 - Provided with rescue equipment
 - Coached in appropriate rescue techniques
 - All of these
- 7.1 Generally, headfirst diving is appropriate at**
- Aboveground pools
 - Small backyard pools
 - An ocean beach
 - None of these
- 7.2 Which of these is a possible concern at an aboveground pool?**
- Depth is too shallow for beginner and swimmer areas
 - Water clarity
 - Current
 - The water is too deep for some nonswimmers
- 7.3 Emergency action plans for backyard pools should include**
- A quick, reliable means to summon EMS
 - Use of rescue equipment
 - Means for removing an incapacitated person from the water
 - All of these
- 8.1 Everyone in the unit should be involved in setting up a safe swim area.**
- T F
- 8.2 A lookout is needed even when a small group is setting up a swim area.**
- T F
- 8.3 In turbid water, a single swimmer with a lifeline checks deepwater areas by doing a headfirst surface dive and swimming along the bottom with arms extended.**
- T F
- 9.1 A unit with only beginners and swimmers needs three ability group areas at a temporary lakefront setting.**
- T F
- 9.2 If bottom slopes and depths are less than ideal, ability groups may swim together in an area appropriate for those of the lesser classification.**
- T F
- 9.3 Access to the swimmers area should be through the nonswimmer and beginner areas.**
- T F
- 10.1 At a bend in a river, the deepest water and strongest current is**
- On the inside of the curve
 - Midstream
 - On the outside of the curve
 - Totally unpredictable

- 10.2 The preferred location for a swimming area on a river is often**
- A. On the upstream end of a sandbar on the inside of a bend
 - B. On the protected downstream end of a sandbar on the inside of a bend
 - C. In the deeper water on the outside of a bend
 - D. In an area where the water covers grass rather than mud
- 10.3 Which of the following is a sign that a river is higher than normal?**
- A. Exposed sandbars
 - B. Strainers along the cut bank
 - C. Water flowing over grass
 - D. Debris resting high in trees
- 11.1 Which of the following is a major safety concern at an ocean beach, responsible for more rescues than any other?**
- A. Undertow
 - B. Drift current
 - C. Rip current
 - D. Surf
- 11.2 Which of the following are potential hazards, particularly for nonswimmers?**
- A. Backwash
 - B. Troughs caused by drift currents
 - C. Tidal shelf
 - D. All of the above
- 11.3 Of the following, which is most suitable for swimming?**
- A. Rip currents
 - B. Spilling waves
 - C. Plunging waves
 - D. Surging waves
- 12.1 Which of the following is a reasonable precaution when swimming from a boat in deep water with a slight current?**
- A. Swimmers only
 - B. Wearing a life jacket
 - C. Swimming up-current of a safety line
 - D. All of the above
- 12.2 When swimming from a large boat, rescue personnel may be stationed**
- A. On the vessel
 - B. In a dinghy
 - C. On a paddleboard
 - D. Any of the above as appropriate
- 12.3 Which of the following is not allowed?**
- A. Distance swimming along a protected, closed circuit
 - B. Venturing triathlon training
 - C. Distance swimming in open water accompanied by a lone person in a rowboat
 - D. A and C
- 13.1 For a unit swim at a public pool with professional lifeguards on duty:**
- A. Safe Swim Defense principles don't apply
 - B. Unit rescue personnel need not be deployed
 - C. The buddy system is not used
 - D. All of these
- 13.2 At a location with professional lifeguards, the unit leader is responsible for**
- A. Taking any precautions indicated by medical concerns
 - B. Implementing a buddy system
 - C. Restricting nonswimmers to shallow water
 - D. All of the above
- 13.3 At a location with professional lifeguards, which of the following is not a common expectation of the lifeguards?**
- A. Surveillance for drowning situations
 - B. Implementing emergency action plans, including water rescue
 - C. Administering and enforcing swimmer classifications
 - D. Enforcing rules against diving in shallow water
- 14.1 Ideally, youth should learn basic swimming skills before Boy Scout age, that is, early during Cub Scouting.**
- T F

- 14.2 Ideally, the butterfly should be introduced prior to resting strokes.**
T F
- 14.3 Basic swimming skills are always best taught in a large group by a highly trained professional rather than individually by a knowledgeable parent.**
T F
- 15.1 All conscious drowning victims will call out for help.**
T F
- 15.2 A child apparently playing in deep water could actually be drowning.**
T F
- 15.3 A nonswimmer falling off an air mattress into deep water can generally save himself or herself by lunging for the float.**
T F
- 16.1 A person may lose consciousness and submerge due to**
A. Drowning
B. A heart attack
C. A diving injury
D. All of the above
- 16.2 While speedy rescue is very important in any situation, which of the following is the *most* urgent?**
A. A tired swimmer barely able to stay afloat
B. A distressed swimmer calling for help
C. A submerged victim
D. A swimmer caught in a current
- 16.3 For which type of victim will rescue always involve physical contact?**
A. A tired swimmer
B. A distressed swimmer
C. An actively drowning nonswimmer
D. A passive, submerged victim
- 17.1 A throwing rescue is normally not useful for which types of victims?**
A. Distressed swimmers
B. Endangered swimmers
C. Submerged or spinal injury victims
D. Tired swimmers
- 17.2 The preferred order of methods of rescue is**
A. Wade, row, go
B. Reach, wade, row, go
C. Reach, throw, row, go
D. Extension, tow, carry
- 17.3 A reach pole is swept to a victim from the side to**
A. Prevent the victim from lunging into the end of the pole
B. Bring the pole into physical contact with an active drowning victim
C. A and B
D. None of the above; the pole should be extended directly toward the victim's chest
- 18.1 Which throwing device is generally easier to use effectively?**
A. A ring buoy without a line
B. A ring buoy with line attached
C. A throw bag
D. A heaving line
- 18.2 The preferred way to coil a line is**
A. Wrapping between the hand and elbow
B. Moving both hands apart and together
C. Fixing one hand and moving in and out with the other
D. Laying coils at your feet
- 18.3 When retrieving a ring buoy for a second attempt, the line should be**
A. Coiled as before
B. Dropped loosely at the feet
C. Left floating in the water
D. Wrapped around the buoy

- 19.1 Rowing rescues are easier with two people in separate boats rather than two people in a single boat.**
T F
- 19.2 Conscious victims should be lifted into a rescue boat as soon as possible.**
T F
- 19.3 An effective rowing assist may incorporate reaching and throwing devices.**
T F
- 20.1 Swimming assists are extremely dangerous and are not advocated for unit swim protection.**
T F
- 20.2 There is always an alternative to an in-water rescue.**
T F
- 20.3 Untrained, poor swimmers should avoid in-water rescue attempts.**
T F
- 21.1 A flotation aid is recommended in case an in-water assist is needed.**
T F
- 21.2 The rescuer always grasps the victim during an in-water rescue.**
T F
- 21.3 A long shallow dive is the preferred entry for an in-water rescue.**
T F
- 22.1 During an accompanied rescue, the rescuer releases the flotation aid after shoving it into the victim's grasp because**
A. The victim may have better support
B. The victim will tend to grasp the device rather than the rescuer
C. A tow can still be initiated if needed
D. All of the above
- 22.2 Holding a conscious victim to a flotation aid is not the first choice for an in-water assist since**
A. It is often not necessary
B. It is more complicated
C. The tow is more strenuous
D. All of the above
- 22.3 A contact assist is needed when the victim cannot grasp a flotation aid due to**
A. Unconsciousness
B. A stroke or other debilitating condition
C. Numbness due to cold
D. Any of the above, plus others
- 23.1 Various contact assists without flotation aids are options for unconscious victims when**
A. The person must be recovered from underwater
B. The flotation aid is not well suited to the situation
C. Positioning the flotation aid would unduly delay the rescue
D. All of the above
- 23.2 The wrist tow may be used**
A. From a different approach
B. When the victim is conscious, but passive
C. As a tow in rough water
D. All of the above
- 23.3 The wrist tow may be used**
A. From a front approach
B. To place the victim across a flotation device
C. For unconscious victims without spinal injury
D. All of the above
- 24.1 Prompt medical attention is needed for all submerged victims who may have aspirated water.**
T F
- 24.2 If a swimmer is missing in deep, turbid water, all members of the unit should quickly begin a random search of the bottom.**
T F

- 24.3 Required life jacket use is a reasonable precaution in deep, turbid water if the unit is poorly prepared to conduct an organized underwater search.**
T F
- 25.1 A spinal injury should be suspected when**
A. A person's head strikes anything but the water
B. A person complains of neck pain
C. One person lands on another
D. Any of the above
- 25.2 If a spinal injury is indicated for a passive, face-down person, first**
A. Check for breathing and circulation
B. Ask the person to gently roll his head
C. Ask if the person has numbness in the limbs
D. Use in-line stabilization to turn the person face up and summon EMS
- 25.3 In-line stabilization using head and chin support may not be appropriate when the victim is**
A. Faceup in shallow water
B. Facedown in shallow water
C. Faceup in deep water
D. Facedown in deep water
- 26.1 The line-and-tender procedure requires two swimmers, a line, and a life jacket.**
T F
- 26.2 The line-and-tender procedure requires minimal equipment and training.**
T F
- 26.3 The line-and-tender procedure should be familiar to many Boy Scouts since it is included in rank advancement.**
T F
- 27.1 The preventive elements of Safe Swim Defense minimize the need for rescues.**
T F
- 27.2 The preventive elements of Safe Swim Defense eliminate the need for rescues.**
T F
- 27.3 In urban settings, quick EMS response is sufficient preparation for emergencies.**
T F
- 28.1 Essential elements in unit swim protection include**
A. Continuous, effective monitoring of everyone
B. Persons trained in rescue procedures
C. An emergency action plan, including communication with EMS
D. All of the above
- 28.2 Swimmers are continuously surveyed by**
A. The buddy
B. The lookout
C. Response personnel (lifeguards)
D. All of the above
- 28.3 For large groups, surveillance areas assigned the safety team should be**
A. Redundant total coverage by all personnel
B. Individual zones with slight overlap
C. Individual zones with total overlap
D. Total coverage combined with overlapping zones
- 29.1 Response personnel are generally best deployed as**
A. Individuals watching separate zones
B. Individuals whose scans include responders in adjacent zones
C. Buddy pairs watching the same area and each other
D. Buddy pairs watching separate zones
- 29.2 During a rescue, the rescuer's buddy**
A. Stands by to assist
B. Provides backup surveillance of the rescuer's assigned zone
C. Helps the lookout clear the area
D. Reacts according to the emergency action plan

- 29.3 Which of the following are inappropriate functions of safety team members on duty?**
- A. Continuous surveillance of assigned areas
 - B. Intervening to stop rule infractions or to provide emergency aid
 - C. Refereeing a game or assisting a person with a skill
 - D. Providing backup surveillance and supervision of swimmers not involved in a rescue situation

- 30.1 Snorkeling Safety extends Safe Swim Defense guidelines by adding which of the following?**
- A. Consideration of equipment
 - B. Limitations on water clarity for training
 - C. Training requirements for open-water snorkeling
 - D. All of the above

- 30.2 The instructor for Scuba BSA must have council approval and have current certification by a recognized agency as**
- A. Open-water diver
 - B. Divemaster
 - C. Scuba instructor
 - D. Any of the above

- 30.3 Which of the following is appropriate for both snorkeling and scuba?**
- A. Monitoring time underwater to prevent the bends
 - B. Equalizing pressure in the ears
 - C. Continuous breathing while underwater
 - D. All of the above

Boating Skills and Safety

Section





Safety Afloat

All boating activities in Scouting are required to follow the nine basic principles known collectively as Safety Afloat. During the 1970s, public interest in river canoeing experienced a huge surge in popularity with a corresponding increase in the number of fatalities. Scouting's response was to devise a set of safety guidelines for float trips based on the successful Safe Swim Defense plan. The emphasis is on accident prevention through proper preparation and skill. A unit that follows Safety Afloat can expect a safe, enjoyable experience.

A summary of Safety Afloat appears in Chapter 3. The complete text is given here in bold type with additional explanatory material in regular print.



- 1. Qualified Supervision.** All activity afloat must be supervised by a mature and conscientious adult age 21 or older who understands and knowingly accepts responsibility for the well-being and safety of those in his or her care, and who is trained and committed to compliance with the nine points of BSA Safety Afloat. That supervisor must be skilled in the safe operation of the craft, knowledgeable in accident prevention, and prepared for emergency situations. Additional leadership is provided in ratios of 1 to 5 for Cub Scouts and 1 to 10 for Boy Scouts and Venturers. At least one leader must be trained in CPR. It is strongly recommended that all units have at least one member trained in BSA Paddle Craft Safety to assist in activity afloat.
- 2. Personal Health Review.** Adjust supervision to anticipate any potential risks identified by review of required health histories.
- 3. Swimming Ability.** Operation of any boat is limited to those who have completed the BSA swimmer classification test. Those not classified as swimmers may ride as passengers on calm water when there is little chance of capsizing or falling overboard.
- 4. Personal Flotation Equipment.** Approved, properly fitted PFDs must be worn by all persons engaged in boating activity.

BSA groups shall use Safety Afloat for all boating activities. Adult leaders supervising activities afloat must have completed Safety Afloat training within the previous two years. Cub Scout activities afloat are limited to council, district, pack, or den events that do not include moving water or float trips (expeditions).

Safety Afloat standards apply to the use of canoes, kayaks, rowboats, rafts, floating tubes, sailboats, motorboats (including waterskiing), and other small craft, but do not apply to transportation on large commercial vessels such as ferries and cruise ships. Parasailing (being towed airborne behind a boat using a parachute), kitesurfing (using a wakeboard towed by a kite), and unit-level recreational use of personal watercraft (small sit-on-top motorboats propelled by water jets) are not authorized BSA activities.

Safety Afloat training may be obtained from my.scouting.org, at council summer camps, and at other council and district training events. Additional guidance on appropriate skill levels and training resources is provided in the *Aquatics Supervision* guide available from council service centers.

1. Qualified Supervision

All activity afloat must be supervised by a mature and conscientious adult age 21 or older who understands and knowingly accepts responsibility for the well-being and safety of those in his or her care and who is trained in and committed to compliance with the nine points of BSA Safety Afloat. That supervisor must be skilled in the safe operation of the craft for the specific activity, knowledgeable in accident prevention, and prepared for emergency situations. If the adult with Safety Afloat training lacks the necessary boat operating and safety skills, he or she may serve as the supervisor only if assisted by other adults, camp staff personnel, or professional tour guides who have the appropriate skills. Additional leadership is provided in ratios of one trained adult, staff member, or guide per 10 participants. For Cub Scouts, the leadership ratio is one trained adult, staff member, or guide per five participants. At least one leader must be

trained in first aid including CPR. Any swimming done in conjunction with the activity afloat must be supervised in accordance with BSA Safe Swim Defense standards. It is strongly recommended that all units have at least one adult or older youth member currently trained in BSA Aquatics Supervision: Paddle Craft Safety to assist in the planning and conduct of all activities afloat.

The purpose of this publication is to provide the unit leader with sufficient information to confidently know when he or she meets the expectations set forth in the first point. This book also serves as the text for training in BSA Paddle Craft Safety.

2. Personal Health Review

A complete health history is required of all participants as evidence of fitness for boating activities. Forms for minors must be signed by a parent or legal guardian. Participants should be asked to relate any recent incidents of illness or injury just prior to the activity. Supervision and protection should be adjusted to anticipate any potential risks associated with individual health conditions. For significant health conditions, the adult supervisor should require an examination by a physician and consult with parent, guardian, or caregiver for appropriate precautions.

This important item is shared with Safe Swim Defense and was covered in Chapter 4.

3. Swimming Ability

Operation of any boat on a float trip is limited to youth and adults who have completed the BSA swimmer classification test. Swimmers must complete the following test, which should be administered annually:

Jump feetfirst into water over the head in depth. Level off and swim 75 yards in a strong manner using one or more of the following strokes: sidestroke, breaststroke, trudgen, or crawl; then swim 25 yards using an easy, resting backstroke. The 100 yards must be completed in one swim without stops and must include at least one sharp turn. After completing the swim, rest by floating.

For activity afloat, those not classified as a swimmer are limited to multiperson craft during outings or float trips on calm water with little likelihood of capsizing or falling overboard. They may operate a fixed-seat rowboat or pedal boat accompanied by a buddy who is a swimmer. They may paddle or ride in a canoe or other paddle craft with an adult swimmer skilled in that craft as a buddy. They may ride as part of a group on a motorboat or sailboat operated by a skilled adult.

Note that this directive allows flexibility for those with poor swimming skills to participate, primarily as passengers, in various situations. However, only swimmers may participate in whitewater activities.

4. Life Jackets

Properly fitted U.S. Coast Guard–approved life jackets must be worn by all persons engaged in boating activity (rowing, canoeing, sailing, boardsailing, motorboating, waterskiing, rafting, tubing, and kayaking). Type III life jackets are recommended for general recreational use.

For vessels over 20 feet in length, life jackets need not be worn when participants are below deck or on deck when the qualified supervisor aboard the vessel determines that it is prudent to abide by less-restrictive state and federal regulations concerning the use and storage of life jackets, for example, when a cruising vessel with safety rails is at anchor. All participants not classified as swimmers must wear a life jacket when on deck under way.

Life jackets need not be worn when an activity falls under Safe Swim Defense guidelines—for example, when an inflated raft is used in a pool or when snorkeling from an anchored craft.

Life jackets with tears and inoperable buckles do not meet Coast Guard standards. Proper fit, including correct sizing and fastening, is just as important as Coast Guard approval. The next chapter provides additional information on life jacket selection, fit, and use.

5. Buddy System

All participants in an activity afloat are paired as buddies who are always aware of each other’s situation and prepared to sound an alarm and lend assistance immediately when needed. When several craft are used on a float trip, each boat on the water should have a “buddy boat.” All buddy pairs must be accounted for at regular intervals during the activity and checked off the water by the qualified supervisor at the conclusion of the activity. **Buddies either ride in the same boat or stay near one another in single-person craft.**

Buddy tags and boards are often used at BSA summer camps where boating is done in a limited area with the same launch and landing site. That specific tracking system is not required for a unit float trip, but the unit leader must have an unambiguous means to ensure that everyone who ventures on the water also gets off the water when expected.

6. Skill Proficiency

Everyone in an activity afloat must have sufficient knowledge and skill to participate safely. Passengers should know how their movement affects boat stability and have a basic understanding of self-rescue. Boat operators must meet government requirements, be able to maintain control of their craft, know how changes in the environment influence that control, and undertake activities only that are within their personal and group capabilities.

- Content of training exercises should be appropriate for the age, size, and experience of the participants, and should cover basic skills on calm water of limited extent before proceeding to advanced skills involving current, waves, high winds, or extended distance. At a minimum, instructors for canoes and kayaks should be able to demonstrate the handling and rescue skills required for BSA Aquatics Supervision: Paddle Craft Safety. All instructors must have at least one assistant who can recognize and respond appropriately if the instructor’s safety is compromised.
- Anyone engaged in recreational boating using human-powered craft on flat-water ponds or controlled lake areas free of conflicting activities should be instructed in basic safety procedures prior to launch, and allowed to proceed after they have demonstrated the ability to control the boat adequately to return to shore at will.

- **For recreational sailing, at least one person aboard should be able to demonstrate basic sailing proficiency (tacking, reaching, and running) sufficient to return the boat to the launch point. Extended cruising on a large sailboat requires either a professional captain or an adult with sufficient experience to qualify as a bareboat skipper.**
- **Motorboats may be operated by youth, subject to state requirements, only when accompanied in the boat by an experienced leader or camp staff member who meets state requirements for motorboat operation. Extended cruising on a large powerboat requires either a professional captain or an adult with similar qualifications.**
- **Before a unit using human-powered craft controlled by youth embarks on a float trip or excursion that covers an extended distance or lasts longer than four hours, each participant should receive either a minimum of three hours' training and supervised practice or demonstrate proficiency in maneuvering the craft effectively over a 100-yard course and recovering from a capsize.**
- **Self-guided unit trips on Class III white water may only be done after all participants have received American Canoe Association or equivalent training for the class of water and type of craft involved. Unit trips on whitewater sections of rivers rated Class IV are only allowed in rafts with a professionally trained guide in each raft. Trips above Class IV are not allowed.**

Skill is an important component for an enjoyable, safe activity afloat. Because skills must be learned, Safety Afloat provides for novice participation in a controlled,

safe teaching environment with progressively more skill expected as the participant moves to independent control of the craft in a remote setting. The specific skills required for different craft in various situations are too diverse to detail in a general policy statement. Instead, Safety Afloat depends on unit leadership's prior awareness of skill levels appropriate for an activity. Leaders without that awareness must recruit experienced assistants with such knowledge to supervise an event afloat.

7. Planning

Proper planning is necessary to ensure a safe, enjoyable exercise afloat. All plans should include a scheduled itinerary, notification of appropriate parties, communication arrangements, contingencies in case of foul weather or equipment failure, and emergency response options.

- **Preparation.** Any boating activity requires access to the proper equipment and transportation of gear and participants to the site. Determine what state and local regulations are applicable. Get permission to use or cross private property. Determine whether personal resources will be used or whether outfitters will supply equipment, food, and shuttle services. Lists of group and personal equipment and supplies must be compiled and checked. Even short trips require selecting a route, checking water levels, and determining alternative pull-out locations. Changes in water level, especially on moving water, may pose significant, variable safety concerns. Obtain current charts and



information about the waterway and consult those who have traveled the route recently.

- **Float Plan.** Complete the preparation by writing a detailed itinerary, or float plan, noting put-in and pull-out locations and waypoints, along with the approximate time the group should arrive at each. Travel time should be estimated generously.
- **Notification.** File the float plan with parents, the local council office if traveling on running water, and local authorities if appropriate. Assign a member of the unit committee to alert authorities if prearranged check-ins are overdue. Make sure everyone is promptly notified when the trip is concluded.
- **Weather.** Check the weather forecast just before setting out, and keep an alert weather eye. Anticipate changes and bring all craft ashore when rough weather threatens. Wait at least 30 minutes before resuming activities after the last incidence of thunder or lightning.
- **Contingencies.** Planning must identify possible emergencies and other circumstances that could force a change of plans. Develop alternative plans for each situation. Identify local emergency resources such as EMS systems, sheriff's departments, or ranger stations. Check your primary communication system, and identify backups, such as the nearest residence to a campsite. Cell phones and radios may lose coverage, run out of power, or suffer water damage.

This item reinforces the Scout motto: Be Prepared.



8. Equipment

All craft must be suitable for the activity, seaworthy, and float if capsized. All craft and equipment must meet regulatory standards, be properly sized, and be in good repair. Spares, repair materials, and emergency gear must be carried as appropriate. Life jackets and paddles must be sized to the participants. Properly designed and fitted helmets must be worn when running rapids rated Class II and above. Emergency equipment such as throw bags, signal devices, flashlights, heat sources, first aid kits, radios, and maps must be ready for use. Spare equipment, repair materials, extra food and water, and dry clothes should be appropriate for the activity. All gear should be stowed to prevent loss and water damage.



For float trips with multiple craft, the number of craft should be sufficient to carry the party if a boat is disabled, and critical supplies should be divided among the craft.

Proper equipment depends on the kind of craft as well as the type and duration of the activity. Someone who has conducted a similar activity should be a valuable resource—experience is hard to beat.

9. Discipline

Rules are effective only when followed. All participants should know, understand, and respect the rules and procedures for safe boating activities provided by Safety Afloat guidelines. Applicable rules should be discussed prior to the outing and reviewed for all participants near the boarding area just before the activity afloat begins. People are more likely to follow directions when they know the reasons for rules and procedures. Consistent, impartially applied rules supported by skill and good judgment provide stepping stones to a safe, enjoyable outing.

Like the bread that holds together a sandwich, discipline and qualified supervision are the foundation and cover that make safe Scouting a reality. Scouts are accustomed to following rules in other situations and will likely also be well-behaved during boating events. That is particularly true if the Scouts are reminded of their dual responsibility for their own safety and that of others in the unit. Youth leaders should share in decisions and guidance. However, youthful exuberance may at times cause momentary lapses in attention. That is, fun and a sense of adventure can overwhelm common sense. Dealing with such situations is a learning experience for youth and leaders, but leaders should realize that youngsters cannot always be expected to act rationally in the interest of their own safety. Adult leaders should therefore accept that they, not the Scouts, are ultimately responsible for implementing BSA rules and procedures.





Life Jackets

State regulations often mandate life jacket use. Where state laws do not exist, federal law requires that children under the age of 13 wear a life jacket on a recreational boat unless the child is below deck, in an enclosed cabin, or if the boat is not under way. An appropriate, easily accessible life jacket must be carried for all adults, including those towed behind the craft. BSA policy is more stringent: **Properly fitted U.S. Coast Guard–approved life jackets must be worn by all persons engaged in boating activity.**



Designs

Life jackets are divided into five categories. Types I, II, III, and V are worn. Type IV indicates a throwing device.

Type I—Offshore Life Jacket

These life jackets are generally used as emergency devices on commercial vessels. They are effective for all waters, especially open, rough, or remote waters where rescue may be delayed. They will turn most unconscious people faceup. The inherently buoyant styles are generally too bulky for recreational activities. Inflatable and hybrid styles are available. Hybrid styles combine fixed flotation material with air inflation.



Type II—Nearshore Buoyant Vest

These life jackets will turn some unconscious persons faceup. They are intended for calm, inland water, or where the chance of quick rescue is good. The familiar horse-collar styles are generally less expensive than any other type. However, they often are uncomfortable for extended wear and may interfere with some recreational activities. Inflatable and hybrid styles are available but are expensive. Some Type II life jackets designed for small children are appropriate flotation devices for swimming activities as well as boating. Note the crotch strap and handle on the child version.

Type III—Flotation Aid

These life jackets are designed to help wearers achieve and maintain a faceup position in the water. They come in a wide variety of comfortable styles that allow a good range of motion. They are generally best for recreational use. Prices vary from economical to expensive.



Type V—Special-Use Device

The various special-use life jackets are designed for the specific industrial and recreational situations indicated on their labels. Some are multipurpose; that is, a jacket labeled Type V for whitewater use may also serve as a Type III for other uses.

Inflatable and hybrid life jackets may be found in any of the wearable categories. Inflatable devices must be worn to qualify for Coast Guard approval, and are not authorized for use for those less than 16 years of age. That limits their use in Scouting.

Type IV—Throwable Devices

These personal flotation devices may be thrown to boaters in need. They are to be grasped by a swimmer, not worn. In addition to a wearable life jacket for everyone aboard, federal requirements mandate a Type IV throwable device on any boat 16 feet or longer except canoes, kayaks, and rowing shells.

Size



Life jackets come in Adult, Youth, Child, and Infant sizes. Check the life jacket label for the appropriate weight range. **Note:** A life jacket whose label is illegible is no longer Coast Guard–approved.





Fit

A life jacket must be worn with all straps and zippers properly fastened. Pull adjustable straps until the life jacket fits snugly, but comfortably, over clothing worn for different weather conditions. A properly fitted life jacket will not ride up around the head when lifted by the shoulder straps or supporting a person in the water. If it does, a smaller size is needed. Simply tightening the straps on an adult life jacket will not make it safe for a child.

Condition

Sun exposure can weaken life jacket materials.

If strap attachments are torn, buckles are inoperable, or foam material is exposed, the life jacket or flotation aid is no longer safe, nor approved. Destroy it to prevent use.



Dynamic Strength Testing

Life jackets designed for waterskiing and other situations where impact with the water is likely are reinforced, typically with three straps that circle the vest. Check the label to see that the life jacket is rated for those activities. Inflatables are not. **Note:** A life jacket with a strength rating does not mean that the life jacket protects the wearer from injury.

1 FLOTATION AID—TYPE III PFD
1 INTENDED USE: KAYAKING & SAILING VEST
 SIZE: YOUTH

USER WEIGHT: 50–90 lbs (23–41 Kg) **2** CHEST SIZE 26–29 inches
 MODEL: MMM (66–74 CM) **3**
 U.S. COAST GUARD APPROVAL NUMBER 000.000/0000/0 **3**

USCG-approved wearable device for uninspected commercial vessels less than 40 feet (12m) in length not carrying passengers for hire, and for recreational boats. NOT APPROVED FOR USE ON PERSONAL WATER CRAFT, FOR WATER SKIING, OR SIMILAR TOWED USES. **4**

WARNING—TO REDUCE RISK OF DEATH BY DROWNING:

- READ MANUFACTURER’S “THINK SAFE” PAMPHLET BEFORE USING THIS DEVICE AND PERFORM “THINK SAFE” CHECKS EACH SEASON
- CHOOSE THE RIGHT TYPE AND SIZE PFD AND WEAR IT—FASTEN ALL CLOSURES AND ADJUST FOR SNUG FIT
- FOLLOW MANUFACTURER’S USE AND CARE INSTRUCTIONS
- DO NOT CARRY HEAVY OBJECTS—HEAVY OBJECTS IMPAIR FLOTATION

STRENGTH TESTED AT 50 MPH (22.4M/S)—NOT TESTED FOR **5**
 PERSONAL PROTECTION FROM IMPACT

 COMPANY NAME
 STREET
 CITY, STATE

 **6** LISTED FLOTATION AID
 ISSUE NO. A-111

LOT NO. 1 2 3 4 5

WARNING—DO NOT DRY CLEAN
 THIS DEVICE IS NOT TO BE FASTENED TO THE BOAT

MODEL 000W WHITEWATER VEST **1**

ADULT
LARGE/X-LARGE

FOR PERSONS WEIGHING MORE THAN 90 POUNDS. **2**
 CHEST SIZE 42–52 INCHES

TYPE III PERSONAL FLOTATION DEVICE **3**
 U.S. COAST GUARD APPROVAL NO. 000.000/000/0
 APPROVED FOR USE ON ALL RECREATIONAL BOATS AND ON UNINSPECTED COMMERCIAL VESSELS LESS THAN 40 FEET IN LENGTH NOT CARRYING PASSENGERS FOR HIRE BY PERSONS WEIGHING MORE THAN 90 POUNDS. INSPECTED AND TESTED IN ACCORDANCE WITH U.S. COAST GUARD REGULATIONS. **4**
 PVC FOAM BUOYANT MATERIAL PROVIDES A MINIMUM BUOYANT FORCE OF 22 POUNDS.

TYPE V PERSONAL FLOTATION DEVICE
 U.S. COAST GUARD APPROVAL NO. 111.111/111/1
 APPROVED ONLY FOR USE BY PERSONS ENGAGED IN COMMERCIAL WHITEWATER SERVICE WITHIN THE U.S.A.
 THIS IS A TYPE V PFD BECAUSE IT HAS RESTRICTED USCG APPROVAL ALLOWING IT TO BE USED IN PLACE OF A TYPE I PFD ONLY IN COMMERCIAL WHITEWATER ACTIVITIES. WHEN WORN, IT OFFERS SPECIAL PROTECTION TO THOSE PARTICIPATING IN THESE ACTIVITIES AND, THEREFORE, MUST BE WORN AT ALL TIMES IN ORDER TO BE ACCEPTED FOR MEETING THE U.S. COAST GUARD REGULATIONS REQUIRING PFD’S TO BE CARRIED.

NOTICE: BEFORE BOARDING, PUT THIS JACKET ON AND ADJUST TO FIT PROPERLY.

WARNING! DO NOT DRY CLEAN

THERE IS A POTENTIAL FOR BUOYANCY LOSS, DEPENDING ON HOW THIS DEVICE IS USED AND CARED FOR. THE IN-WATER PERFORMANCE OF THIS DEVICE SHOULD BE TESTED AT THE BEGINNING OF EACH SEASON TO DETERMINE THAT IT PROVIDES ADEQUATE PERSONAL FLOTATION.

IMPACT TESTED AT 50 MPH FOR STRENGTH. **5**
 NOT TESTED FOR PERSONAL PROTECTION FROM IMPACT.

TO TIGHTEN ADJUSTMENTS
 PUT VEST ON AND SNAP FRONT BUCKLES.
 GRASP STRAP ON FRONT AND LEFT SIDES
 AND PULL FORWARD SIMULTANEOUSLY
 UNTIL SNUG.

 **6** LISTED COMMERCIAL
 WHITEWATER DEVICE
 ISSUE NO. A-111

LOT NUMBER
 A. 1 2 3 4 5

COMPANY NAME, CITY, STATE. MADE IN U.S.A.

- 1** Intended use statement.
- 2** Size. Based primarily on weight, but chest size also given.
- 3** USCG approval number. Must be legible. Note that one life jacket label has two numbers, one for each use.
- 4** Approved use. Both life jackets are approved as Type III for recreational use. One is also designated as a Type V for use on commercial whitewater trips in lieu of a Type I. It must be worn for that use.
- 5** Impact testing for structural integrity of materials and construction. Life jackets designed for use on personal watercraft, waterskiing, or similar towed uses must have three front closures, two of which encircle the body.
- 6** The USCG sanctions tests conducted by Underwriters Laboratories, which in turn controls content of the label following government regulations.

Both labels also contain other required items such as manufacturer information, lot numbers, and a warning against dry cleaning, along with general safety information that varies depending on the manufacturer.

Years ago, the U.S. Coast Guard adopted the generic designation “personal floatation device” in lieu of older terms such as “life jacket,” “life vest,” or “life preserver.” The PFD acronym was generally recognized by the paddling community, but not necessarily by the public at large. The Coast Guard Office of Boating Safety and the National Safe Boating Council have phased out “PFD” in favor of “life jacket” in safety literature. “PFD” still appears in various regulations.

Statistics

According to an American Canoe Association brochure, **victims in 85 percent of canoeing fatalities and 48 percent of kayaking fatalities were not wearing a life jacket.**



***Wear a life jacket:
It's policy and it's the SMART thing to do!***





Cold-Water Survival

Be Prepared

COLD WATER CAN KILL. Water sucks heat from your body 30 times faster than air. If your core body temperature drops just 3.5 degrees you will experience hypothermia, which can be deadly. Water that is even slightly below your core body temperature of 98.6 degrees Fahrenheit can be dangerous. Your survival time greatly depends on the temperature of the water, your physical condition, and your personal preparation. In water near freezing, an unprotected swimmer may be physically impaired almost immediately and may die in as little as 15 minutes unless removed from the water and properly treated.

Cold Shock is a dangerous, sometimes fatal, condition that can result when a person is suddenly immersed in cold water, such as would occur in a capsized boat. The sudden exposure of the head and chest to cold water typically causes an involuntary gasp for air, sudden increases in heart rate and blood pressure, and disorientation, and can possibly cause cardiac arrest.

Hypothermia results when the body can no longer maintain its normal temperature. In an attempt to protect the core (heart, lungs, and brain), the body systematically begins to shut down. Judgment and coordination are adversely affected. Eventually, death can result. One of the best indicators that someone is becoming hypothermic is if they begin to shiver uncontrollably while at rest. Being at rest is an important factor because the body heat produced by the exercise of paddling tends to temporarily mask the onset of hypothermia. Take frequent breaks where everyone stops exercising and use this time to check whether anyone is shivering.

Prevent

Plan your trip:

- Know the water temperature before you set out.
- Always wear your life jacket.
- Paddle near to shore and/or near others who can help you in the event of capsizing.
- Paddle with others and ensure that all participants know the signs and symptoms of hypothermia.

Fuel your body:

- Keep your body well fueled with high-carbohydrate foods and lots of water.
- Remember, your body expends calories to maintain your core temperature as well as to provide energy to your muscles.

Insulate your body:

- Avoid wearing cotton clothing when paddling in cool temperatures.
- Dress in layers using synthetic fabrics such as polyester fleece to prevent getting overheated or chilled from perspiration.
- Carry a waterproof jacket designed for splash and/or rain protection.

- Anytime the water temperature is less than 60 degrees Fahrenheit, wear specialized insulating clothing capable of protecting you while in the water.
- You should always wear a wet suit or dry suit:
 1. If the air temperature and water temperature combined is less than 120 degrees,
 2. If you will be far from shore in cold water, or
 3. Anytime in cool or mild weather when you expect to be repeatedly exposed to cold water.



Paddle jacket with flotation device

Dry suit

Keep in mind that the warmth and comfort range of a dry suit can be flexible based on the clothing worn underneath it. Some people wear clothes underneath their wet suits, but this defeats the insulating ability of the wet suit, which is to create a microclimate of water next to the skin. Studies have shown that the number one criterion in determining the insulating capability of a wet suit is its ability to trap the water. Wearing clothes beneath your wet suit allows a lot of water movement and, hence, heat loss.

- Wear a warm hat that will stay on your head in the water. A fleece-lined skullcap is ideal.
- Have spare, dry clothing and store in a sealed dry bag while on the water.
- Test your protective clothing in a controlled cold-water environment to understand the level of protection provided.

Watch your group:

- Know your emotional and physical limitations. Group members need to constantly assess the behavior of others in their group. Look for changes in behavior: withdrawal, sluggishness, talking less, or a member not eating enough. These are all symptoms of fatigue and may suggest a problem that the group needs to address.

Assess

The most typical symptoms of hypothermia in general order of onset are:

1. **Shivering**
2. **Impaired judgment**
3. **Clumsiness**
4. **Loss of dexterity**
5. **Slurred speech**
6. **Inward behavior** (withdrawal, apathy, lethargy)
7. **Shivering stops**
8. **Muscle rigidity**
9. **Unconsciousness**
10. **Death**

Treat

Mild hypothermia

(victim shivering but coherent):

Move victim to place of warmth. Remove wet clothes; give warm, sweet drinks, no alcohol or caffeine. Keep victim warm for several hours. The “window of opportunity” is closing fast. By this time you are already well on your way to experiencing hypothermia.

(If possible, take action before this stage. You may still have time to either stop the trip or take out early. Planning for an early takeout and/or shuttle halfway pays dividends.)

Moderate hypothermia

(shivering may decrease or stop):

Victim may seem irrational with deteriorating coordination. Treat the same as above but no drinks. Victim should be kept lying down with torso, thighs, head, and neck covered with dry clothes, coats, or blankets to stop further heat loss. Seek medical attention immediately.

Severe hypothermia

(shivering may have stopped):

Victim may resist help or be semiconscious or unconscious. Removed from water, victim should be kept lying flat, on back, and immobile. Victim should be handled gently. Cover torso, thighs, head, and neck with dry covers to stop further heat loss. Monitor vital signs. Seek medical attention immediately.

Victim appears dead

(little or no breathing, no pulse, body rigid):

Assume victim can still be revived. Look for faint pulse or breathing for two minutes. If any trace is found, do not give CPR. It can cause cardiac arrest. Medical help is imperative. If pulse and breathing are totally absent, trained personnel should start CPR.

(The above material was adapted from the cold-water survival brochure that is part of the American Canoe Association’s *Paddle Safe, Paddle Smart* series. Consult www.americancanoe.org for additional information on paddle craft safety, technique, and instruction.)

Self-Help

A person dumped into cold water should get out as quickly as possible. If immersion occurs very close to safety, such as a shoreline, then the person should swim the short distance to get out of the water, even if that means abandoning a capsized boat and gear. However, if the distance is more than a few yards, the person should either get out of the water as much as possible on a capsized boat or assume the H.E.L.P. or huddle positions until help arrives. Help should never be far away on a properly planned float trip.

Swimming will generate heat through exercise, but the increased water flow caused by swimming will rapidly conduct that heat away. Even a good swimmer will not be able to swim very far in cold water. Also, heat loss is concentrated at the head. Therefore, floating techniques with the head in the water should not be used in cold water; e.g., facedown survival floating or floating on the back. A person's ability to sustain themselves in cold water improves greatly if he or she is wearing a life jacket before immersion.



Heat Escape Lessening Posture (H.E.L.P.)

Huddle position





Boating Basics

Boating Terminology

Like other specialties, boating has a special language. Familiarity with basic terms is needed for good communication. *Fore* is toward the front or the *bow*; *aft* is toward the back or the *stern*. *Starboard* is the boat's right; *port* is the boat's left. The *beam* is the maximum width of the boat, and to move *abeam* is to go sideways.

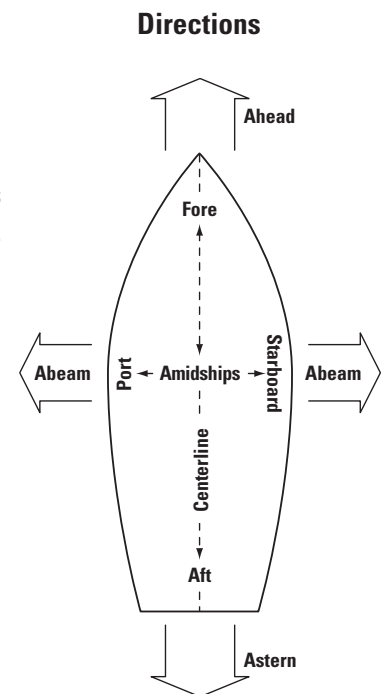

Basic Parts

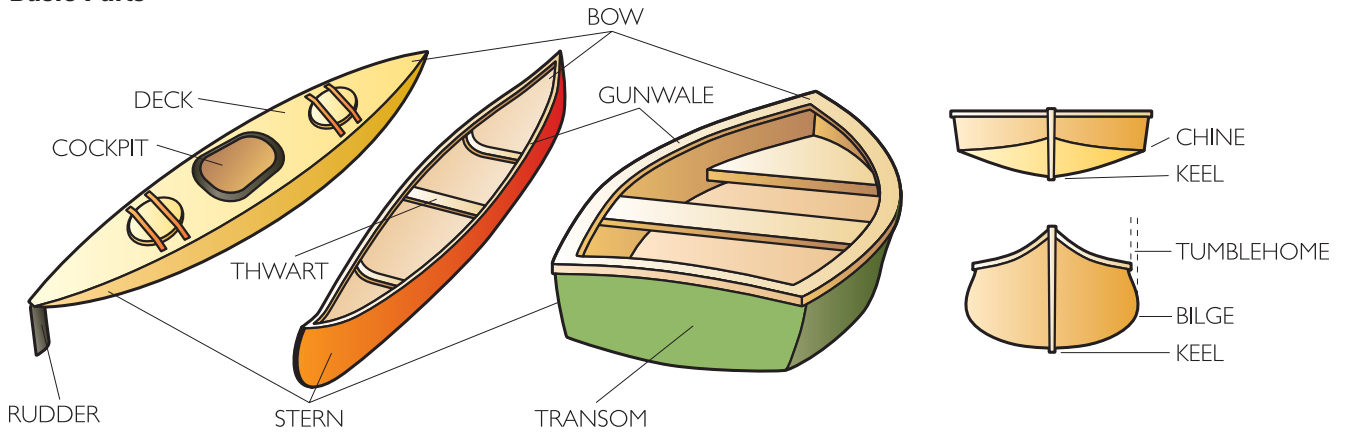

The *gunwale*, pronounced *gunnel*, is the top of the side in an open boat, or where the *deck* connects the side in a closed boat. A *cockpit* is an opening in a decked boat. A *transom* is the piece across a flat stern. A *keel* is a strength member running fore and aft along the center of the bottom that is often missing in molded boats. A *chine* is a seam or distinct change between the side and the bottom. The

bilge is the curvature between side and bottom when the two are not distinct. *Bilge* can also indicate the deepest depth on the inside of the *hull*, which is the part of the boat that forms the sides and bottom. Chines, *freeboard*, *rocker*, *sheer*, *length overall (LOA)*, *load waterline length (LWL)*, and *beam* are all design elements that influence how the boat performs its function.

Dimensions

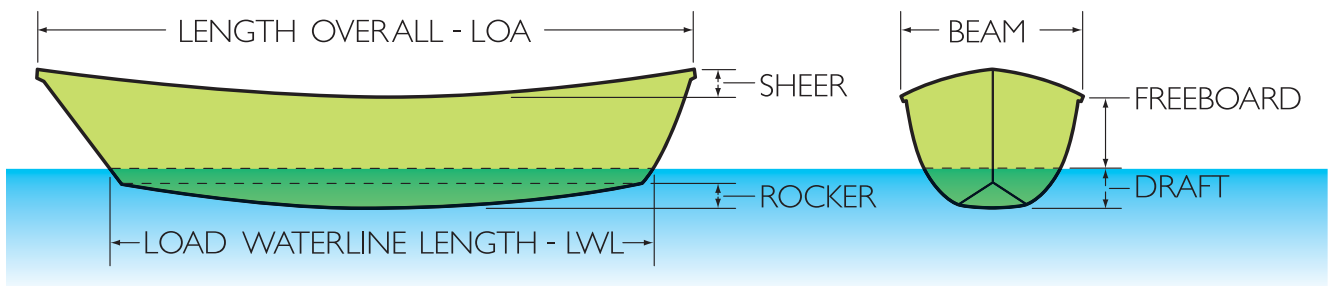

Displacement hull



Planing hull

Hull Forms

At low speeds, all boats *displace* water, or push it aside as they move through it. As speed increases, some boats are designed to remain *displacement hulls*. Other boats are designed to *plane*, or skim along the surface of the water once the speed reaches a certain point.

Displacement hulls become faster as beam decreases and length increases. A touring canoe is a good example of a well-designed displacement hull. However, length affects turning ability, so whitewater canoe designs sacrifice speed and tracking in favor of maneuverability by shortening the hull and adding rocker.

Planing hulls tend to be flat, although many will have a shallow V shape to improve directional stability. Flat-bottomed boats tend to pound in rough water and skid around turns. Simple planing hulls often have a hard chine between the sides and bottom that is above the waterline at the bow and curves down to the corners of a flat transom. Stepped-chine boats have multiple planing surfaces to allow rapid acceleration, but don't handle rough water as well as a single-chine form. Rough water characteristics are improved by using inverted V forms at the bow grading to a flatter hull at the stern. Small planing sailboats and surfing kayaks tend to have simple hull forms, whereas a multitude of hull designs are used for small powerboats.

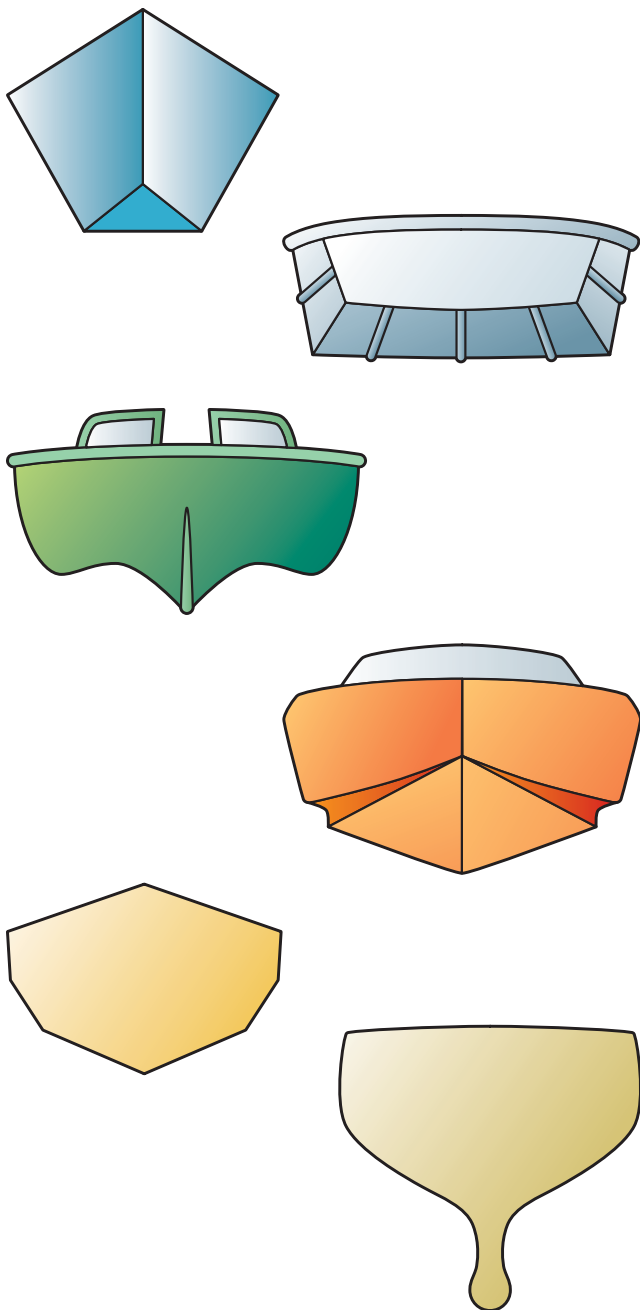

Boat Stability

The shape of the hull also affects stability, which is an important safety consideration for small boats. Stability reflects how well a boat resists a tipping force. A boat is not very stable if a small load shift or a swell causes the boat to capsize. Stability is measured by the restoring force as a function of tilt angle, that is, how hard the boat pushes back if you push down on the side. A round log has no force to counter rotation. A racing shell has very little. A properly loaded canoe has a surprisingly large amount, and a wide, flat-bottomed johnboat has even more.

Although the width, freeboard, and cross-section shape of a hull all influence the stability of an empty boat, load distribution is the primary factor in how likely a boat is to capsize in various conditions. Two large adults, plus gear, in a 70-pound canoe can easily shift the boat's balance from stable to unstable.

A canoe is most stable when the paddlers are kneeling. Occasionally, it is useful to stand in a canoe in calm water to scout ahead, but standing needs to be done carefully. Two people standing is a recipe for trouble.

<p>U. S. COAST GUARD MAXIMUM CAPACITIES</p>
<p>9 PERSONS OR 1300 LBS. 1375 LBS. PERSONS, GEAR</p>
<p>THIS BOAT COMPLIES WITH U. S. COAST GUARD SAFETY STANDARDS IN EFFECT ON THE DATE OF CERTIFICATION.</p>
<p>MANUFACTURER:</p> <p>ABC MARINE, INC. P.O. BOX 1234 CITY, ST 12345</p>

Overloading contributes to boating fatalities. Don't exceed the manufacturer's recommended load as found on the boat's capacity plate.

Technical Aside: Primary and Secondary Stability

Many canoeing and kayaking books contend that certain hull shapes have poor “primary” stability but good “secondary” stability. Similar observations are applied to sailboats and other craft. To understand the concept, a basic review of forces is needed. Gravity, acting through the center of mass of the boat, gear, and crew, pulls the boat down. Displacement, acting through the boat’s center of buoyancy, pushes the boat up. The boat is in equilibrium when the forces of gravity and buoyancy are balanced and directly opposed to one another. If the boat is

In equilibrium

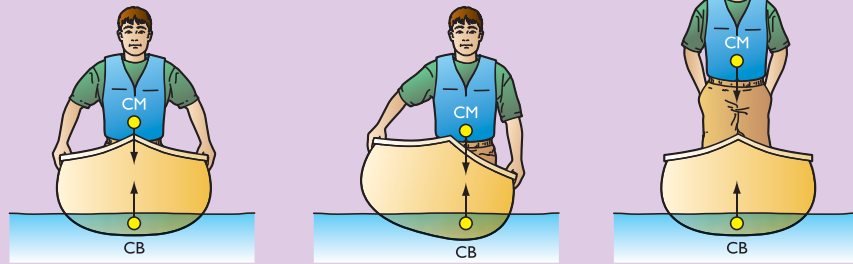

Stable

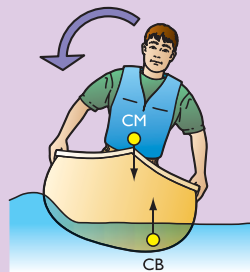

Unstable

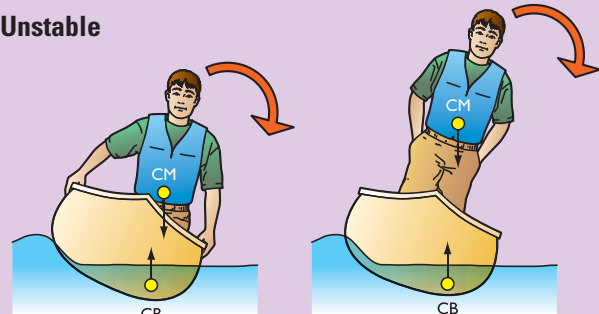

tilted from its equilibrium position, the boat is stable if the center of buoyancy shifts outboard of the center of mass, and unstable if the center of gravity shifts outboard of the center of buoyancy, as shown in the figures.

The size of the force acting to right a heeling boat depends on the separation of the center of mass and center of buoyancy as a function of angle. The graph shows hypothetical curves for two flat-bottomed boats, one wide with low freeboard, the other narrow with high freeboard. The first boat has a large righting moment at low angles of heel. Such a boat has good **initial** or **primary stability** and is **stiff**, that is, difficult to heel initially. However, due to the low freeboard, it can only be leaned half as far as the other boat before capsizing. The second boat has less righting moment at low angles. Such boats are **tender** and will tend to roll in waves or as cargo is shifted. However, the righting moment grows large at larger angles of heel. Such a boat is said to have good **secondary stability**. It takes a larger outside force to capsize this boat than the other, even though the first boat feels less “tippy.” Note that good secondary stability does not necessarily mean that a boat is designed to be operated with a heel, as the canoe in the second illustration above or most sailboats. If the forces on a boat are realigned to establish equilibrium at a heel, then the righting curves in the graph would need to be recalculated.

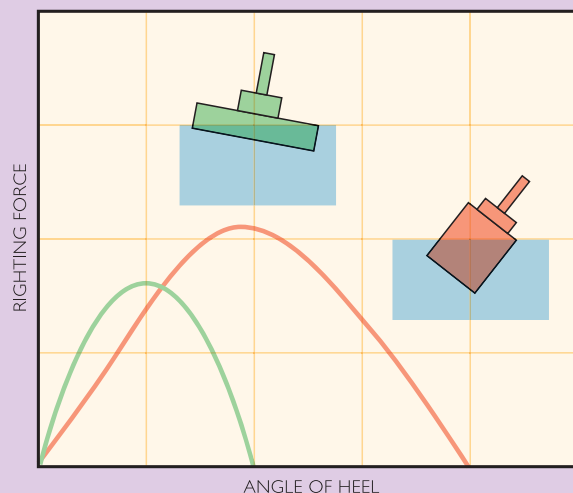

A boat’s seaworthiness depends not only on resistance to heeling forces but also on **pitch** and **yaw** characteristics; that is, how the boat reacts to longitudinal and turning forces. General hull traits, such as width, freeboard, and cross-section shape, indicate seaworthiness but aren’t completely reliable. Also, ultimate stability for small boats often depends as much on load distribution, or **trim**, as on hull shape.

Rules of the Road

Everyone operating a boat has the responsibility to avoid collisions with other craft. Therefore, the craft should always be under control, at a prudent speed, with a constant lookout.

Rules establish which boat has the “right of way” in various situations. However, not all recreational boaters understand or follow the rules, so each skipper is responsible for taking evasive actions if the other boat doesn’t respond according to the rules. The following

illustrations cover common situations in recreational boating. **More-maneuverable boats should give way to less-maneuverable boats.** Because the ability of sailboats to maneuver depends on the wind direction, rules for sailboat-to-sailboat interactions are more complicated. Specific requirements may vary from state to state but generally follow the rules for federal waterways. The complete rules, which differ somewhat between inland and international waters, may be obtained from the U.S. Coast Guard Office of Boating Safety: www.uscgboating.org.



Small recreational boats should yield right-of-way and stay clear of large commercial vessels, particularly fishing boats with nets deployed or strings of barges.



All boats must proceed at low speed in the vicinity of military vessels and must not approach closer than 100 yards without permission.

Boats under power should yield right-of-way to wind- or human-powered craft; e.g., sailboats, canoes, and kayaks.

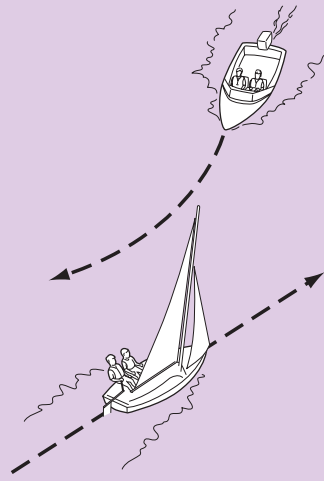

When powerboats are crossing, the boat to starboard has the right-of-way. That is, yield to a boat on your right, but proceed on course if the other boat is on your left.

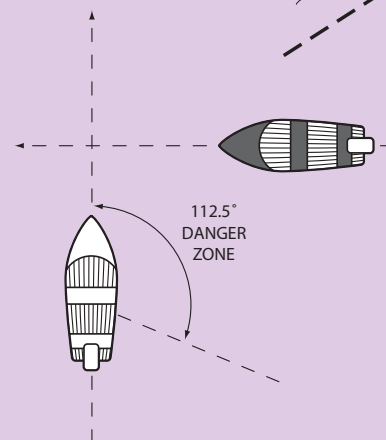

Powerboats meeting head-on each veer to the right (starboard) so that they pass left side-to-left side (port-to-port)—the same as cars meeting on an unmarked gravel road.

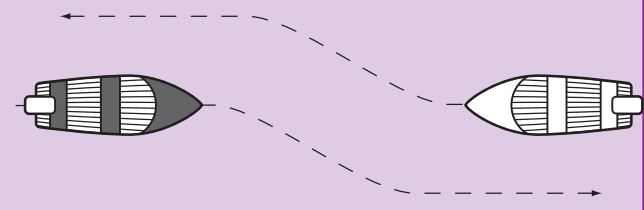

Any boat overtaking another from behind should avoid the slower boat ahead.

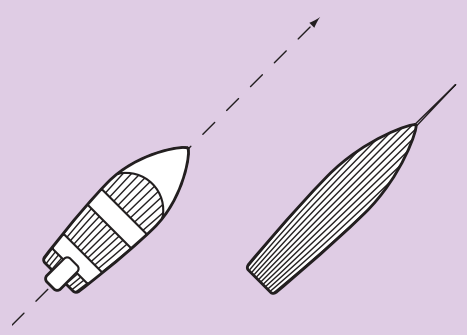

Signs, Markers, and Navigation Aids

Rivers, lakes, and coastlines often have marker buoys deployed in the water to warn of danger, to mark channels through shallow water, and as general aids to navigation. These are useful to sea kayakers as well as powerboaters and sailors, and warn canoeists away from dam structures and other dangers. The markers should appear on area charts. Local authorities, canoe liveries, and landowners may also post information signs on the shore.

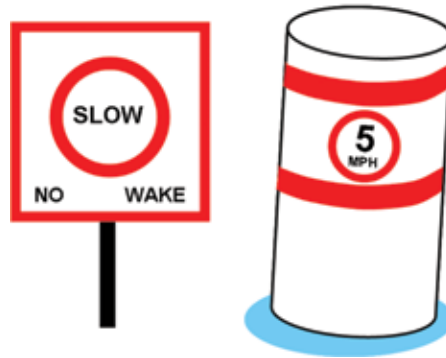

White can buoys or signs with orange circles indicate controlled areas.

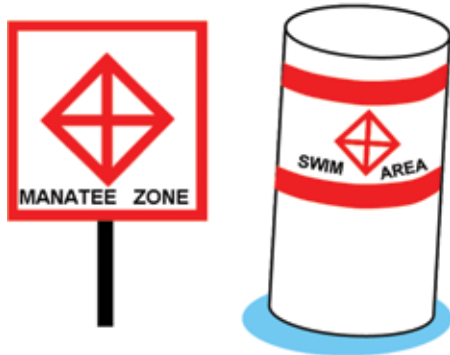

White can buoys or signs with orange, crossed diamonds indicate areas prohibited to boaters.



Stay well clear of boats or floats with dive flags indicating scuba divers or snorkelers in the water.

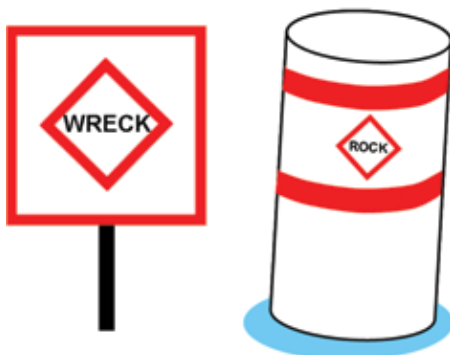

White can buoys or signs with orange diamonds indicate dangers.



Be alert for informal signs on shore that provide location checks or instructions.

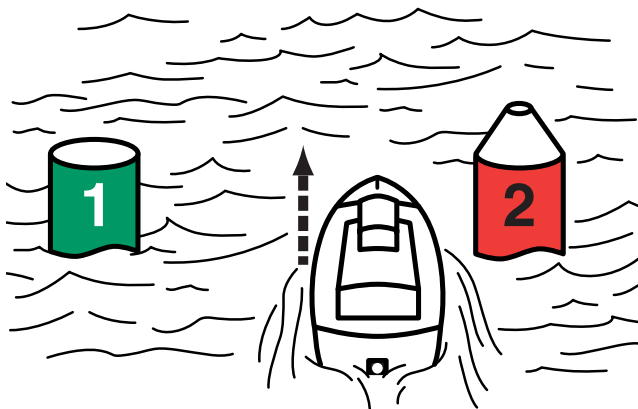

The general rule for channel markers is red right returning. When returning to shore, going upriver, or traveling south on the Intracoastal Waterway, keep red, even-numbered cones or triangular signs on your right, and green, odd-numbered cans or square signs to your left. Slow, shallow-draft boats should stay at the edges of the channel to allow passage of larger craft. Even shallow-draft boats such as kayaks may need to stay within the channel markers to avoid damage to and from coral reefs, to avoid sandbars at low tide, and to stay clear of weeds and breakwaters.

Boats and the Law

Legal requirements for boats and boaters arise from various jurisdictions, including federal, state, and local. Enforcement agencies include the U.S. Coast Guard, the Army Corps of Engineers, and park services. Safety Afloat requires you to know and follow all regulatory requirements. Check with local authorities to verify and complete the material given here. The website of the **National Association of State Boating Law Administrators**, www.nasbla.org, has links to state agencies responsible for boating laws.

Registrations



Motorized craft must be registered in the state of principal use. Requirements include display of numbers and validation stickers and onboard possession of a certificate of number whenever the boat is in use. Some states require registration and fees for all boats, including canoes, kayaks, and inflatable rafts. In a few states, registration fees may be waived for boats registered to not-for-profit groups such as BSA councils and chartered units. Your certificate of registration will include your boat number and how it must be displayed. Normally, plain block letters and numbers not less than 3 inches in height must be affixed to the forward part of the vessel as shown.

Accident Reporting

Boat operators are required to promptly report to local authorities any serious boating accident involving loss of life, medical treatment beyond basic first aid, or property damage exceeding \$2,000. Incidents occurring during a Scouting function must also be reported to the local council.

Operator License

Some states require boat operators to be older than a minimum age and to possess a valid operator's license. Generally these requirements apply only to motorized vessels, but check with your state department of transportation or other appropriate agency. In many cases, an operator permit may be obtained by completing an online course.

Use Permits

Some lakes and rivers require boaters to obtain permits prior to use. Permit acquisition may be as simple as paying a fee on the spot to use a launching area, or as complicated as submitting an application to a national lottery a year or more in advance of a trip. Permits may specify numbers in the party, allowed campsites, and restrictions on fires and waste disposal.

Signaling Equipment

Following sections will expand on the type of equipment needed for a safe, enjoyable trip in various types of craft. However, all craft under federal jurisdiction are required to carry an audible device, such as a whistle, that can be used to signal other boats. For canoes, kayaks, and other small boats, it's a good idea for everyone to have a whistle attached to their life jacket during a float trip, even if it is not a local requirement.





U.S. AIDS TO NAVIGATION SYSTEM

(on navigable waters except western rivers and intracoastal waterway)

LATERAL SYSTEM AS SEEN ENTERING FROM SEAWARD

PORT SIDE (ODD-NUMBERED AIDS)

- GREEN LIGHT ONLY
- FIXED
- FLASHING (2)
- FLASHING
- OCCULTING
- QUICK FLASHING
- ISO

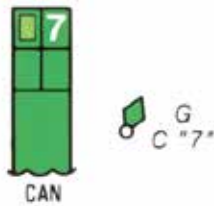
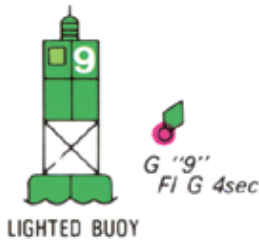

SAFE WATER (NO NUMBERS—MAY BE LETTERED)

- WHITE LIGHT ONLY MORSE CODE
- Mo (A)

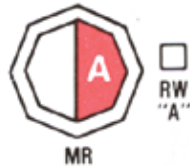
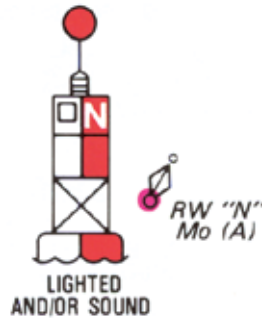

STARBOARD SIDE (EVEN-NUMBERED AIDS)

- RED LIGHT ONLY
- FIXED
- FLASHING (2)
- FLASHING
- OCCULTING
- QUICK FLASHING
- ISO

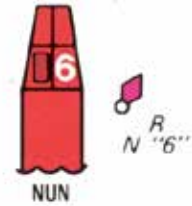
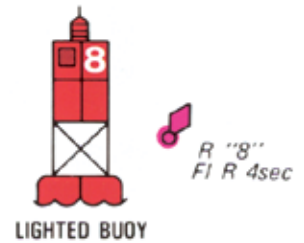

PREFERRED CHANNEL (NO NUMBERS—MAY BE LETTERED)

- GREEN LIGHT ONLY
- RED LIGHT ONLY
- COMPOSITE GROUP FLASHING (2 + 1)

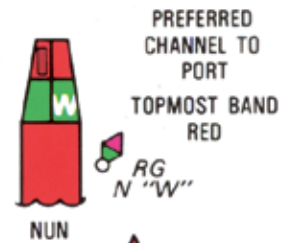
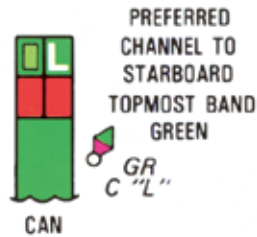
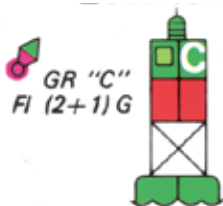



Canoeing Skills

Canoeing Activities

Canoeing is popular with Boy Scout and Venturing groups. Scout groups delight in canoe trips, whether for a day or a week, far away in the Canadian wilderness or on a local lake, or down a distant river or on a local stream. The material in this section is tailored to the cruising canoeist, but modern canoeing takes many forms, from dragon boats with large crews, to solo whitewater slalom racers, to freestyle “ballets” set to music. Specialized canoeing has led to a variety of canoe types and paddling techniques. There is no single best boat or universal perfect stroke.



General-purpose canoes of aluminum or composite materials are good for flat-water day-tripping or just messing around. Avoid hull materials that flex when moving through the water. Longer boats float higher, slide easily through the water, and track well. High-volume boats are good for carrying lots of gear on an extended trip. Lightweight boats are good when you need to carry the canoe across portages. Boats with little sheer and low sides offer less wind resistance; boats with raised ends take waves better.

Marathon and sprint racers use long, narrow, lightweight boats, often with asymmetric hulls. These specialized boats are seldom appropriate for Scout trips, but some of the stroke techniques can be adapted for cruising.

Downriver canoes designed for cruising in flowing water are shorter than their flat-water counterparts and have more rocker. They are a bit more sluggish and don't track as well, but they are more responsive and turn easier. They often are made of materials capable of regaining their shape after impact. Open boats, properly handled, are suitable for carrying gear through minor white water.

"Playboats" with flotation bags, pedestal seats, and thigh straps are used in heavy white water.

Whitewater competitors use decked boats resembling kayaks.

Learning to Paddle

First, learn to swim. BSA policies restrict canoeing instruction to those who complete the standardized 100-yard swimmer test. Second, seek out an experienced instructor. Canoeing is a physical skill, somewhere in difficulty between kayaking and ice skating. It is possible to learn through individual study and practice, but it's much easier with someone to guide the way. The basics can be learned in a few hours, but mastery takes concentration and practice. Don't get discouraged if the canoe doesn't always react as you expect. Go slow and easy until "canoe sense" becomes engrained.

With an accomplished paddler coaching from the stern, it is possible to learn while doing—during a flat-water trip, for example. However, it is generally better to pick up the basics in a class setting before hitting the water. Trying to learn on a trip when the wind picks up and your partner isn't as skilled, or patient, as he or she should be, can be a disheartening experience. Keep canoeing fun by learning and teaching it in a proper setting.

Safety Afloat requires Scouts to have three hours of training or to demonstrate proficiency before paddling on a float trip. The ability to perform the basic skills covered in this chapter constitutes appropriate training. Adults and Venturers may learn the skills by completing BSA Paddle Craft Safety training. Scouts who earn the Canoeing merit badge cover these skills and more. *Quickstart Your Canoe* and *Introduction to Canoe* by the American Canoe Association are also good introductory training programs.

Your instructor should choose an appropriate setting and tailor the lessons to conditions. Ideally, there should be no current until you are ready to master river skills. If a sheltered cove without wind or waves cannot be found, then the lesson may need to be postponed until weather conditions improve.

Your instructor should also provide or help you choose equipment appropriate for a novice. A long, stable boat that tracks well is preferable to a slender, tippy racer or a short whitewater boat with lots of rocker. Even those who can make a 17-foot cruising canoe respond to their every whim may find their first experience in a short, whitewater solo playboat to be like paddling an inner tube.

Choosing a Paddle

Canoes, paddlers, and paddles come in different sizes, and much is written about how to match one with the others. When you are positioned for paddling in the canoe, holding the paddle vertically at your side, the upper end of the blade, or throat, should be just underwater; the end of the grip, depending on who you ask, should be even with your shoulder, chin, nose, or eyes. Those few inches of leeway are a matter of preference or paddling style and shouldn't affect your ability to learn. That is fortunate since the paddles at many Scout camps come in 6-inch increments. Although scoffed at by some, a useful rule is that the grip of a paddle placed on the ground should come up around your chin, nose, or eyes. If the paddle is only mid-way up your chest, or over your head, it probably is either too short or too long. If you find two paddles, one at eye level and one just below your chin, take them both to the canoe and test them in the water. It's probably best not to buy an expensive paddle at a custom length until you have perfected your own paddling style in your own canoe.

Paddles angled at the throat may appear broken, but are deliberately built with angles of roughly 12 to 15 degrees and are used with the blade angled forward. Many marathon racers contend that bent-shaft paddles provide better stroke efficiency and will argue that results prove their advantage. On the other hand, Olympic sprint racers are allowed to use bent-shaft paddles but don't. Since some flat-water strokes are better done with a straight shaft, and straight shafts are generally preferred for white water, it is probably best for a novice to begin with a straight shaft. Some paddles have multiple bends in the shaft for a more comfortable grip, but those aren't widely available for instruction.

Paddles are made of different materials and have different-style grips, shafts, and blades. When you're just starting out, any of the common grips will be appropriate. Avoid excessively narrow or wide blades. Ideally, the shape of the shaft at the throat should be an oval, wider front-to-back to fit your hand. A circular cross section is fine, but avoid paddles that have the grip excessively wide from side to side. Also avoid the inexpensive, heavy, all-plastic paddles that flex during a stroke. Those are not recommended for Scout use.



Launching the Canoe



1. Use a perpendicular launch, either bow first or stern first, when the water is shallow, access is limited, or in waves. Carry the boat to the shoreline, place the paddles aboard, then lift from the center. Slide the canoe hand-over-hand into the water until it is floating free.



2. The paddler who will be at the end facing the shore steadies the canoe while squatting. The other paddler steps in the center of the canoe and moves into position by walking along the centerline while bending to grasp the gunwales.



3. The first person in the boat kneels in position and steadies the canoe with the paddle braced in the water. The second person then enters along the centerline. If the water is shallow, the second

person may need to go past their paddling position to the middle of the canoe to allow the shoreward end to float free. They assume their paddling position after the other paddler moves the boat slightly offshore.



To avoid damage to the hull, don't enter a canoe that is bridged, that is, has one end in the water, one end on shore, and an air gap between. You may need to wade into the water to ensure that the canoe floats freely before and after you enter.



Use a parallel launch from a dock, at a wide beach with deep water, or into a current. Place the boat in the water broadside to the shore and load your gear. One person steadies the boat while the other gets into position by stepping carefully onto the centerline of the boat. The first person in the boat then steadies the boat while the second person gets into position. In a current, carefully consider which direction to point the boat, and who enters first.

Safety Tip:

When moving around in a canoe, always maintain three points of contact: two feet and one hand, for example; or two hands and one foot, as shown in these illustrations.

Paddling Positions

Tandem paddlers paddle on opposite sides from positions near the bow and stern. The boat should be trimmed roughly level fore and aft. Adjust the trim by moving gear and paddlers.



Kneeling in the center of the canoe, with knees apart and braced against thigh straps, provides the best stability and allows a quick shift of the paddle to the other side.



Kneeling vertically, but slightly toward the paddling side, helps with stroke execution. Weight should be against a thwart or seat edge, not on the knees. Pads help make kneeling comfortable even for long trips.



The knee opposite the paddle may be raised with the leg extended forward as an alternate relief position to kneeling with both legs.



A well-designed canoe will have seats positioned to provide comfort along with reasonable stability. In some designs, your feet may be tucked under the seat. In other designs, that might be awkward or risk entanglement.



One or both legs may also be extended forward from a seated position. Marathon racers sometime brace their feet against blocks.



Avoid sitting with lifted knees that interfere with your paddling.

Forward Stroke Overview

The forward stroke provides basic propulsion in all types of canoeing. It is simple in concept, although details vary from one canoeist to another. In all cases, the stroke can be divided into three phases: the **catch** phase (putting the blade into the water), the **power** phase (accelerating the canoe

forward), and the **recovery** phase (removing the paddle from the water and returning to the catch position). The upper drawings illustrate the catch and power phases for a seated marathon racer on the left, a kneeling cruiser in the middle, and a sprint racer in a high kneeling position on the right. The bottom drawings show the recovery phase.

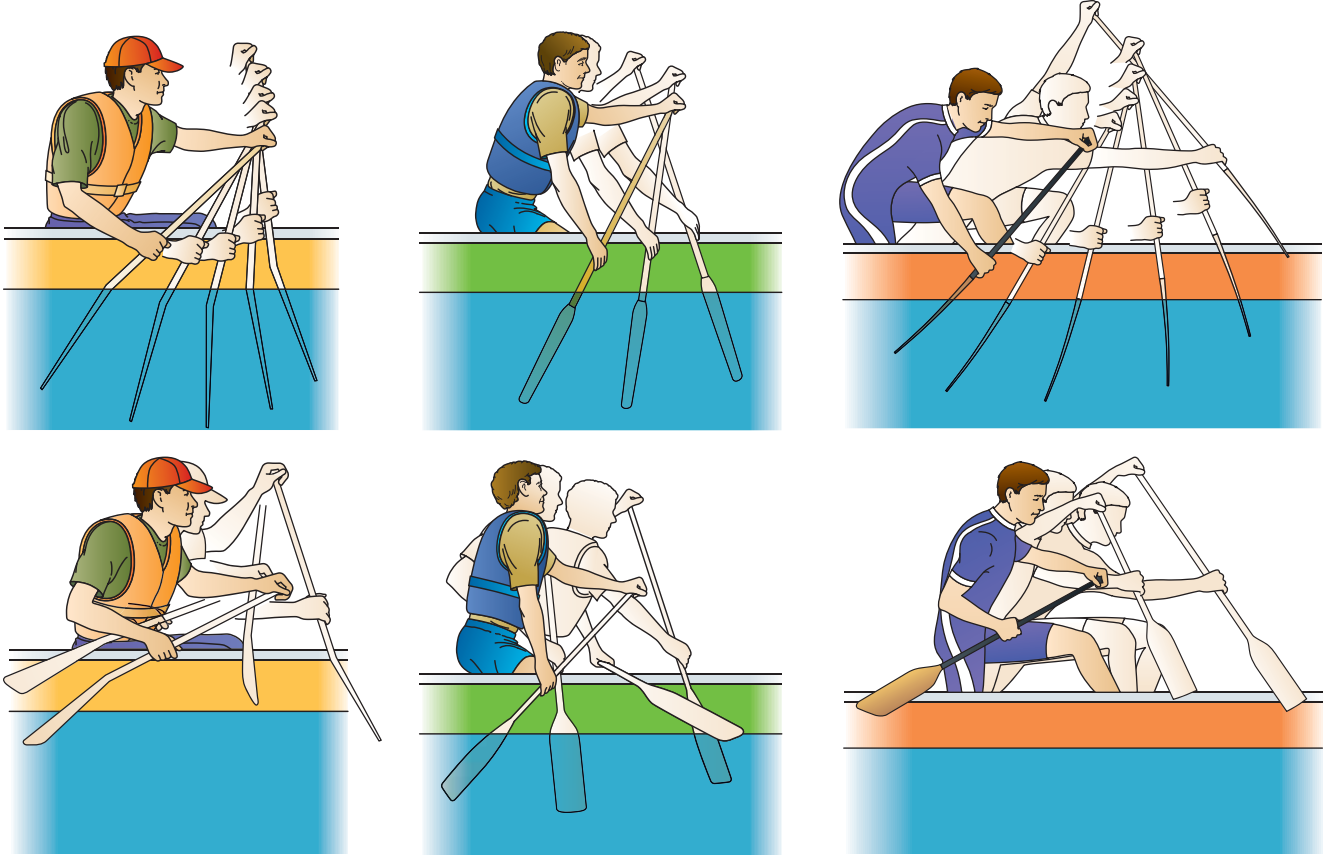

If you keep your back straight and your shoulders square, it is possible to do a forward stroke by bending your arms. However, it is more practical to use your back and shoulder muscles. Kayakers rely almost completely on torso rotation to generate power. They rotate their shoulders first forward, then back. At the other extreme, rowers in



whitewater rafts “put their backs into it” by leaning both shoulders forward and then back. Some authors suggest that canoeists should mimic kayakers. However, videos of flat-water and whitewater racing canoeists reveal various combinations of both rotation and lean. A cruising canoeist need not exaggerate either.

Forward Stroke Components

When describing strokes, it is useful to use the term **onside** to refer to the side of the boat the paddle is on. **Offside** is the opposite.

Just before the catch, the paddle blade is in the air over the water toward the bow. The hand on the shaft loosely grasps the paddle just above the throat with your hands a bit more than shoulder width apart. Your grip hand is just above eye level, slightly aft of the shaft hand and ideally over the onside gunwale. You may lean slightly forward, but there is no need to stretch or rotate uncomfortably.

You start the forward stroke by knifing the blade into the water by driving both hands down. Don't slap the water using only your lower arm.

During the catch, firmly grasp the paddle, but no tighter than needed. Pull back with your lower arm comfortably straight. Looking from the front, the shaft should remain vertical throughout the power phase. Pull straight back parallel with the boat's centerline rather than following the gunwale. Your grip hand will move just a bit forward and then back during the power phase. Ideally, the paddle should also be close to vertical when viewed from the side, at least as it approaches your hip. To transfer power from the paddle to the canoe, it is necessary to move the paddle backward more rapidly than the canoe is moving forward. However, think of the stroke as planting the blade in the water and pulling the canoe toward it.

To maintain your cruising speed, you only need to apply enough power to restore the momentum lost to friction and wind since your last stroke. That is easily, and most effectively, done in the short distance from the catch to or just past your hip. The power phase, either cruising or racing, is relatively short and ends once the paddle has stopped accelerating. The recovery begins in the water as you seek some way to remove the paddle without creating drag or other adverse affects.

Some folks let the paddle blade continue to arc upward past their hip. So long as the paddle is moving at constant speed, not jerked upward, that approach is reasonable and provides a relaxed stroke rate with time for course correction. Those in more of a hurry may slice the blade sideways out of the water or bend their lower arm to lift the paddle vertically. Still others rotate the grip to make the blade parallel with the canoe and slice upward. If you

don't overanalyze the situation, your natural tendencies will probably serve you well. When cruising, return the blade to the catch position by turning, or feathering, it sideways to avoid catching wind or waves.

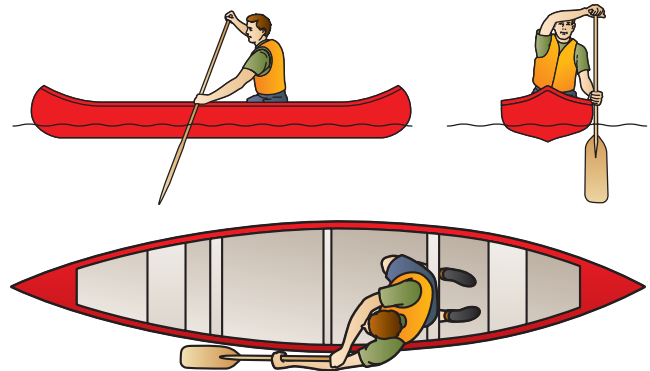

Catch



Power



Recover



Paddling in a Straight Line

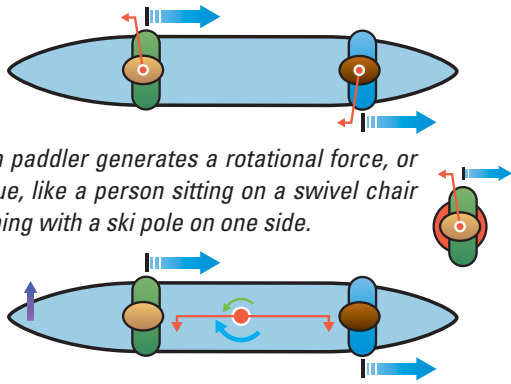

Each paddler generates a rotational force, or torque, like a person sitting on a swivel chair pushing with a ski pole on one side.

Torque depends on the distance from the center of rotation. The stern paddler typically generates more, like the person at the end of the seesaw, and the canoe veers off course.

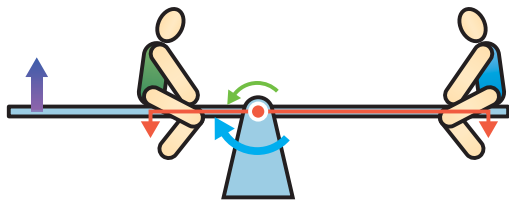

Paddling in a straight line is one of the more difficult tasks in flat-water canoeing, but it is really not that difficult if you are paddling with a savvy partner. Paddle on opposite sides, at the same time, and you are most of the way there. However, even though each paddler pulls parallel to the centerline, the offset from the centerline to the gunwale generates a slight sideways force, or torque. In most canoes, the stern paddler is farther from the boat's pivot point than the bow paddler, and the mismatch of forces eventually causes the boat to turn away from the stern paddler's side. To compensate, the bow paddler can pull harder or the stern paddler less forcefully. The stern paddler might even skip a stroke or use the paddle as a rudder. If the wind is blowing from the side, the stern paddler can paddle on the side opposite the wind. Any of those methods will work if you have patience and aren't battling a gusty headwind or a current. If you're in a hurry or a jam, you can always switch sides every few strokes. Marathon racers routinely switch sides to relieve muscle fatigue, and their boats track well. However, novices trying the **hit-and-switch** technique tend to zigzag or snake through the water. It's worth the effort to learn other techniques for maintaining a straight course. Tandem and solo sprint racers make a beeline over a kilometer or more, and anyone taking the time to switch sides during those races would lose.

Stern Correction Stroke

The stern paddler can always pull the bow toward their paddling side by adding a hook, pry, or reverse sweep at the end of a forward stroke. Whitewater paddlers make those combinations to forcibly turn the bow in the direction they desire. However, those techniques are more powerful than needed by a flat-water cruiser, tend to make the boat zigzag, and kill forward momentum. Only a slight modification to a cruising forward stroke is normally needed to make the necessary course correction.

The stern paddler wishing to compensate for the tendency to veer off course simply rotates the paddle during the completion of a forward power stroke by turning the thumb of the grip hand downward. The rotation begins as the blade nears the hip. Once the blade is parallel to the centerline, it is pulled past the hip and then lifted from the water. The amount of correction can be adjusted by when the rotation is started, by varying the angle the paddle is rotated, and by moving the grip hand slightly outboard of the shaft hand. The proper name for this stroke is the **pitch stroke**. If a turn is needed rather than a simple correction, the blade can be pushed outward at the end of the stroke. That makes the pitch stroke more akin to the classic **J stroke**.

There are numerous variations to the stroke just described. Any technique that lets you track straight without killing forward momentum accomplishes the task.

When you are first perfecting your stern steering stroke, concentrate on the motion of the blade rather than the direction the canoe is heading. Proceed slowly and stop just before the recovery to make sure your grip thumb is pointing down, the shaft is parallel to the canoe, and the blade is aligned fore and aft.

Once you think you have the idea, then work to keep the canoe on course. To check your mastery, try the stroke solo. Have the bow paddler turn to face aft while you demonstrate and explain the stroke.

If you try the stroke solo from a stop, you may need to take a few strokes starting with a short diagonal draw until you gain momentum. It also helps to learn in a boat that tracks well.

Draw and Pry



The draw stroke pulls the canoe toward your paddling side. Rotate your shoulders to face the inside gunwale, reach out with both arms, and plant the paddle in the water with the shaft vertical, one hand above the other, and the blade facing you. Then draw the canoe to the paddle.



If you need to make another draw, recover in the water by turning the blade perpendicular to the canoe and sliding it back out as you rotate to face the side. The thumb on your grip hand will point out.

Although both arms will be extended over the water, keep your body over the canoe to maintain stability.



The pry pushes the canoe away from your paddling side. Rotate as you would for a draw stroke, but place the paddle against the side of the canoe with the shaft vertical when viewed from the side. Your shaft hand should be just above the gunwale.

Your grip hand should be slightly outboard. Use the boat as a fulcrum to lever the canoe sideways as you pull back with your grip hand. The stroke should be short and powerful—don't pull in past the center. If you need another pry, feather the blade in the water and slice it back into position.

If the canoe has straight or flared sides, the paddle will pivot on the gunwale. The contact may be further down on a boat with tumblehome (inward curve of the side above the waterline).



Communication Tip: Tandem paddlers operate as a team. For long straight passages on flat water, the bow paddler provides power while the stern paddler makes minor course corrections, but both paddlers must work together when major course changes are needed. Clear instructions are essential, particularly if the course change must be done quickly. “Port” and “starboard,” as well as “onside” and “offside,” have their uses, but it’s hard to beat “right” and “left” to indicate direction. Canoeists almost always face forward. At other times, it may be useful to call out the name of a stroke. Either paddler may initiate action as required and should be able to rely on the other to respond appropriately.

Moving Sideways

Draws and pries are used in opposition to move the canoe sideways (abeam). Various combinations are shown below. Moving sideways may be useful from a stationary position, such as pulling away from a dock or assisting a person in distress; or while moving, for instance to avoid a submerged stump.



Sweeps

During a **sweep**, the paddle moves in an arc, or part of a circle. **Forward sweeps** with the paddle moving aft turn the canoe away from the paddling side. **Reverse sweeps** with the paddle moving forward turn the canoe toward the paddling side. In tandem canoeing, sweeps are quarter circles between the ends of the canoe and the side of the paddler.

A person in the bow begins a forward quarter sweep by rotating the onside shoulder toward the bow. The grip hand is kept low, and the shaft hand slides away from the throat as the blade is laid along the bow perpendicular to the water.



The blade is pulled away from the canoe as the torso is rotated to face forward. The blade is kept submerged near the surface. The power phase ends when the shaft becomes perpendicular to the centerline.

To recover, the blade is feathered flat over the water and arced back to the bow.

A forward quarter sweep in the stern position begins perpendicular to the canoe and arcs to the rear.



A reverse quarter sweep in the stern position begins at the stern and arcs forward until the shaft is perpendicular to the canoe.



A reverse quarter sweep in the bow position begins with the shaft perpendicular to the canoe and arcs toward the bow.



Turns and Pivots

Forward sweeps are used for gradual turns while under way. To turn away from the bow paddler's side, the bow paddler sweeps. To make the turn sharper, the stern paddler can add a pry at the end of a forward stroke.



To turn the other direction, the stern paddler sweeps. The bow paddler can assist in making a sharper turn by adding a draw at the beginning of a forward stroke.



Pivots are handy when you've been exploring a narrow cove and need to turn around. Pivots are circular turns within the boat's own length made around the boat's center. They may be done in one direction with both paddlers doing a draw, or in the other direction with both paddlers doing a pry. However, the use of quarter sweeps is more efficient since the paddles are farther toward the ends of the canoe.



To turn away from the bow paddler's side (offside), the bow paddler does a forward quarter sweep while the stern paddler does a reverse quarter sweep. Reverse the strokes to turn in the opposite direction.

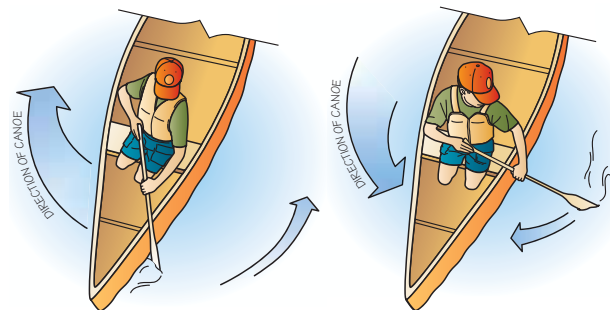

Stopping and Moving Backward



To stop a canoe, “**hold water**” with the blade vertical in the water at the end of a stroke.

To hasten the stop, or to move backward, stroke in reverse. Rotate your shoulders aft, place the blade in the water near your hips, and push the blade forward. When you can no longer keep the paddle reasonably vertical, feather it back to the starting point and repeat the stroke.

Quickly stopping a canoe that is traveling fast takes a large force to hold the paddle in place. It helps to hold the shaft against the side of the boat, but be careful about using your thumb to hold the paddle in place.

Landing

Land a canoe by reversing the steps you took to launch it. For a perpendicular landing, stop the canoe before it hits the bank rather than running it aground.



Rescue of a Distressed Swimmer

A canoe may be used as a rescue craft at a unit swim. Units on float trips may also be in a position to rescue swimmers or boaters without a life jacket who have been separated from their craft. Approach a distressed swimmer from stable paddling positions—kneeling, if possible. If you have an extra flotation device aboard, throw it to the swimmer as you approach bow first. After the subject has grasped the aid, or if there is no aid available, the bow paddler reaches out with a paddle. Once the subject grabs hold, the bow paddler swings the subject and bow together to allow the subject to grasp the end of the canoe. The bow paddler should give clear instructions throughout.



Swamped Boat Drill



Most canoeists inadvertently swamp a boat now and then. An intentional capsize helps prepare the boater for such an accident. To safely capsize a canoe, both paddlers should sit on the bottom of the boat facing the same side with their legs over the gunwale. One hand is placed on each gunwale. The partners then move their weight over the bilge and, if necessary, gently rock from side to

side until water comes in over the gunwale and fills the boat. The boat should settle in the water rather than flip.



Canoes will float even when filled with water. Capsized canoeists should remain with the boat, which is more easily spotted by rescuers than are swimmers. If near the shore, the swamped canoeists may swim the boat ashore or paddle it with their hands while sitting upright on the bottom. Their buddy boat should be nearby at all times.

Canoe-Over-Canoe Recovery

If the water is calm, the shore fairly distant, and the canoes not very loaded, then the buddy boat may elect to perform a canoe-over-canoe rescue, provided the swamped canoeists are not injured or in danger of hypothermia. If the swamped canoeists are in distress, then they should either be brought aboard the rescue craft or be towed immediately to shore unless the rescuers are proficient enough to retrieve their boat quickly. If the swamped boat is fully loaded with gear, it may be more practical for the rescue boat to tow it ashore.



Come alongside the capsized canoe while instructing the people in the water to move first to the ends of their boat and then to the ends of your boat on the far side.

Either transfer their gear to your boat or let it float free for later retrieval.



The bow paddler turns to face the stern and may need to move toward the center. Swing the capsized canoe at a right angle to yours. As you raise the end, turn the canoe bottom up and rest the end on your gunwale.



Ease the swamped canoe across the gunwales of your canoe, scooting it along until it is balanced.



Roll the capsized canoe upright across your canoe and then slide it back onto the water on the same side you brought it from.



Hold the emptied canoe alongside yours and stabilize it as its crew climbs back aboard one at a time. Allowing the gunwale near your boat to lift slightly will make it easier for them to board.

Deepwater Entry

If you fall overboard without swamping your canoe, or need to reenter a canoe after a canoe-over-canoe recovery, then the following technique will be useful. Your partner or buddy boat can help by steadying the canoe with the gunwale down on the side you are entering.



Enter from the middle where the gunwale is lowest; push down on the gunwale with both hands to bring your hips above the water. A strong kick may help. Your partner needs to provide counterbalance.



As your hips come up, lean forward to grasp the opposite gunwale or along a thwart.



Rotate your hips to sit inside the canoe with your legs over the gunwale. Then bring your feet aboard. Move to a paddling position to steady the boat if your buddy still needs to enter.

Other procedures for deep water entry are shown in the *Canoeing* merit badge pamphlet.



Some people prefer the heel hook method.



An easy method if a short line or strap is available is to use a loop as a stirrup.

Technical Aside: Power to the Paddle

Books on canoeing often note that the canoe is pulled to the paddle rather than the paddle moved through the water. When the canoe is moving at a reasonable pace, the paddle is almost stationary in the water, but not quite. You move the canoe forward by accelerating water backward. Canoes, kayaks, swimmers, and powerboats all respond according to Newton's third law of motion: For every action, there is an equal and opposite reaction. If the paddle, hand, or propeller didn't slip at all, water would not be moved backward (the action), and there would be no momentum imparted to the canoe through the paddle (the reaction).

Consider moving a large, heavily loaded canoe from a stop using a paddle. On your first stroke, you will accelerate a mass of water backward, and the boat will respond by accelerating forward. The force on the water (mass \times acceleration according to Newton's second law) imparts an opposite force of the same magnitude on the boat. However, because the boat is massive (heavy), it will accelerate only a little compared to the water moved by the paddle. During the stroke, the paddle may move backward more than the canoe moves forward.

Although a single stroke won't make the canoe move very fast, it is efficient. Some of the energy is lost to friction—that is, pushing water aside—but most of it imparts momentum to the canoe. Were it not for friction, the boat would continue gliding slowly all the way across the lake (Newton's first law). You can minimize energy loss to friction by letting the boat glide to a stop between every stroke, but your pace will be slow. Instead, take a few powerful strokes to reach the cruising speed you would like, and then cut back on the power to balance propulsion against friction. Be aware that friction increases rapidly with speed. Short, easy strokes at a uniform, relaxed pace will let you eat up the miles without overexertion.

Now consider the following diagram of paddle motion of an Olympic sprinter moving past a fixed point.

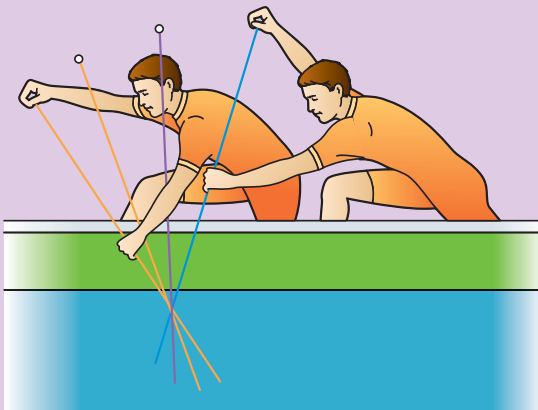

As the blade is punched into the still water, the shaft of the paddle continues to move forward at boat speed. If the paddler resisted that motion by holding the shaft fixed to the boat, tremendous drag would result—that's how you stop.

If the paddler allows the shaft to move backward relative to their body at the speed of the boat, little is accomplished. There is a bit of drag, but no energy added to the boat. To add energy, the paddler must pull back on the paddle to make it move backward faster than the canoe is moving forward. That is, the still water must be accelerated backward. To do that, the paddle must push backward relative to a point fixed in the water. The end of the blade rotates aft in the diagram, though not by much.

Once the water begins moving in response to the paddle, it must then be moved even faster to impart more energy. That is, the water must be accelerated by an accelerating paddle. Moving the paddle backward at constant speed doesn't have much effect, either positive or negative. If you aren't in a big hurry, it doesn't really hurt to allow the paddle to continue past your hip to the surface. You probably won't win a race, but neither will you noticeably pull the boat down into the water unless you jerk the blade upward. A slower recovery allows your muscles to rest between strokes and allows time for a steering stroke.

The racer is only able to accelerate the paddle over a short distance. At this point, various physical and physiological limits have been reached. All the paddler can do is add just enough energy to make up for the energy lost due to the friction of the boat moving through the water. The boat continues toward the finish line at fairly constant speed. The athlete is unable to move the paddle fast enough to make the boat go faster.

Note that the paddle blade changes angle, or rotates about a moving point, during the power phase. Ideally, the blade should be held vertically at all times, but that is not the case. Fixing the blade at an angle to the shaft, as in a bent-shaft paddle, would allow a more vertical angle at the end of the power phase, but it is not clear what impact that has on the entire stroke or how the timing of the stroke should be modified to take advantage of the bend. The hydrodynamics are extremely complicated. Rather than rely on an oversimplified analysis, be open to trying different paddle designs with various grips, shaft lengths, blade shapes, and blade angles. Then enjoy paddling with whatever paddle strikes your fancy.

Two-person lift and carry

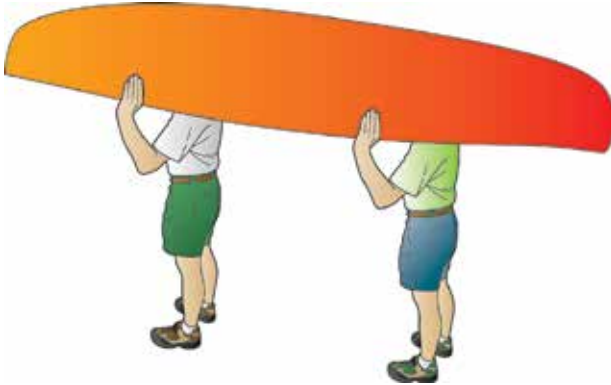
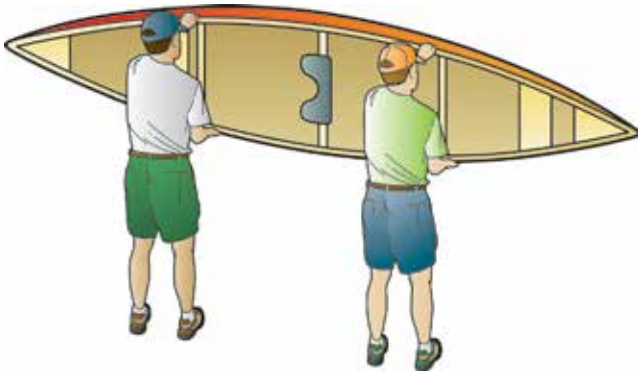

Portaging

Two people can efficiently carry a canoe from a rack or a trailer a short distance to the water by grasping each end. Other techniques are useful when longer distances are involved, particularly when gear needs to be carried at the same time. The following techniques can be used to portage a canoe around a rapid or between lakes.

One-person lift and carry

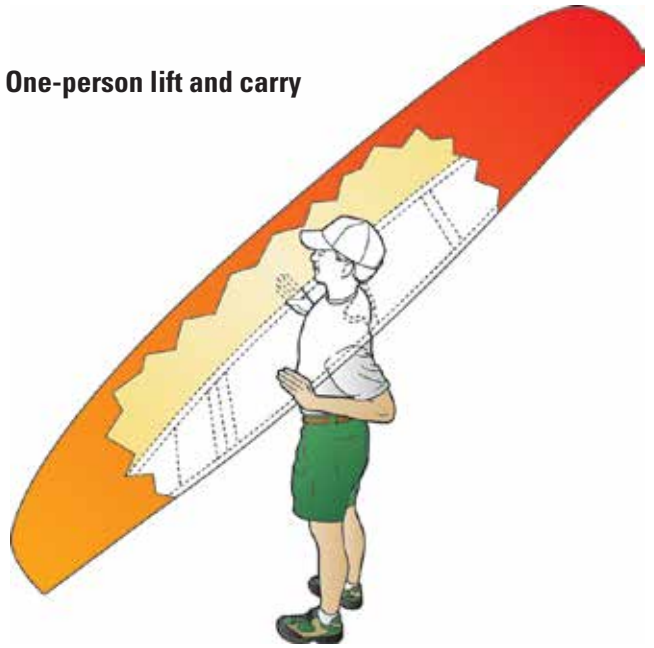



Kayaking Skills

Comparisons between canoes and kayaks are inevitable. Traditionally, a canoe was an open boat designed for transporting goods and people, whereas the kayak was an enclosed single-person craft used for hunting. Canoeists typically used a single-bladed paddle but occasionally adopted the double-bladed paddle usually used by the kayaker. Those classic differences persist today; the casual observer may easily confuse an enclosed competitive whitewater canoe with a kayak, except that one paddler will use a single blade and the other a double.

In recent years, kayaking has rivaled canoeing in popularity. The reasons are many. An inexpensive kayak often costs less than an inexpensive canoe, though high-end models of either are pricey. A short, decked kayak in expert hands can safely negotiate white water that would be impossible for the most experienced team in a long, open canoe. That's one reason whitewater-canoe designs have adopted kayak characteristics. On the other end of the design spectrum, a double touring kayak may not have the capacity or ease of portage of a touring canoe, but can carry sufficient supplies for a long trek. However, ease of use may be the kayak's greatest appeal to the novice boater.

The difficulty of gaining reasonable proficiency as a solo canoeist may be likened to that of learning to ride a bicycle. The first attempts are likely wobbly and may be frustrating. Practice and patience are needed before confidence is achieved. A novice in a kayak, however, may quickly find that the boat responds agreeably, somewhat akin to starting out on a bicycle with training wheels. Imperfect analogies aside, both the canoe and the kayak have their champions and both will satisfy recreational needs into the future, whether those needs are to connect with nature on a remote backwater, to find thrills on a swiftly moving river, to compete with others in endurance and skill, or simply to delight in the graceful coordination of craft, body, and thought.

Kayak Designs

Kayaks come in a wide assortment of designs intended for different paddling activities. For example, a flat-water sprint racing kayak is designed for light weight and easy tracking, whereas a whitewater slalom racer is short with pronounced rocker for easy turning.

Originally, kayaks were made of sealskins stretched over a wood and bone frame. The Inuit used them for hunting and fishing. Early recreational kayaks were made of cloth over wooden frames, and some modern **folding** kayak designs still use fabric on a frame.



Typical **recreational** kayaks are designed for versatility. They are of moderate length and have large cockpit openings. They are great for learning and short trips on protected waters. Most inexpensive models are made of molded polyethylene plastic, which is durable but weighs more than other construction materials. Some designs have double cockpits for tandem paddlers.



Sit-on-top kayaks lack a cockpit and have seats and foot braces molded into the deck. They often are made of polyethylene and come in single and double versions. They are great for short excursions in warm waters and are good support craft for snorkeling. Expect a wet ride. Specially designed sit-on-tops are used for surfing ocean waves, which is not an activity for a novice.



Touring kayaks are larger and have dry storage capacity for camping gear. They are long, often up to 17 feet for single versions and close to 20 feet for tandem models. Even though long lengths with little rocker help tracking, many models are also equipped with a folding rudder. Fiberglass or Kevlar composites are often used in construction to reduce weight. Spray skirts help keep out water. These boats are also known as **sea kayaks** due to their use around ocean shorelines.

Whitewater kayaks typically have short hulls with pronounced rocker. **Creek boats**, **playboats**, and **squirt boats** have various design features such as blunt ends, multiple chines, and planing hulls depending on whether the goal is the first descent of a wild river or performing cartwheels and spins in a rodeo competition. Some designs have different tips to adapt a basic hull to different specialties.



Inflatable kayaks have flat-water and whitewater uses. They can be deflated for easy transport and provide a fun experience in many settings. A lack of rigidity can affect performance, but inserts are used to improve stiffness.

Note: Some kayak designs come in different sizes. You should fit snugly but comfortably in a kayak with a cockpit.

Parts of the Kayak

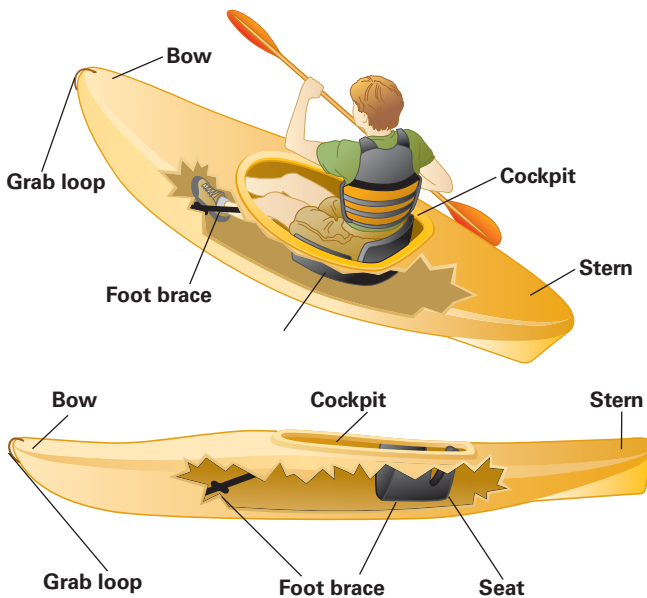

Learning to Paddle

Kayaking BSA introduces Boy Scouts, Venturers, and leaders to basic flat-water kayaking skills. Check with your local council service center for approved instructors or ask the council aquatics committee to initiate a local program. The **Kayaking** merit badge teaches Boy Scouts kayaking skills and safety for calm water. Material in the merit badge pamphlet provides additional information to that given here.



If your council does not have a kayaking program, check with local paddling clubs for assistance. They may offer basic and advanced kayak classes using instructors affiliated with the American Canoe Association.

Paddles



The blades of kayak paddles come in various designs. Large blades provide more power per stroke; smaller blades take less energy per stroke. Many blades are lightly cupped or spooned for increased water resistance over a flat blade of the same projected area. The curve is oriented to scoop water toward the stern. Some blades are asymmetrical. That is, the shape of the blade above the centerline of the shaft is different from that below. The shape is designed to balance the area, and hence the force, on the top and bottom of the blade when the paddle shaft is inserted into the water at an angle.

Many paddles have the blades set at an angle to one another from 30 to 60 degrees. The offset angle automatically feathers the blade out of the water when the blade in the water is perpendicular to the boat's centerline. Feathering reduces wind and splash resistance. Touring paddles often come in two sections that, when assembled, allow the feathering angle to be varied.

A paddle with spooned, asymmetrical blades set at an angle has top and bottom sides and right and left ends. Depending on how the blade angles are set, paddles are either **right-hand** or **left-hand controlled**. Most are set in the right-hand control position. That is, the grip of the right hand will not change during use. The wrist of the right hand is rotated to set the proper blade angle on each side of the boat. The shaft rotates freely in the left hand. Quality paddles have an oval shaft, which provides better control and comfort and helps you set the correct angle. Most paddles have straight shafts, but a few designs are bent at the grip positions to ease strain on the wrists.



Correct paddle length depends on the length of the blades, on your dimensions, those of your boat, your style of paddling, and your personal preference. Generally, whitewater paddlers use a slightly shorter paddle than touring kayakers. Paddles are normally sized in centimeters with typical lengths between 190 and 220 centimeters, or around 6½ to 7 feet. Don't have a metric ruler handy? Stand with the paddle upright with one blade touching the ground. If the end of the top blade is less than head high, the paddle is probably too short. If you can't reach the top of the blade with the fingertips of your extended arm, the paddle is probably too long. Pick a size or two in between, see how they feel in the water, and check with your instructor.

Boarding



After checking on land that the kayak is a good fit, place the kayak in ankle-deep water or at the edge of a low bank or dock. Use your paddle for balance by placing one end on the bank or bottom and the other end just behind the cockpit coaming (rim). Sit on the deck, not the paddle, and place one foot in the cockpit. Bring the other foot into the cockpit, then slide your legs into the boat. Reverse the process to exit. On sandy beaches, some people board in a similar manner but with the bow of the kayak in the water and the back resting on the ground.

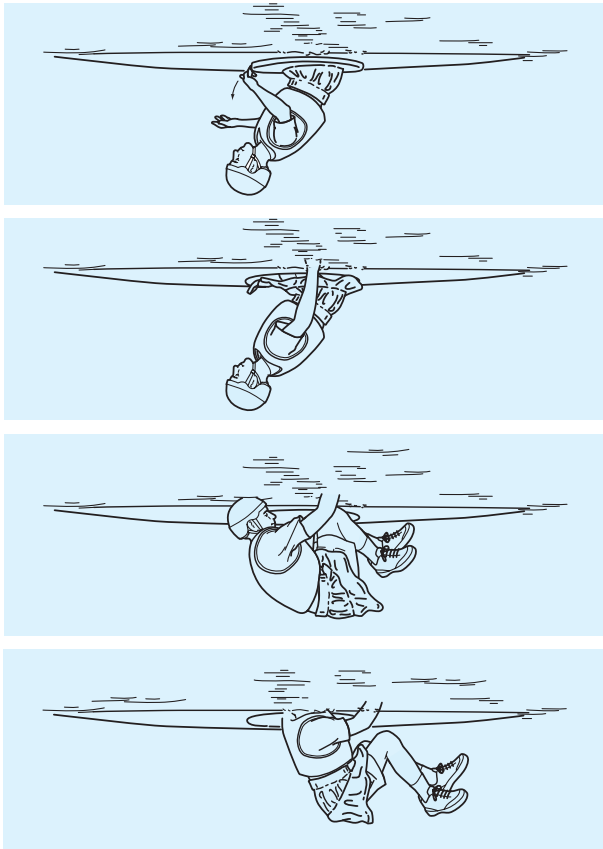

Capsize Drill

Kayaks are sufficiently stable that an unintentional capsize in calm water should be a rare event rather than a foregone conclusion. Even so, a capsize drill early in the learning process is a useful safety exercise to remove any apprehension about an accidental capsize during stroke practice.

A capsize drill for a sit-on-top or inflatable kayak is simple: lean over, slide off, right the boat if necessary, and climb back on board. A capsize drill for a decked kayak is only a bit more complicated. After you roll over, if you don't automatically fall clear of the boat, do the following: Lean forward and grasp the coaming behind your back. Straighten your legs and push the kayak forward with your hands as you slide your feet out. You should fall out of the cockpit in a somersault. Try to maintain contact with the kayak as you bring your head above water to one side. Master this technique in a pool or calm water before you need it. Make sure the water is free of obstacles and deep enough that you don't hit the bottom when you roll over. Both your buddy and your instructor should be watching.

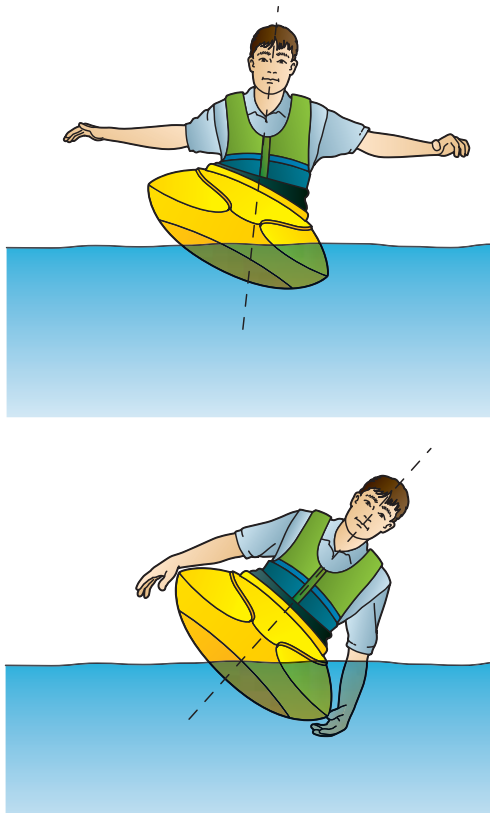

Balance

Kayakers “wear” their boats in the sense that power is transferred from the paddle to the boat through the torso, hips, and legs. Turns, braces, and rolls involve the hips as well as the paddle. You can experiment with hip action as part of the capsize drill. Try to tilt the kayak to the side using your hips, not your paddle. Keep your upper body upright so that your center of mass stays over the center of the boat. With practice you should be able to lean the boat almost 45 degrees to each side by cocking your hips. Flick the boat level again simply by moving your hips back to normal. When you are ready to practice capsizing, lean the boat not with your hips but by rolling your whole body to the side.

Opening Exercises

Do the following, either on land or on the water, or both, to prepare for paddling the first time. Space your hands by holding the paddle above your head horizontally with your elbows at 90-degree angles. Then hold the paddle level in front of you. The knuckles of your control hand should be aligned with the edge of the blade nearest that hand. If you are using a right-hand control paddle and you are grasping the shaft with your wrists flat, then the blade on the right will be tilted slightly forward. Hold the shaft firmly with your control hand and rotate the paddle by bending your wrist down and rolling your knuckles back. Let the shaft rotate freely in your other hand. Practice rotating the blades a quarter turn by flexing your wrist up and down. This exercise prepares you to angle the blade correctly on both sides of the kayak.

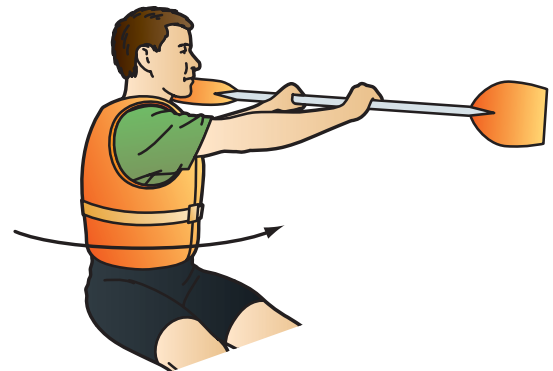
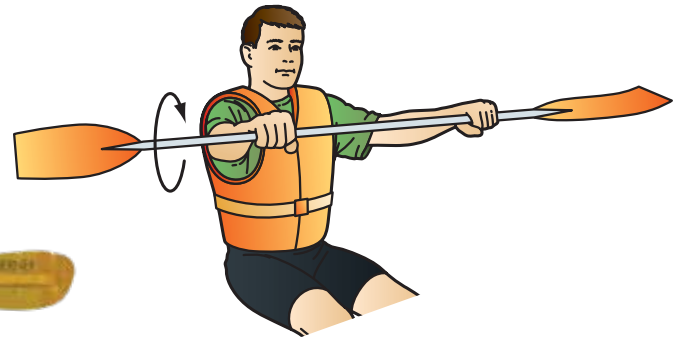
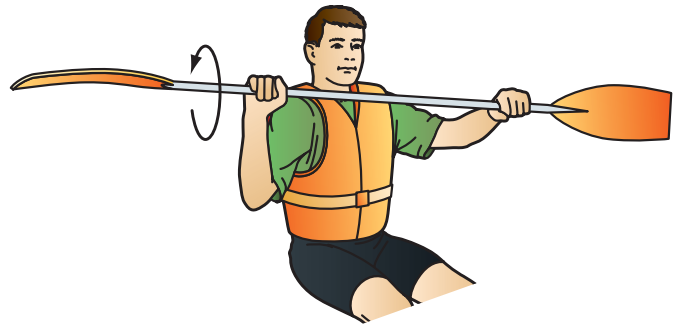

Next, with the paddle still level, push one blade forward and pull the other back by twisting your torso. Keep your elbows loose but don't change their angles. A few swings back and forth should loosen your muscles sufficiently that you are able to comfortably point first one and then the other blade forward. This exercise prepares you to derive power from torso rotation rather than your arms.

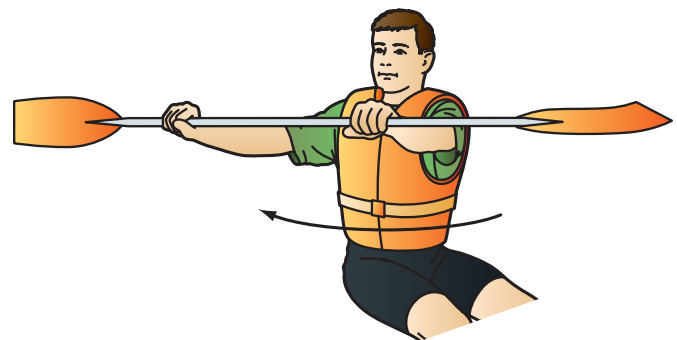

The Forward Stroke

Forward motion is achieved by stroking first on one side and then on the other. Extend your lower arm toward the bow and push down to plant the blade in the water. The blade should be perpendicular to the centerline of the kayak. Draw the blade back parallel to the centerline, ending the stroke when your lower hand reaches your hip. Your upper hand should be near eye level. Don't lean forward to extend your reach. Rather, keep your back straight and rotate your torso. After the blade has left the water at the end of the stroke on one side, rotate the shaft with your control hand to set the angle for the blade on the other side as you extend that blade forward. Repeat from side to side, making slight adjustments as needed to keep the kayak headed in the desired direction. Go slowly at first to get a feel for the interaction of the boat and paddle. Also make sure the region ahead of you is clear. The kayak will respond quickly.



Forward Sweep

Forward strokes are done with the blade close to the boat pushing the water to the rear; turning strokes are most efficient with the blade moved away from the boat in a half-circle. The circle for the sweep begins at the bow and turns the boat away from the paddling side. Your elbow, hand, and paddle blade will be lower on the opposite side than they are for the forward stroke. Power still comes from torso rotation. Recovery is done by feathering the power blade just above the surface. Several sweeps from one side from a stop will spin, or pivot, the boat. A sweep while under way will change the boat's direction, and can be adjusted to control the amount of the turn. A sweep on the other side will turn the boat in the opposite direction.



Reverse Sweep



You can also reverse the direction of the sweep to pivot the boat in the opposite direction without changing sides. A reverse sweep begins at the stern with the paddle shaft at a low angle to the water. Moving the blade in a forward arc turns the bow toward the paddling side.

Rudder



If you hold the blade vertical in the water at the rear of the kayak, you can use the paddle as a rudder to make minor course adjustments at the end of a forward stroke. You guide the kayak by pushing the blade toward or away from the rear of the boat. Angling the blade away from the kayak turns the bow toward the paddling side. In that case, your forward hand is slightly inboard of your back hand. Angling the blade toward the rear of the boat, with your forward hand slightly outboard of your back hand, turns the bow away from the paddling side. A rudder is only effective when the boat is moving. Deflecting water to the side creates resistance, which is translated into a course correction. The faster the boat is moving relative to the water, the quicker the response. However, a rudder also creates drag, which slows the boat. A forward sweep is generally more efficient for making turns under way.



Draw Stroke

The draw stroke moves the kayak sideways toward the paddle. Rotate your torso to face the side and reach out with your lower arm. Plant the blade in the water and pull the kayak toward it. Keep the blade almost vertical and parallel to the side of the boat. Recover with the blade in the water by twisting the blade perpendicular to the boat and slipping it back to the draw position.



Back Stroke

To stop the kayak, do a back stroke: the forward stroke in reverse. Continue to stroke backward on opposite sides to bring the kayak to a complete stop or to move it backward, also called backwatering. Don't forget to look behind you when using the back stroke.



Stroke Combinations

The few strokes described above give you enough choices for moving a kayak at will in calm water. Practice the strokes separately when first learning. Master each component sufficiently to make the kayak respond as intended. With a bit of practice, the actions caused by the strokes should begin to feel natural. After a while, you will not deliberately consider what stroke to use or worry about how to execute the stroke correctly. Instead, you will decide where you want the kayak to go and automatically direct the paddle to achieve that result.

Aiding a Capsized Paddler

As with the wet-exit capsizing drill, the difficulty of helping a capsized paddler depends on the water conditions and the type of craft. A sit-on-top kayak in warm water should present few challenges.

Your first concern if your buddy boat capsizes should be for the safety of the paddler, not his or her equipment. If the situation is urgent, due to injury or cold water, immediately tow the person to shore rather than chase after their gear. If your rear deck is large enough, the capsized victim may be able to balance on it. If your kayak is small, have the person hold onto the rear grab loop or toggle and float near the surface to reduce drag. If your buddy has hold of his or her boat and needs help getting it to shore, you can tow both the person and their kayak for short distances in calm water.

Once on shore, you can empty the water from the swamped boat by each holding an end and rocking the upside-down boat fore and aft to allow water to drain from the cockpit. Some kayaks have plugs near the ends so the water can be drained by simply holding up one end.

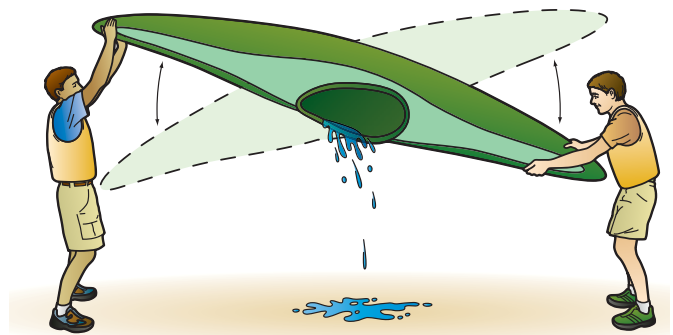

Kayak-Over-Kayak Assist

In calm water, a capsized paddler can sometimes resume paddling without returning to shore. Self-rescue in a decked boat often requires a paddle float to provide stability. However, that technique is not reviewed here because Safety Afloat requires buddy boats for any excursion. If the buddy boats are also in jeopardy, because the group was remiss in not getting off the water in sufficient time to avoid worsening conditions, the simple towing techniques discussed previously should be considered. Boat-to-boat rescues are difficult in high winds and waves.

If the capsized kayak has good flotation, and is either self-bailing or has a pump, you can hold the boat upright next to yours to allow the person to climb aboard.

It may also be feasible to empty a swamped kayak before the person climbs aboard. Form a “T” with the boats and have the swimmer steady your kayak from the rear. Pull the swamped boat upside down across your foredeck, and gently rock it back and forth to drain it of water. Steady the boat next to your own, with your paddle braced across both craft, as your buddy climbs back aboard.

Additional Skills

According to Safety Afloat, all persons participating in activities afloat other than during closely supervised instruction must be trained and practiced in craft-handling skills, safety, and emergency procedures. The skills reviewed above support Kayaking BSA requirements and prepare Scouts for kayaking on flat water of limited extent, such as that at a camp waterfront, and for float trips on flat water provided all facets of Safety Afloat are in place. However, ocean and river trips require additional kayaking skills, such as the classic Eskimo roll, for dealing with waves and moving water. Such skills are best learned under the guidance of an experienced instructor. You will also need to develop the ability to “read” the environment. An introduction to moving water is provided in the next chapter.





Stand Up Paddleboarding

Stand up paddleboarding, stand up paddling, or simply SUP is a fast-growing paddle sport. Techniques for using a paddle while standing on a board grew out of surfing but are now used for flat water and rivers as well. Although some of the basic mechanics of using a single-bladed paddle while standing on a board are similar to those while kneeling in a canoe, stand up paddling is different from canoeing and has its own unique characteristics and devotees.

There are several variations to stand up paddling, including short excursions on local ponds, traveling along the shores of large lakes, flat-water racing, river running, and ocean surfing. This chapter provides a brief introduction to basic flat-water safety and skills.



Equipment

Paddleboards Paddleboard designs vary based on their use. Stability is a basic need for beginners and depends on the width, length, thickness, and shape of the board as well as the size of the paddler. Although lengths vary from 7 feet to 16 feet or so, beginner boards should be 10 to 12 feet long and around 30 inches wide.

The front of the board is called the **nose**, the back is the **tail**, the top is the **deck**, and the sides are **rails**. Boards have one to three **fins** on the bottom near the tail to aid tracking (going straight).

Typical boards are rigid and are made of resin-saturated fiber over a foam core. However, there are also inflatable versions that are stiff enough for many uses and easier to transport. Boards made from wood are also available.

Paddles SUP paddles are made of various materials such as fiberglass and carbon fiber. They are longer than canoe paddles and need to be strong to withstand the extra torque. However, they should also be light in weight. Most paddles have the blade angled slightly forward.

As a rough guide, the paddle should be 8 to 12 inches taller than the paddler, based on usage and personal preference. When the blade is immersed in the water and the shaft is vertical, the grip hand should not be higher than the shoulder. Some paddles are adjustable for paddlers of different heights and break down into two pieces for easier transport. Two-piece paddles are also handy as spares on extended trips.



Life jackets The U.S. Coast Guard considers paddleboards as vessels when they are used outside of designated swim areas or surfing zones. Therefore, federal regulations concerning life jackets, sound devices, and lights apply. BSA Safety Afloat policies require life jackets to be worn by all participants during Scouting paddleboard activities. Positive flotation Type III jackets are recommended for all participants, although inflatable life jackets are appropriate in calm water for those 16 years of age or older.

Whistles Federal rules require all vessels to carry a sound-producing device. A whistle attached to a life jacket is appropriate for paddleboards.

Leashes A leash can be a crucial piece of equipment in numerous situations. Surfers use straight leashes to prevent losing boards when falling in waves. A leash for a paddleboard is also useful on calm water because even a slight wind can blow your board away faster than you can swim, particularly while holding a long paddle.

For flat water, a coiled leash is generally appropriate. One end is attached to the leash plug on the tail of the board and the other to a Velcro ankle or thigh cuff.

Leashes are also useful in rivers but can lead to entrapment in moving water and white water. Leashes for moving water and white water may be attached to life jackets with a quick-release mechanism. Seek additional guidance and training before using a paddleboard in moving water or white water.

Clothing Shoes are needed in most environments to protect your feet when getting on and off the board. Neoprene booties and wet suits are useful in cooler waters. A hat and sunglasses provide sun protection.

Learning to Paddle



The skills needed to stay upright and move about on a stable paddleboard in calm water are not difficult to learn. The basics are covered below. However, like kayaking, canoeing, or other boating activities, you will learn faster and better with coaching from a knowledgeable instructor.

The **BSA Stand Up Paddleboarding** award is a good way to begin. Scouts and Venturers should check with their Scoutmaster or crew Advisor for course opportunities. Unit leaders should check with their council service center or council aquatics committee to find qualified volunteers to teach the course.

The American Canoe Association also offers SUP skill and instructor courses.

Board Positions



The prone position is like that used by surfers without a paddle. It is a good safety position for stand up paddling if you have problems with balance due to waves or if you lose your paddle. Use your arms for propulsion as you lay face down on the board.

You can move to a kneeling position by straddling the board with your legs, moving forward or backward to balance the board front to back, and then pulling your legs up to sit on the board.



Kneeling is another good safety position. This position makes it easier to see where you are going than when in the prone position and you get to use your paddle.

Kneeling is also a good way for beginners to get a feel for the board before standing up.



Before standing up, find the balance point and then lay your paddle across the board. Stand up one knee at a time.



Stand with your feet about a foot apart, with one foot one to two inches forward of the other, and keep your knees slightly bent.

Forward Stroke

Grasp the paddle with the blade angled forward. Your lower hand is on the same side as the paddle. Your opposite hand on the grip crosses over the board above and toward your lower hand so that the paddle stays close to a vertical plane running along the side of the board.

Reach forward by rotating your shoulders to plant the blade next to the board. This is called the catch.

Pull the board toward the paddle blade. This is the power phase. Keep the blade close to the board to reduce the tendency of the board to turn away from the paddling side. Generate power by rotating your torso rather than pulling in with your lower elbow. Your lower arm stays comfortably straight throughout the power phase of the stroke.

Before your lower hand reaches your hip, angle the blade out of the water to begin the recovery.

As you swing the blade back to the catch position, rotate your wrists to slice the blade through the air nearly parallel to the water. This is called feathering and reduces wind resistance.

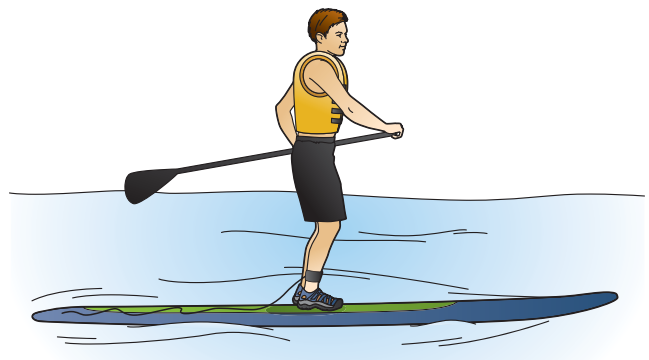

Going Straight

During the forward stroke you should be watching where you are going rather than looking at the paddle. After a few strokes on the same side, you will notice you are starting a wide turn away from your paddling side. The easiest way for beginners to go straight is to switch sides every few strokes.

As you gain experience, you can add a gentle course correction at the end of your stroke. Standing slightly toward your paddling side will lower the rail and may also help you track straight.



Turning and Stopping

To do a wide turn, keep paddling on one side with the blade farther away from the rail during the power phase of the stroke. For a sharper turn, follow a forward stroke with a reverse, or back, stroke on the opposite side of the board. The back stroke is also used for stopping.



Beyond the Basics

There are additional strokes and maneuvers to learn after the basics. For example, a sweep is more efficient for turning than a back stroke. During a sweep, the blade is swept in an arc away from the board. A forward sweep turns the board away from the paddling side. A reverse sweep turns the board toward the paddling side. Stepping back during the turn will raise the nose and make the turn even faster.



Falls and Recovery

Try to anticipate and avoid situations that may lead to a fall. For example, if a motorboat with a large wake approaches from a distance, you may want to kneel until the waves arrive and die down.

However, sooner or later you are going to fall. If you feel yourself losing balance and cannot easily recover by bracing with your paddle, try to fall feet first away from the board with your paddle held to the side.

To recover, approach the board from the center and, using the hand well, pull/lift yourself up over the rail and onto the deck, then slide around into the prone position. Unless there is a strong current, you can let your paddle float next to the board and retrieve it after you get on.

Other Safety Concerns

If you apply Safety Afloat concepts to stand up paddleboarding, you will anticipate and avoid most hazardous situations for safe flat-water paddling. Always wear a life jacket and paddle with a buddy in a safe environment for which you possess the necessary skills.

Seek further instruction prior to paddleboarding on rivers or in the surf.

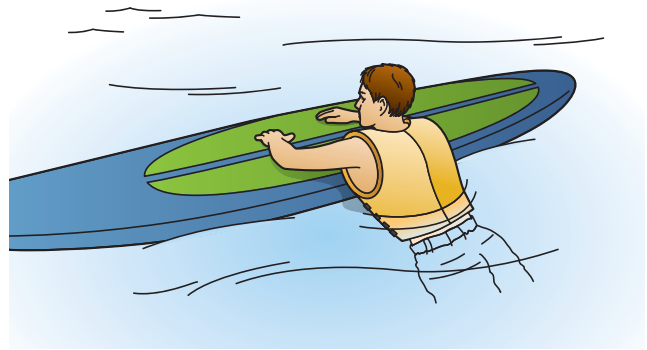

Acknowledgment

Thanks to the American Canoe Association for reviewing this material, helping with the BSA Stand Up Paddleboarding award, and providing photos from the ACA *SUP Survey Report: 2012 Lifejackets – Leashes – Legislation*.





Paddling on Flowing Water

River paddling has several allures. Drifting down a river with the current is much easier than fighting a strong headwind on a lake. Running an obstacle course over small drops through a boulder garden adds thrills and challenges. However, safely meeting the challenges of moving water requires knowledge and skill. Basic flat-water skills provide a good foundation but are not sufficient for river paddling.

River Basics

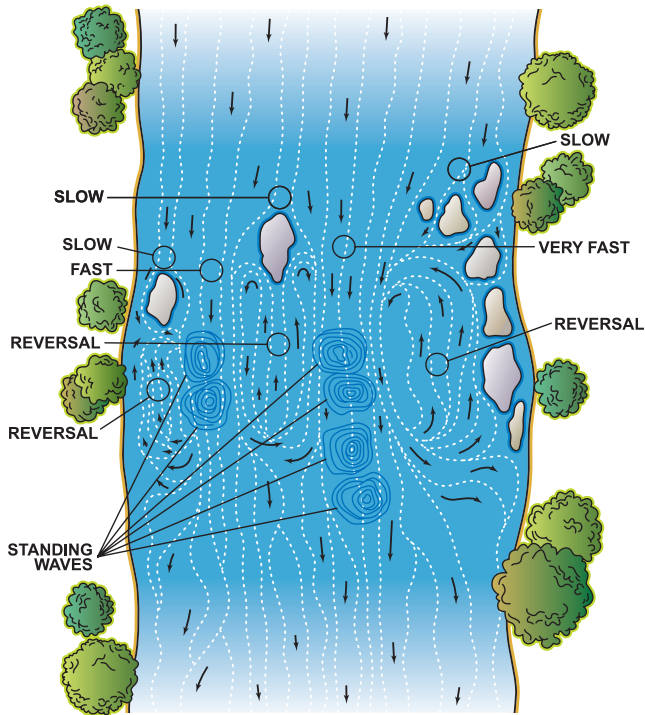

All free-flowing rivers have currents, but not all rivers have the drops and obstacles that create whitewater rapids. There are many more miles of rivers navigable by small boats without rapids than there are with white water. Therefore, we'll begin with currents. The strength of a current depends on the amount of water and the speed. The amount of water changes with seasonal runoff and can increase rapidly due to upstream rainfall or convergence of tributaries. The speed of the current for a fixed amount of water varies with the width and depth of the channel and the **gradient**, that is, how much the river bottom slopes downhill. The flow of a broad river constricted into a narrow canyon speeds up. The speed of the current slows down exiting the canyon onto a flat, broad plain.

The shape a river takes depends on the total flow and local geology. Forces within the earth raise mountains, but rivers shape the land and eventually move material from the mountains into the sea. Competent river paddlers know how to read a river, and reading a river is easier if you understand some simple geologic concepts of **fluvial** (river) systems.

In mountain country, water cascading downhill erodes weaker rocks to form channels. The channels tend to be steep and narrow with abrupt drops, and that leads to white water. Eventually, the rivers form wide valleys and wear the land into broad plateaus or plains. Rivers in valleys or on the plains continuously rework the soils and sediments they have deposited in previous ages. The channels are not straight conduits to the sea, but rather twist and turn or **meander**. In steep valleys, the meanders are gentle curves. On flat plains, meanders can form large, complicated loops. Each meander has a cutting edge that erodes sediments. The curve cuts through the land and becomes tighter. Eventually, high water during floods will break through the neck and temporarily straighten the river. The process then starts over. In flood stage, water extends from bank to bank, or beyond. In low water, the flow may break up into several different channels, each meandering within the overall width of the riverbed. Rivers nearing the sea may also divide into numerous smaller channels, with the current switching direction depending on the tide.

The meander process has important implications for the boater. As the river switches from one curve to the other, there will be short stretches of relatively straight channel. In a straight channel, the fastest current is in the middle. Because faster currents erode quicker than slower currents, the deepest water will also be near the center of a straight channel. In a curved riverbed, the fastest current and deepest water will be on the outside of the bend; the current on the inside of the bend will be less. Larger sediment particles fall out of suspension as the current slows, so the inside curves of a river often have shallow sandy stretches that make good launching and landing sites.

In low water, you will want to travel in the channel to avoid grounding or hitting the bottom with your paddle. That means you will travel from one side of the river to the other to stay on the outside of the meanders. Cutting across a bend near the inside bank might be shorter, but you normally will make better time if you stay in the current. If the river splits into several channels, follow the one that seems to have the greatest flow.

If you find yourself on a river with the water rising, you may wish to avoid the main current while looking for a safe place to take out early. In that case, stay toward the inside of a curve, and toward the bank rather than in the center of straight stretches.

Strainers

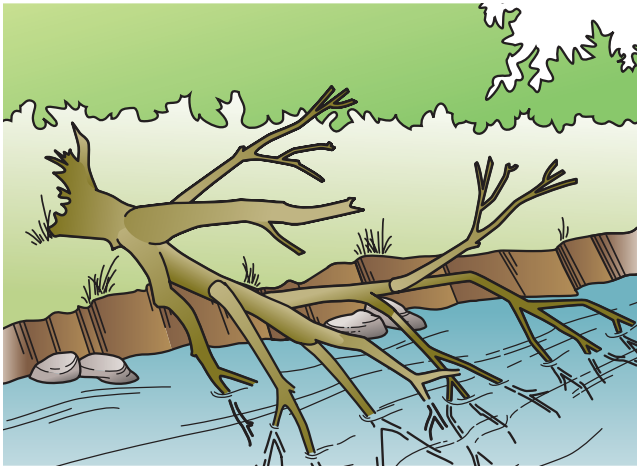

Trees often grow along rivers, even on the plains. As the meander cuts away the bank along the outside bend of a river, trees fall and become lodged across the strongest current. These **strainers** or **sweepers** can pose significant hazards to the paddler. Look well ahead for strainers, and be particularly careful coming around tight bends where visibility is limited. If there is a strainer ahead in the main current, then hug the inside of the bend to avoid it. Stop and scout if there is any doubt of getting around the obstruction. Although many strainers are located near the cut bank, floods can dislodge trees and move them just about anywhere. Some can be hiding just under the surface. Avoid any branches sticking out of the water.

Undercut Cliffs

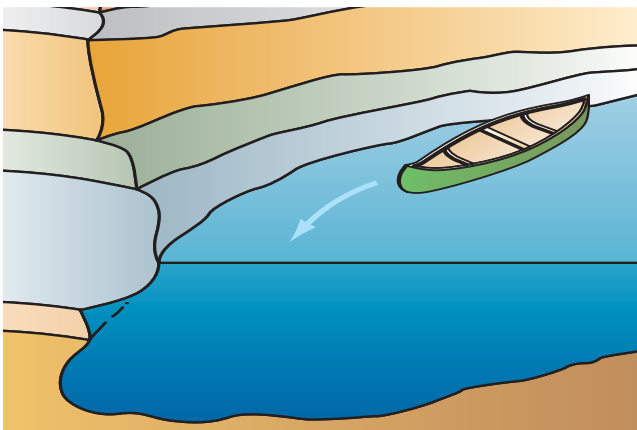

If the cut bank is formed from rock rather than soil, erosion will be slower, and meanders tend to have less curvature. However, erosion still occurs. Scouring over the years will cut into the rock below the waterline while leaving the cliff face above the waterline intact. Different rocks erode at different rates, so the profile of the bank may vary above and below the water. In some rivers, bottom

erosion will match or exceed erosion to the side, and you may be able to drift along in the shadow of an overhanging cliff. However, in other rivers, particularly at normal or high water flows, underwater currents may sweep in an undercut channel just below the surface. Such features may be invisible from above and can be very dangerous if a boat is swept underwater. Because such hazards may not be apparent from the surface, be leery of strong currents against rock cliffs and check river guidebooks and others who have traveled the river before. If the river is not wide and slow enough to avoid the undercut bank, the area should be portaged.

Low-Head Dams and Horizon Lines

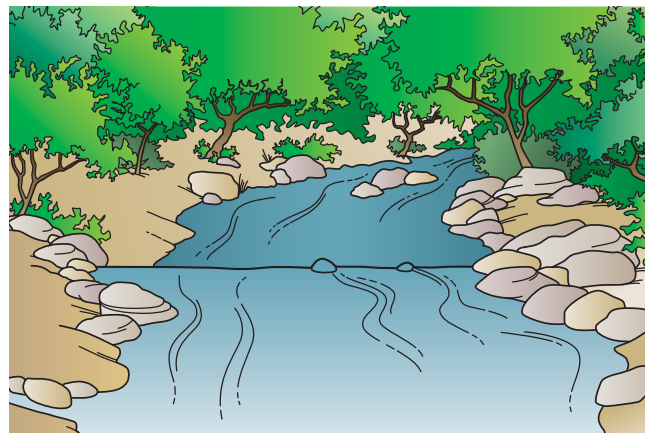

Many smaller rivers have low-head dams or weirs stretching in a level line from one bank to the other. The river falls evenly over the structure and often creates an extremely dangerous recirculating flow, or **hydraulic**, at the foot of the dam. These are aptly called “drowning machines” and should never be run. Identify any dams during trip planning and make sure each can be safely portaged. When on the river, look well ahead for a **horizon line** indicating you are approaching a low-head dam (or waterfall). The abrupt drop in river level below a low-head dam makes the river appear to disappear momentarily beyond the level horizon line across the river.

Current Measures

The total amount of water passing a point in a set time is measured in cubic feet per sec (**cfs**). River flows are often reported daily in newspapers and on newscasts, particularly for rivers where the flow depends on dam releases. Other rivers have gauges that measure the height of the water relative to some datum. Neither a flow report nor a gauge reading by itself will tell you if there is sufficient water for an enjoyable float trip, or too much water for a safe trip. A large river at low levels may flow several thousand cfs; the same level in a smaller river would indicate a major flood. Check river guidebooks for sources of flow information for specific rivers and suggested safe levels, and note the level during any trip you take for future reference.



If you suspect the water is rising during a float trip, take a short break onshore and note the level by placing a rock or stick at the river's edge. If the water covers your gauge after a few minutes, it's time to consider your alternate takeouts. If you are spending the night on the river, set up a makeshift gauge and check it in the morning.

The most important thing to remember in river paddling is that moving water has tremendous, unrelenting power. Suppose a canoe in a current strikes a rock and comes to a sudden stop. Since energy increases with the square of the speed, the energy required to stop the canoe from 5 miles per hour will be four times that at 2.5 mph, even though the speed only doubled. However, the energy also depends on the mass. The impact on a rock of an empty canoe drifting at 5 mph is about the same as dropping the canoe on the rock from a height of 10 inches—not something you want to do, particularly on a sharp rock, but the canoe will likely survive. Now swamp the canoe so it is drifting along full of water. The impact on the rock will now be similar to dropping an empty canoe on the rock from 28 feet. You don't want to be between a swamped canoe and a rock any more than you want to try to catch an empty canoe dropped from a two-story building.

You can also get a feel for the power in moving water by comparing it to the power in moving air. Water weighs 770 times more than air, so water flowing at only 3 mph has roughly the same energy per cubic foot as a hurricane-force 80 mph wind. Put another way, standing on top of a car traveling at 80 mph would be very difficult (and extremely foolish). Standing neck-deep in a 3 mph current would be about as hard.

Also note, however, that how you position yourself influences your interaction with the wind or the current. Point a closed umbrella into a wind, and the force on the umbrella is small. Open the umbrella pointed into the wind and the force increases significantly, but not as much as it would if you opened the umbrella to catch the wind. The same applies to a boat in a current. Point the boat with the current, and the force will be less than with the boat turned sideways to the current. If a swamped canoe is snagged by a strainer with gunwales facing downstream, the force will be less than with the gunwales facing upstream.

Sideslips

Most of the time, you should keep the canoe parallel to the current and make course adjustments by moving the canoe sideways. In a solo canoe or kayak, use either a draw stroke or a pry. In a tandem canoe, one person does a pry while the other does a draw. Sideslips are used to align the boat to pass between bridge pilings, to follow the channel in shallow rivers, and to avoid obstacles such as a submerged tree lurking just below the surface.



Do not attempt to avoid an obstacle at the last minute by using sweeps to pivot or otherwise turn the boat across the current. If you do hit a hidden object with the boat parallel to the current, chances are it will be a glancing blow and you will be able to continue on your way. If you turn sideways to the current just above an obstacle, you will likely **broach** and become pinned with the current pushing both ends of the boat around the object. It doesn't take much current to bend a canoe in half. If a broach appears unavoidable, try to lean the boat toward the obstacle so that the current will flow around the bottom of the hull rather than against a kayak deck or into a canoe between the gunwales. Your first concern, however, is to avoid being trapped between the boat and the obstacle. If the boat does not quickly slide past the object, get clear of the boat, fast, either by climbing on top of the obstacle or by swimming to the side.

Tandem canoeing in a river requires teamwork. The stern paddler is sometimes in a better position to make general course corrections, but the bow paddler is more likely to first notice an obstacle just below the surface. Clear verbal communication is a must, but a team used to paddling together will automatically take cues from each other. For example, if the bow paddler begins a draw or a pry to avoid an object, an experienced stern paddler should automatically perform a matching stroke to move the boat sideways.



Gate Test: The Scout gate test shown in the **White-water** merit badge pamphlet is not a substitute for experience on moving water but does help develop the quick, automatic skills needed to quickly move a boat sideways, forward, and backward without deliberation. It also develops teamwork between tandem canoeists. The course shown is done between poles or floats 4 feet apart. Strive to complete the course in less than 160 seconds without touching the markers.

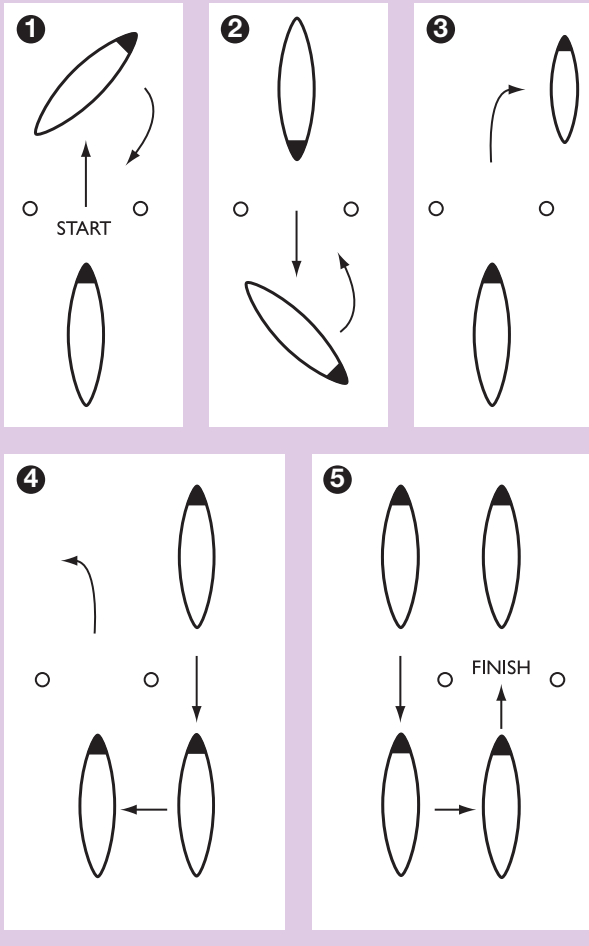

Ferries

River paddlers strive to use the power of the current to their advantage, rather than trying to work against it. One such strategy is used to cross from one side of a river to the other. You can move across a current with draws and pries while drifting downstream. That keeps your craft parallel to the current, which is good, but you'll travel a long way downriver before you make it all the way across. You might be tempted to strike straight across, but that will turn your boat broadside to the current and you will still sweep downstream. Alternately, you can stop near one bank, turn around, and paddle upstream at an angle with your bow pointed ahead of where you expect to land. The last maneuver is one version of a **ferry**, named for an analogous technique used by a barge connected to each bank with a rope or cable. To understand how a ferry makes use of the current, it's useful to look at the barge analogy.

A barge connected by pulleys to a line stretched across the river can be pulled across by grasping the rope. However, if the barge is set at a slight angle to the current, the water itself will help move the ferry from one side to the other. Current striking the upstream side of the barge pushes it sideways as well as downstream. Tension in the rope cancels out the downstream portion, and the remaining force will move the barge across the current without the ferrymen pulling on the rope. (There is a counter force at the narrow end of the barge, but it is smaller than the force on the long side.) To move back to the other side, the ferrymen reverse the angle to the current. The upstream end is always angled toward the opposite bank in the direction of desired travel.

If a canoe or kayak is paddled upstream with the bow angled slightly toward the opposite shore, the current will provide the sideways force while the paddlers substitute for the rope. If the paddlers are able to match the current in strength, the boat will slide across like the barge. More likely, there will be downstream drift, but not as much as if paddling straight across. A larger angle speeds the crossing but also results in more slippage. In tandem boats, the person in the stern holds the angle with pries and draws while the person in the bow attempts to hold position with forward strokes. A solo paddler has to maintain the angle while also moving against the current.

A downstream ferry is done with the boat facing downstream, but with back strokes used to counter the current. The stern is angled toward the opposite bank.

Note that it is the angle of the boat to the current, not to the shore, that determines the ferry angle. Also note that ferries are more difficult if the upstream end is trimmed lower than the downstream end. An unbalanced boat will work like a weather vane with the deep end swinging downstream.

Fast or Slow?

During upstream and downstream ferries, the boat is slowed relative to the current. Some strokes depend on the boat moving either faster or slower than the current. If you are moving along at a good pace on flat water and set the blade as a rudder at the end of a stroke, the boat will quickly veer to one side or the other. If you hold water to stop the boat, it slows rapidly. If you are drifting with a current going at that same speed, a set rudder angle

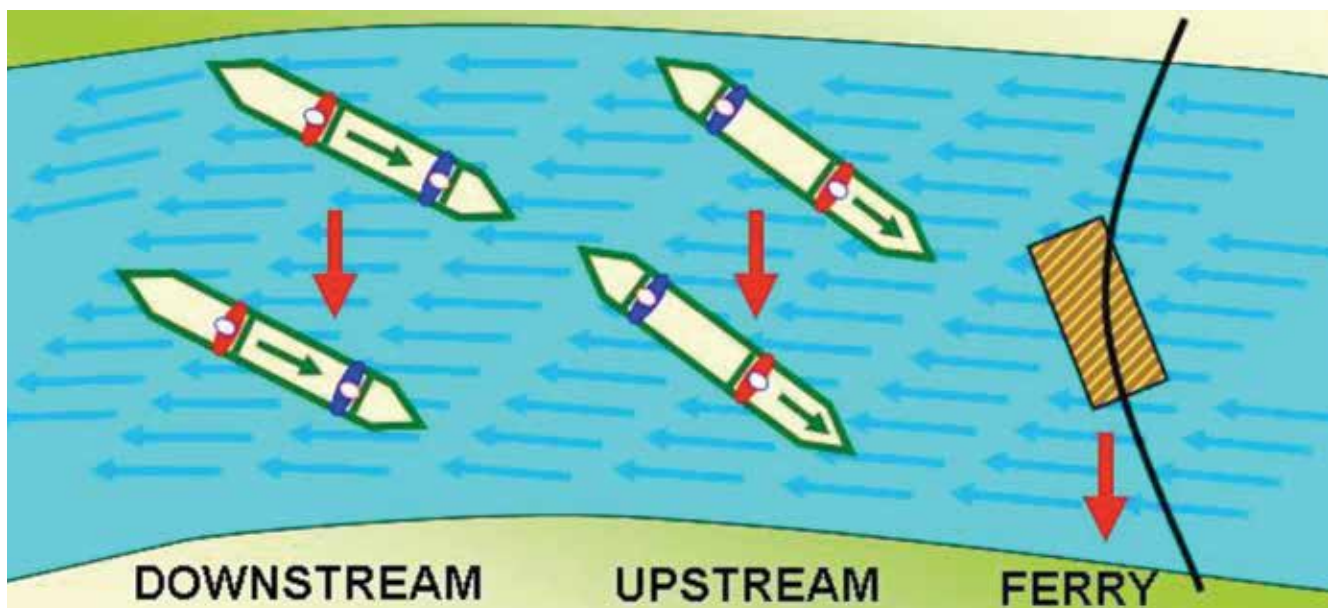

won't work and holding the paddle vertically fixed to the boat won't slow you down. Changes in motion require acceleration, that is, movement of the paddle relative to the water. In the flat-water case, you deflect water by holding the forward-moving blade against the resistance of the stationary water. When drifting with a current, the same actions don't work since the boat, paddle, and water are all moving together. If you paddle faster than the current, then the rudder and holding water will again work as expected. If you are moving slower than the current, then holding the blade fixed relative to the boat works as it would if you were backing water.

Moving faster than the current is naturally accomplished using forward strokes and helps maintain control of the boat. However, moving slower than the current, as in the ferries, is also a valuable option and can provide additional time to react in tricky situations.

Eddies

Any fixed obstacle blocks the current and creates a "shadow" zone immediately downstream. Water flows sideways from the deflected current to fill in the shielded region. If the obstacle is wide enough, water will actually flow upstream for a short distance. The area of reverse flow is known as an **eddy**, and the boundary between downstream and upstream flow is called an **eddy line**. Boaters crossing an eddy line unawares risk capsize as the opposing currents carry the bow and stern in different directions and the boat pivots.

Whitewater paddlers make use of small eddies behind midstream rocks as rest stops and scouting locations. To do so, they need to develop precise eddy turns to quickly

move into a tight location. Paddlers on larger rivers without obstacles are more likely to encounter eddies on the inside of tight bends, behind weirs extended partway into the current, or behind bridge pilings or other artificial structures. In most such situations, the eddies are avoided altogether by staying in the main channel clear of any obstacles. However, sometimes a takeout point may be at an eddy site.

To enter an eddy, the boat should be pointed toward the upstream start of the eddy line at roughly a 45-degree angle. As the bow crosses the eddy line, it will automatically turn upstream as the stern continues downstream. Paddlers should drive the boat into the eddy as it pivots. A paddle blade planted on the upstream side of the bow will make the boat pivot faster. The bow person in a tandem canoe can use either a draw or a cross draw stroke, depending on the paddling side. This is a **stationary** draw. The object is to catch the upstream current with the blade—it is not necessary to pull against it. The paddler should be ready to hang on. The boat is leaned upstream into the turn.

You can slip out of a broad eddy near its tail to continue downstream. However, a broad eddy in a river free of rapids is a good place to practice some skills needed for white water. Try a **peel-out** with the boat facing upstream. Drop downstream a bit against the eddy and align the boat facing upstream with the eddy line. Drive the boat forward to cross the eddy line at an angle. A bow paddler uses a stationary draw to pull the bow into the current as the boat pivots to head downstream. The boat is leaned downstream into the turn.

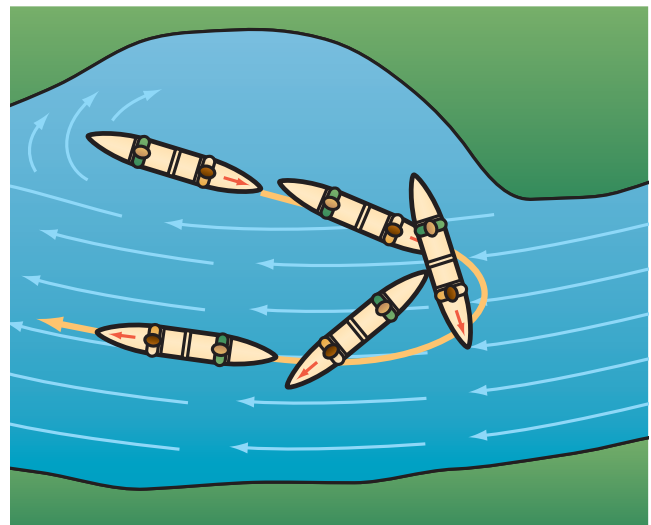
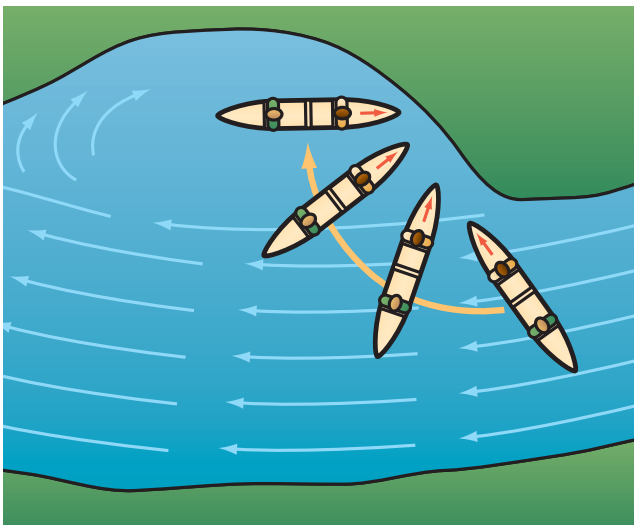

River Signals

The lead boat on a river trip should contain experienced paddlers who, ideally, have traveled that particular river several times before under different water conditions. The boat next in line should follow the path of the lead boat and make sure the boat behind does the same, unless the lead boat signals otherwise. Standard river signals using paddles have been developed so that information from the lead boat can be clearly communicated to boats behind. Review these signals at the start of the trip. Caution those in the group to avoid pointing at hazards. That is too easily mistaken as indicating a direction to proceed.



Self-Rescue



Everyone on a river trip needs to know how to react to a capsize in moving water. If feasible, stay with the swamped boat. It provides support and will be easy for rescuers to spot. Stay at the upstream end to avoid being caught between the boat and an obstacle. Slowly swim the boat to the side while waiting for another boat to provide a tow.

Do not jeopardize personal safety in an attempt to retrieve gear. Swim for shore if:

- You have been thrown clear of your boat.
- The water is very cold.
- You are approaching rapids or other hazards.

In deep water free of obstructions, swimming a fast forward stroke is feasible if the water is cold and the distance short. However, in shallow water, or in water with obstacles, swim on your back with your feet and legs pointed downstream near the surface. Swim backward to ferry toward shore or to avoid obstacles.

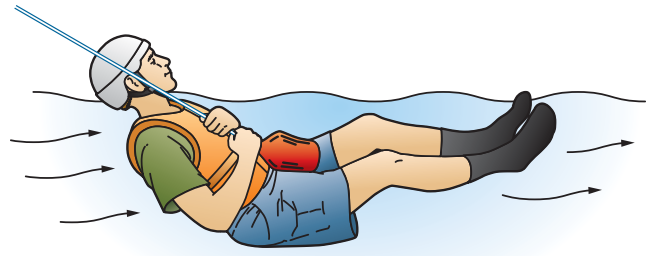

If thrown a line, float on your back, feet downstream, with the line over your shoulder and held to your chest. Do not attempt to pull yourself along the line. Instead, swing with the current toward shore.



Do not attempt to stand in shallow water above your knees. If your foot becomes wedged between rocks on the bottom, you may be unable to keep your head above water against the force of the current.

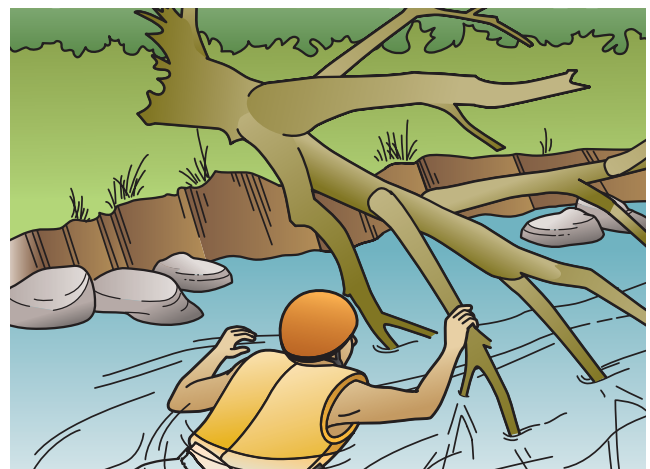

If you are being swept toward a strainer, change from the feetfirst position on your back to a headfirst position on your stomach with your head out of the water and your legs at the surface. Try to climb onto or over the strainer instead of getting sucked underneath.

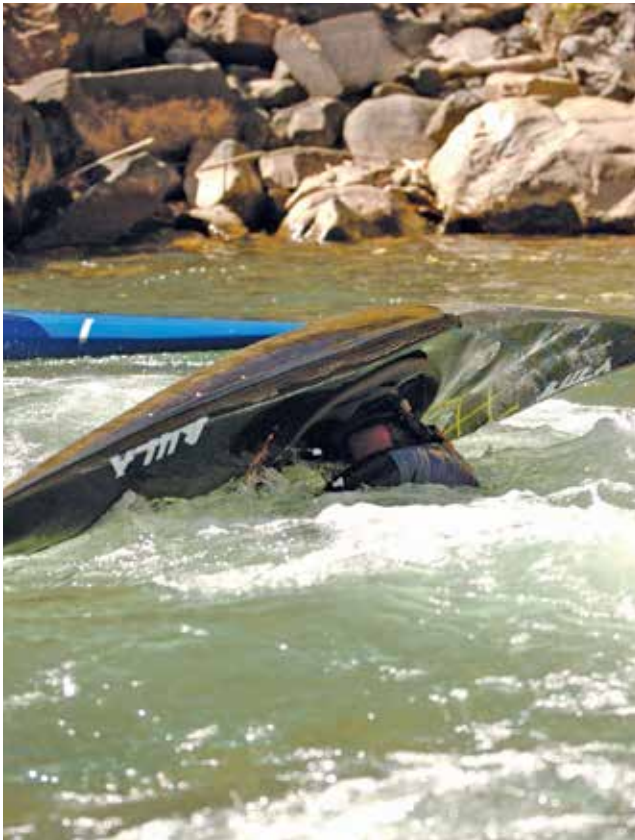

Boat Assists

If your buddy boat capsizes ahead of you in a current, first look for an obvious cause. You may need to maneuver around a submerged obstruction to avoid swamping yourself. If so, pick up swimmers after they float clear. Quickly check to see that paddlers are conscious with their heads above water. A kayaker needs to either exit the craft or perform a roll. Next, look ahead for other possible hazards and decide whether to approach swimmers from the left or the right. In unobstructed water, have swimmers hold onto the ends of the rescue boat as you ferry toward a safe landing site onshore. You may need to drift downstream until a safe exit comes into view. Downstream craft should back water and position themselves to assist swimmers or retrieve loose gear. Everyone's first concern should be for the swimmers. Boats and other gear are secondary concerns.

If you have maneuvering room and the capsized boaters are drifting with their boat, you can slowly tow the swamped boat and the swimmers if they are able to hold onto your boat's grab loop or painter.

Throwing Assists

Boats that are significantly ahead of a capsized craft may have time to land and get ready for a throwing assist using a **throw bag**. A person setting up for a throwing assist should have secure footing, ideally above a good landing spot for the swimmer. If the bag is cinched shut with a plastic slide, make sure the top is open enough for the line to play out freely. Hold the bag in one hand and the loop in the end of the line in the other hand. Try to get the swimmer's attention by yelling "Rope!"

Throw the line while the swimmer is still slightly upstream. A good throw should lay the rope across the victim's chest, but you will need to allow for a moving target. Normally the bag is thrown underhand, but an overhand toss may be used to clear weeds near the shore.

If the river is free of obstructions and the shoreline is clear, the rescuer can walk downstream and inland to pull the swimmer toward shore without having to hold the swimmer against the force of the current.

If there is not an easy path along the bank, be prepared for considerable force if the line becomes taut. Additional rescuers can help hold the line. If necessary, belay the line around a stout tree or large rock. Let the current swing the swimmer toward shore. Alternatively, run the line around the back of your hips, and brace your feet in a wide stance. You should be able to release the line at any time, from yourself if you are about to be pulled in, and from the belay if the victim gets tangled in the line and needs it slack.

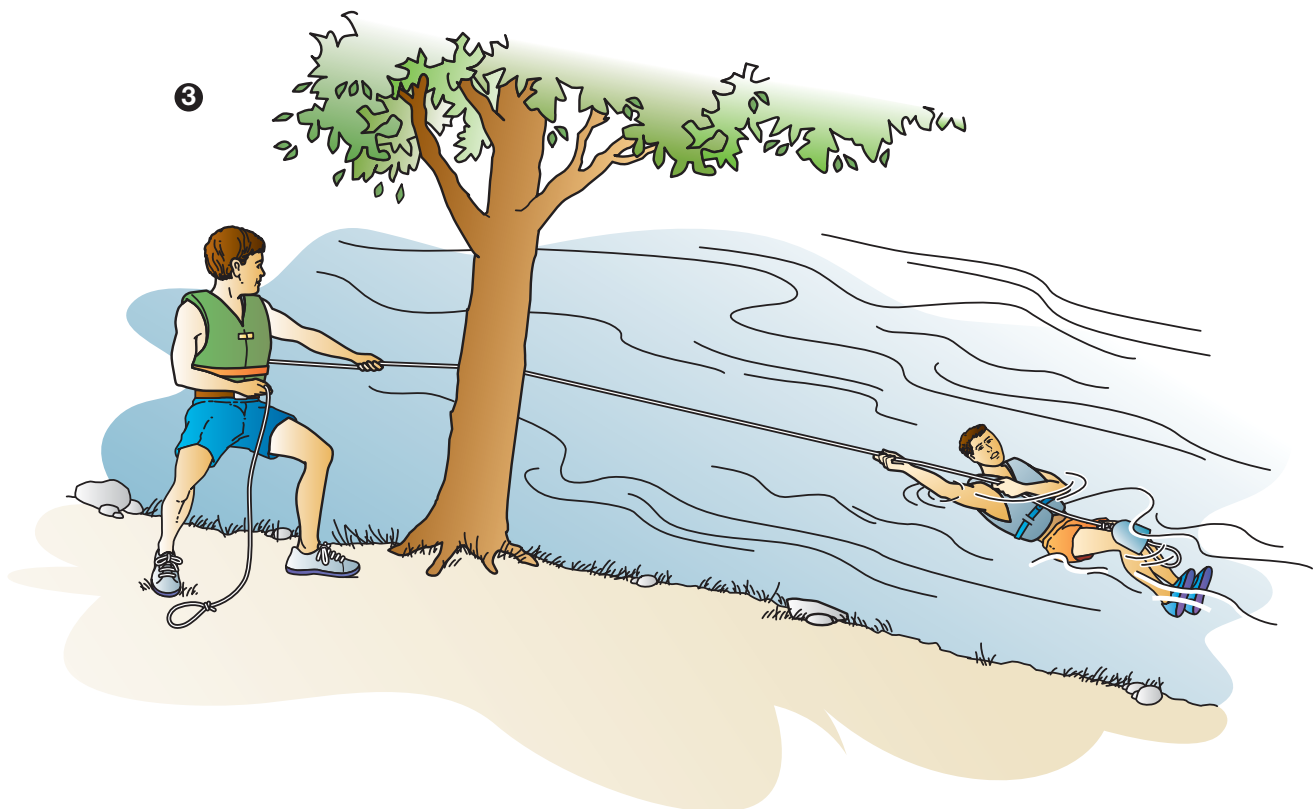

Tubing

Drifting down a shallow, lazily flowing stream on a warm, sunny day on tubes, air mattresses, or small rafts is a pleasant way to pass the time. Even though the activity is akin to swimming, once you leave the confines of a swimming area to venture down moving water, BSA Safety Afloat standards apply. All participants must pass the BSA swimmer classification test, wear a life jacket, and have a buddy close by. Make sure you know the water ahead and allow plenty of time to meet your float plan.

Ideally, the tubes should be designed for river floating, with concealed valves, a mesh or net cover, and grab lines. Be wary of exposed valve stems on inflated tire inner tubes. Auxiliary gear should include shoes, sun protection, and plenty of safe drinking water.

Tubes are generally controlled with the hands, although small fins or hand paddles may be useful. Canoe and kayak paddles are generally not worth the trouble—tubes tend to spin.

Since tubes are difficult to control, avoid all but the gentlest of currents (Class I as defined in the next chapter). If you want the adventure of white water, stick with a canoe, kayak, or whitewater raft.



Whitewater

Increase the gradient of a river with a decent flow; then throw in drops, exposed rocks, and constrictions, and whitewater results. Safety on flowing water requires additional knowledge and skill beyond those needed for calm water. Safe whitewater excursions require even more expertise, which is best learned in stages from a skilled, experienced instructor.

Closed V

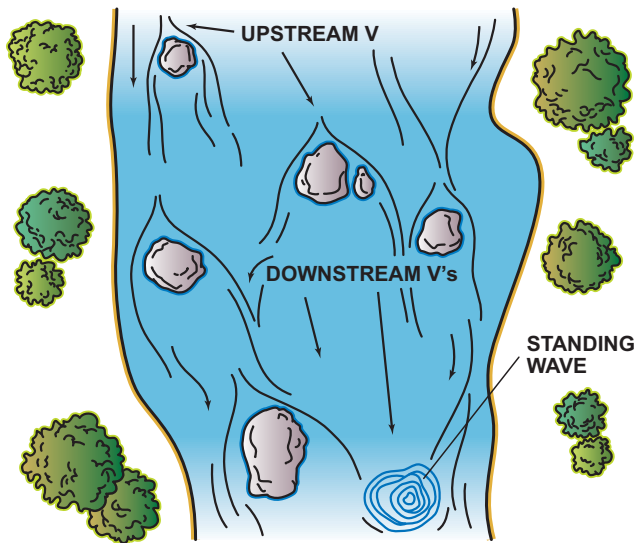

Add obstacles in a current, and reading a river requires an additional vocabulary. Note that many of these features will be easier to identify looking down on the river from a stationary point on the bank. They may be hard to spot from river level. A rock or tree near the surface will deflect water to the sides and produce a V shape in the water with the point facing upstream. Sideslip upstream of such a feature to avoid the obstacle and a possible broach.

Open V

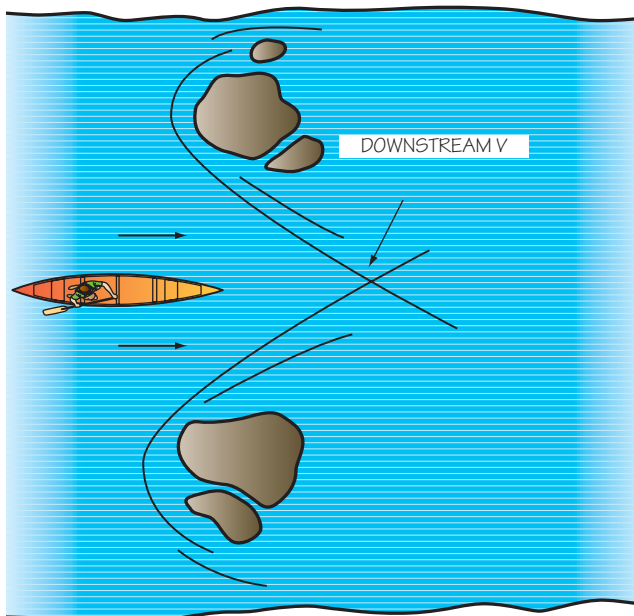

An open or downstream V forms between two obstacles such as isolated rocks or a break in a rock ledge. The wide end of the V is upstream and the point is downstream. Downstream V's often indicate the best route. Aim for the point, or just to one side.

Standing Waves

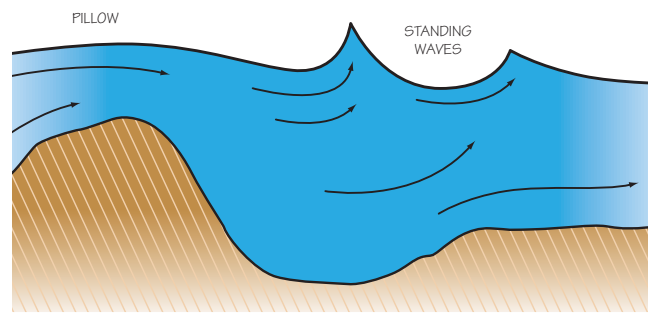

The faster water flowing in an open V will often produce standing waves, or **haystacks**, as it hits slower water downstream. Waves in a river are often caused by changes in flow rate, rather than by obstacles below the surface. A line of small waves just below a downstream V often indicates deeper water and a good route. However, if the waves are too large, particularly if they are breaking back upstream, you may need to avoid them, particularly in an open canoe.

Eddies

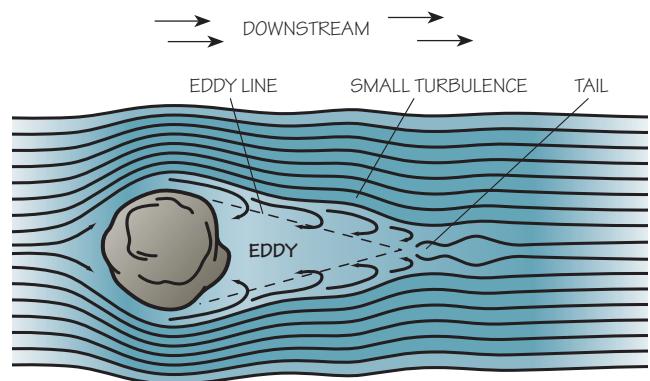

Any stationary object that protrudes above the surface will deflect current to the side and produce a counter flow as the water fills in behind the object. If the object is wide enough, the counter flow, or **eddy**, will be big enough to shield a boat from the downstream current. A popular strategy for running long rapids is to hop from eddy to eddy to rest and scout the next stretch. An **eddy line** separates downstream from upstream flow and must be crossed correctly to take advantage of the shadow zone behind the object.

Pillows and Pour-Overs

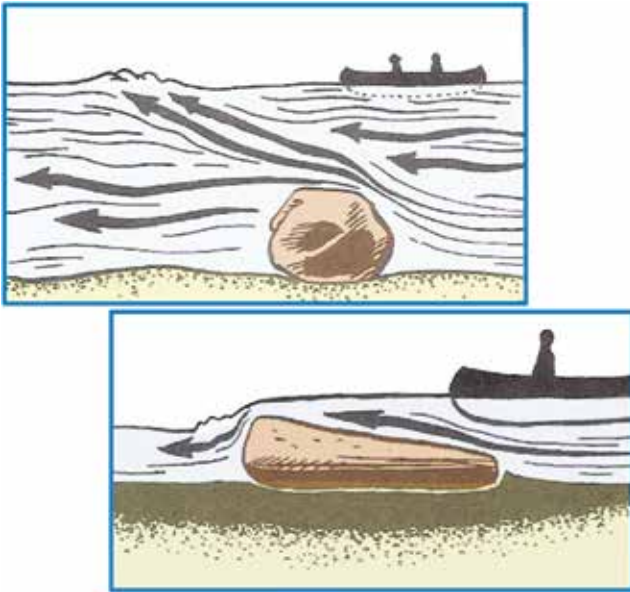

A deep rock in a strong current will produce a boil on the surface downstream of the rock. A **pillow** will form as water pours over a rock near the surface. Pillows, particularly over large flat rocks, can cause calm-looking areas in rapids and should be avoided. If the rock breaks the surface, the water piling against the upstream side will produce a pillow that will help push you away from the rock if you strike it at a glancing angle rather than broadside.

Holes

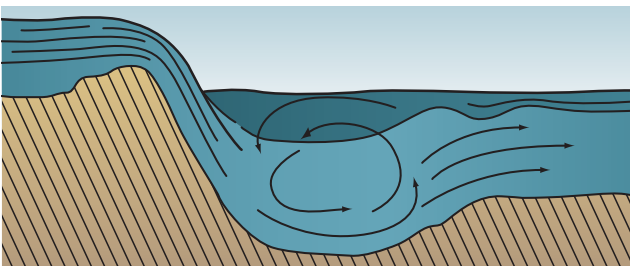

Given the right combination of rock shape and current strength, water flowing around and over a large rock just beneath the surface will create a depression, or **hole**, that is filled by a large standing wave that curls back toward the rock. Unlike eddies, holes should be avoided. If a break in a ledge or between rocks is accompanied by a steep drop, the water cascading down will also form a hole that is backfilled from downstream. Water pouring over an unbroken ledge can produce a dangerous hydraulic similar to a low-head dam.

Drops



Amazingly high sheer drops, or waterfalls, are run by experts in decked boats willing to take extreme risks. Scouting units should portage such features. Several rock ledges may create a series of smaller drops. These should be studied carefully from shore. Portage any situation where there is not sufficient space to line up the next drop after the first, or where an error anywhere in the series exposes boaters to an unacceptable hazard farther downstream.

Shoals



Rivers at low flows or with stretches where the channel is wide and shallow may have sections of “dancing” water or **shoals** caused by numerous small rocks near the surface. Stay close to the outside of river bends where the channel is deepest, and aim for any obvious downstream V’s. Be ready to step out of the boat if it drags bottom in very shallow water. Boats may be lined through short sections of shallow shoals, but be wary of tripping hazards and foot entrapment.

International Scale of River Difficulty

American Whitewater maintains the U.S. version of a river rating system used to compare the difficulty and risks of various rivers at different flow levels. Check out www.americanwhitewater.org for details. The scale is at best a rough estimate. Particular rapids may not fit easily into the categories, and individuals from different parts of the country may interpret the scale differently. However, a river purported to have numerous Class III to Class IV rapids should be more challenging than a river with mainly Class II rapids but a single Class IV rapid that is easily portaged. Therefore, the scale can be used to help decide whether to embark on a section of a river, but you should supplement the rating system with individual knowledge and detailed descriptions found in river guidebooks. Even then, keep in mind that a river may change from one run to the next, even if the flow is similar. Note that rapids at the lower or upper end of the range may have – or + designations. See the above website for the complete text of the classification scheme for Class V and VI.

Even though the Class I description seems benign compared with the others, don't forget that any moving water can be hazardous, particularly to those unprepared for currents and cold water. Floating a river at flood stage is not recommended regardless of wave size or obstacles.



Class I: Easy



Photo illustration

Fast-moving water with ripples and small waves. Few obstructions, all obvious and easily missed with little training. Risk to swimmers is slight; self-rescue is easy.

Class II: Novice



Photo illustration

Straightforward rapids with wide, clear channels that are evident without scouting. Occasional maneuvering may be required, but rocks and medium-sized waves are easily missed by trained paddlers. Swimmers are seldom injured; group assistance, while helpful, is seldom needed.

Class III: Intermediate



Photo illustration

Rapids with moderate, irregular waves that may be difficult to avoid and that can swamp an open canoe. Complex maneuvers in fast current and good boat control in tight passages or around ledges are often required; large waves or strainers may be present but are easily avoided. Strong eddies and powerful current effects can be found, particularly on large-volume rivers. Scouting is advisable for inexperienced parties. Injuries while swimming are rare; self-rescue is usually easy but group assistance may be required to avoid long swims.

Class IV: Advanced



Photo illustration

Intense, powerful, but predictable rapids requiring precise boat handling in turbulent water. Depending on the character of the river, it may feature large, unavoidable waves and holes or constricted passages demanding fast maneuvers under pressure. A fast, reliable eddy turn may be needed to initiate maneuvers, scout rapids, or rest. Rapids may require “must” moves above dangerous hazards. Scouting may be necessary the first time down. Risk of injury to swimmers is moderate to high, and water conditions may make self-rescue difficult. Group assistance for rescue is often essential but requires practiced skills. A strong Eskimo roll is highly recommended.

Class V: Expert



Photo illustration

Extremely long, obstructed rapids requiring precise boat handling in turbulent water.

Class VI: Extreme and Exploratory

These runs have almost never been attempted and often exemplify the extremes of difficulty, unpredictability, and danger.

Whitewater Gear

In North Woods lake country, long treks favor touring canoes even though the trip may include short stretches on rivers between lakes. Many seasoned canoeists easily take on Class I and Class II rapids without special gear, and some experts can handle Class III rapids in a long, open canoe full of gear. However, they are exceptions. Those seeking the challenges of white water should meet those challenges with boats and gear suited to the task. Whitewater canoes and kayaks have short, rockered hulls for easy maneuvering. Kayaks have small cockpits with spray skirts. Canoes have saddles and thigh straps rather than seats, and are filled with flotation. Hull materials are impact-resistant.



A strong, properly fitted helmet should be worn whenever upsets are likely in white water. Helmets are essential in any craft in Class III rapids or above, and should be used in kayaks and decked canoes for most river travel. The head of a paddler in an open canoe generally stays above water during a capsize, but needs a helmet for protection when swimming through rapids. A paddler in a kayak or decked canoe rolls head down, even if doing a wet exit rather than a roll, and therefore always needs head protection in rivers with rocks, shallow water, or other obstructions. Use helmets designed for white water; don't rely on a bicycle helmet to meet the need. Material should protect the forehead, temples, ears, and the base of the skull. Most helmets feature holes that allow water to drain. The helmet should feel snug but comfortable.



Paddling Skills

The basic skills needed for river travel were covered in the last section. Paddlers in any craft should be able to travel forward and backward parallel to the current and move sideways while staying aligned with the current. However, a boat in white water seldom moves in a straight line or even where it is pointed. Frequent turns occur at all angles to the current. Paddlers in white water need to perfect ferries, eddy turns, and eddy peel-outs. Various braces and stationary draws, both onside and offside, help with those maneuvers. Kayakers must learn wet exits with a skirt and need to perfect a roll in moving water if they expect to tackle rapids with higher ratings. Some of those skills are discussed in the **Whitewater** merit badge pamphlet and the BSA **Fieldbook**. Those will not be repeated here: Whitewater skills must be acquired through demonstration and practice rather than picked up by reading.



It is feasible for individuals or groups to move systematically from flat-water to whitewater skills. A day or two of instruction and practice on flat water with a competent instructor can safely be followed by a day trip on a Class I river guided by an instructor familiar with that run. Subsequent trips can be on more difficult sections of river. Some rivers are of the pool-and-drop variety with long stretches of Class I water interrupted by short, isolated rapids. The drops can be run multiple times to perfect skills without the danger of a mishap carrying a capsized boat into another hazard. Once the group learns the skills

in a safe, relaxed setting, more ambitious trips can be considered. That is a viable approach for a Scout troop or a Venturing crew with capable leadership to gain the skills needed for paddling at the Class II level along with an occasional Class III (-) challenge. Numerous rivers will fit those categories; there should be plenty of variety to keep the group engaged without the need for higher and higher skill levels. As new members cycle through the unit, they can be brought up to speed with more experienced youth without having to bar new members from unit trips because of skill level. However, other training options are available if unit leadership lacks basic instructional capability, or a Venturing crew really wants to tackle the nearby Class III to IV river.

Learning by doing is fine in concept, but can leave large gaps if the procedure is not systematically arranged by a knowledgeable leader. BSA units lacking internal resources may get useful assistance from local paddling clubs. Ideally, the local club will have volunteer instructors certified by the American Canoe Association or a similar organization. ACA instructors offer canoeing and kayaking courses from basic to advanced, from flat water to different levels of white water. The ACA also has courses for float-trip leaders. Check out the ACA website at www.americancanoe.org for course outlines and contacts with affiliated clubs.

Failing a local volunteer connection, there are many commercial paddling schools where a unit can obtain professional instruction to jump-start a whitewater specialty. Course location, duration, and price are all practical considerations in the choice of a paddling school. Also evaluate schools based on years of operation, type and condition of equipment, instructor training programs, and recommendations from other BSA leaders.



Whitewater Strategy

Even a properly trained and equipped group faces important decisions when deciding whether and how to run a particular rapid.

- **Know the river and the group.** Knowledge of the river and the skills and limitations of the group are important aspects of trip planning. Once on the river, that knowledge is used to gather the group at a safe landing above any feature that needs scouting from the bank. The only portage around a waterfall may be on one side above a turn in the river. Hugging the opposite cliff side until the horizon line becomes visible around the bend may not allow sufficient time to avoid the hazard. Proceed into a rapid only if it is known to be easily within the capability of everyone in the group at current water levels. Otherwise, stop and scout from the shore. Rivers where scouting can only be done on the fly from one eddy to the next are for experts only.



- **Scout intelligently.** Walk downstream along the bank until the end of the rapid is in clear view, that is, until a point is reached where everyone boating or swimming the rapid will be able to regroup and land if necessary to scout the next feature. Then look back upstream to determine if there are one or more points to safely exit the rapid. Visually work upstream of likely exits to connect clear paths around intermediate obstacles until you arrive at likely entry points to the rapid. Then consider the plausible routes indi-

vidually and discuss the pros and cons of each path as a group. In some cases there will be only a single viable path that does not require complex maneuvering beyond the group's capability. In other cases, there may be one easy route, and additional paths of increasing difficulty. Note that features clearly visible from a high bank may be difficult to see from water level. Safely running the rapid may depend critically on either lining up an intermediate chute or avoiding a dangerous hole. Look for landmarks, if any, that should be obvious on the water and factor those into the evaluation.

- **Decide.** Everyone in the group needs to individually decide whether they wish to run the rapid and, if so, which path to take. Different members of the group may have different preferences. No one should ever be pressured to run a rapid they view with concern. However, individuals may also overestimate their ability or discount the consequences of an error. For youth groups, adult leaders assume responsibility for the safety of those under their care and may elect to have individuals or the entire party portage a rapid that some group members would attempt on their own. The following questions will help individuals and leaders reach a reasonable conclusion.
 1. **Is there a safe path?** If there is an unavoidable steep drop into a hole, if there is not enough room between ledges to align one narrow chute with another, or if the only chute with sufficient water depth runs straight into a boulder, the decision is easy. Everyone portages.
 2. **What maneuvers are required?** Perhaps the paddlers need to sideslip past a rock near the point of a downstream V while negotiating moderate-sized standing waves. Maybe a short ferry is needed to align one chute with another, or perhaps an eddy needs to be caught to move from one side of the river to the other. Any course that moves across the current in short distances may require precise execution.
 3. **Does each person have the skills necessary to make those maneuvers?** If a solo kayaker or a tandem canoe team missed an easy ferry or eddy earlier, they probably are not ready if tighter moves are required for the rapid under consideration. The goal is to keep the boat always under control. Paddlers who rely on luck rather than skill to maintain control during specific maneuvers should opt out.



- 4. What are the consequences if the maneuvers are not successful?** A common result of a botched maneuver is that a paddler becomes a swimmer. No one should enter a rapid in a boat if they are unwilling to swim that same rapid in case of an upset. The risk to a swimmer often depends on where in a rapid a capsizing occurs. If the only critical maneuver occurs near the end of the rapid, the swimmer may simply be swept into a safe pool. If difficult maneuvers are required near the start of the rapid, the results of an error are more dire if the swimmer faces steep drops, holes, or undercut rocks. When calculating the margin for error, also consider the temperature of the water. Longer swims increase the likelihood of hypothermia. The other risk of a botched maneuver is the loss of a craft. Consider the chances of a boat wrapping around a rock for upsets in different parts of the rapid. Finally, consider the chances that a boater will be pinned in a craft.



- 5. Are the consequences acceptable?** This is the kicker. Risk to life and limb should always be minimized. But a swimmer swept into a deep pool after a short swim in warm water may only slow the trip

down a bit. In between the obvious are situations where the potential loss of gear and time are more inconvenient than hazardous. Remember that a float trip is meant to be an enjoyable experience. Just because you have planned ahead and can get everyone off the water safely doesn't mean that a lost boat is an acceptable risk. When in doubt, err on the side of caution. There will be other rapids where the group will have fun and gain experience.

Whitewater Rafting

Units without the training or gear to undertake a whitewater trip on their own have other options for catching the thrills and challenges of white water. Commercial rafting trips cater to people with limited experience. Short trips may take only a few hours. Other trips take a week or more. In oared rafts, participants are along for the ride. A professional rower maneuvers the raft through the rapids. In paddle rafts, riders participate by paddling under the direction of a trained guide at the stern. The rafts are large and stable and can handle heavy white water. However, realize that a raft ride on a wild river is not the same as an amusement park ride. Statistics compiled by American Whitewater show that commercial whitewater-rafting trips are not without risks, including fatalities. Even the largest rafts can flip and send passengers for a swim. Enthused paddlers on paddle rafts can inadvertently strike one another. The key to a safe, enjoyable experience is a competent rafting service.



Use the following criteria to compare rafting services:

- **Years of operation.** New outfitters may operate to the highest standards, but those who have been around awhile and still stay booked have a proven success record. However, experienced companies may hire inexperienced guides.
- **Safety record.** Operators are unlikely to share poor safety records but may use clear records in their advertising. Check various websites for additional information, including contacts with government regulators.
- **Condition of equipment.** Helmets, life jackets, rafts, paddles, food storage containers, and other equipment need not be brand new, but should be clean, functional, and up-to-date.
- **Safety policies.** Rafting services cater to the general public and therefore may not have guidelines as strict as those of the BSA concerning ages and swimming ability. However, there should be reasonable restrictions based on age and physical condition. Pretrip orientations should include proper fitting of helmets and life jackets, and what to do if knocked overboard or the raft flips. Overnight trips should include additional safety instruction relative to camping, communication, and first aid.
- **Guide training.** Some states closely regulate the rafting industry and require specific guide training programs that result in licenses. Other states simply require rafting services to post a fee. Therefore, phrases such as “state approved” or “trained guides” will have different meanings in different locations. Reliable operators should gladly share details of their guide training programs with prospective clients. Many do so on their websites. Check

first-aid training and emergency action plans as well as rafting credentials.

- **Instructional programs.** Some operators include natural history and ecology programs in sections of river between rapids. Many operate under permits that require ecological responsibility.
- **Alcohol policy.** Most serious whitewater enthusiasts agree that alcohol and other drugs are not conducive to whitewater performance or safety. However, a few groups see float trips as opportunities for binging, and some whitewater guides are known to indulge heavily when off the river. Even though Scouting trips should be alcohol-free, check a rafting company’s policy on alcohol use by participants and guides, particularly for overnight trips. Some limit alcohol to an evening meal; others restrict alcohol consumption to a post-trip party. Look for a company that enforces a policy of restraint.

Commercial rafting services are not solely of interest to those without whitewater skills. Access to some rivers is by permit only, which may take years to obtain. Commercial rafting operators may have access to permits through other avenues, which means a trip down some popular rivers is best arranged through an outfitter. Some will escort kayaks with support rafts.

Rafting tip: *Rafting guides EXPECT TIP\$!*



BSA High-Adventure Bases

Local council camps recognized by the BSA National Council offer an additional avenue for a BSA unit to undertake a whitewater excursion under proper supervision. Check www.scouting.org for a list of high-adventure bases and search for those that offer river canoeing, kayaking, and rafting.

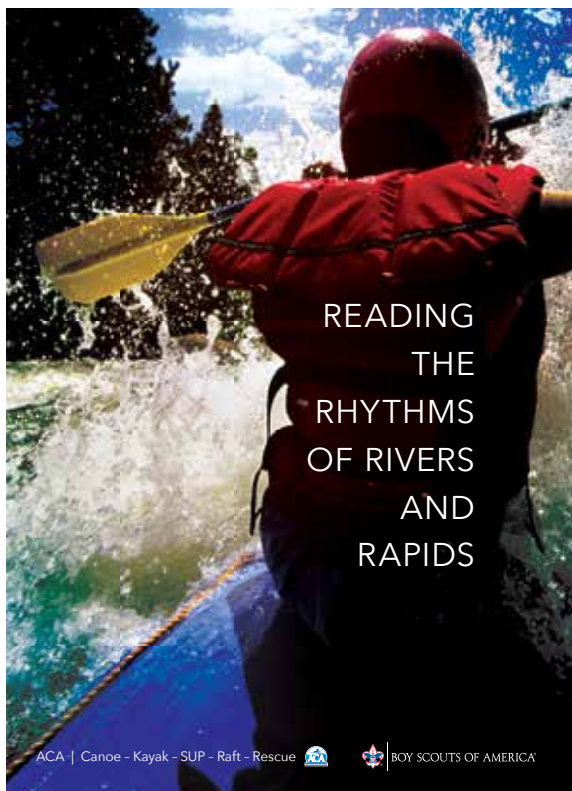

When combined with quality on-water instruction, this video should help paddlers understand the features and hazards of flowing water. Topics include:

- River primer
- Flow rates
- Flow types
- Paddling in uniform currents
- Going 'round the bend
- Flowing water hazards
- Whitewater features
- Whitewater classifications
- Scouting rapids
- When problems occur
- Trip preparation



BOY SCOUTS OF AMERICA
1325 West Walnut Hill Lane
P.O. Box 152079
Irving, Texas 75015-2079
www.scouting.org

ACA | Canoe - Kayak - SUP - Raft - Rescue
503 Sophia St., Suite 100
Fredericksburg, Virginia 22401
www.americancanoe.org

430-605
2016 Printing

Additional insights on river and whitewater features may be gained from the *Reading the Rhythms of Rivers and Rapids* DVD, a joint production of the ACA and the BSA, funded by a U.S. Coast Guard-administered grant. Each council should have copies.



Float Trip Preparation

“Where to go?” seems a logical first concern when considering a float trip, but several interrelated questions must be addressed together before the “where” can be finalized. Those questions include:

- Who will go?
- How long?
- What gear is needed?
- How is the gear obtained?
- How much will it cost?
- How to get there?

Because a trip is often triggered by a suggested location, we'll start there, and see how the other questions arise.

Researching a Location

Inexperienced parties should only consider trips accompanied by a leader who knows the route from firsthand knowledge. Ideally, a group will gain competence on short day trips before tackling an extended wilderness adventure. However, a skilled leader can guide inexperienced parties with adequate preparation. A group of older Scouts strong on camping but weak in canoeing can nevertheless enjoy the experience of a lifetime under the wing of an interpreter at the Northern Tier High Adventure Bases. **"Where?"** therefore depends on the experience of the leaders and the skills of the participants, that is, the **"Who?"**

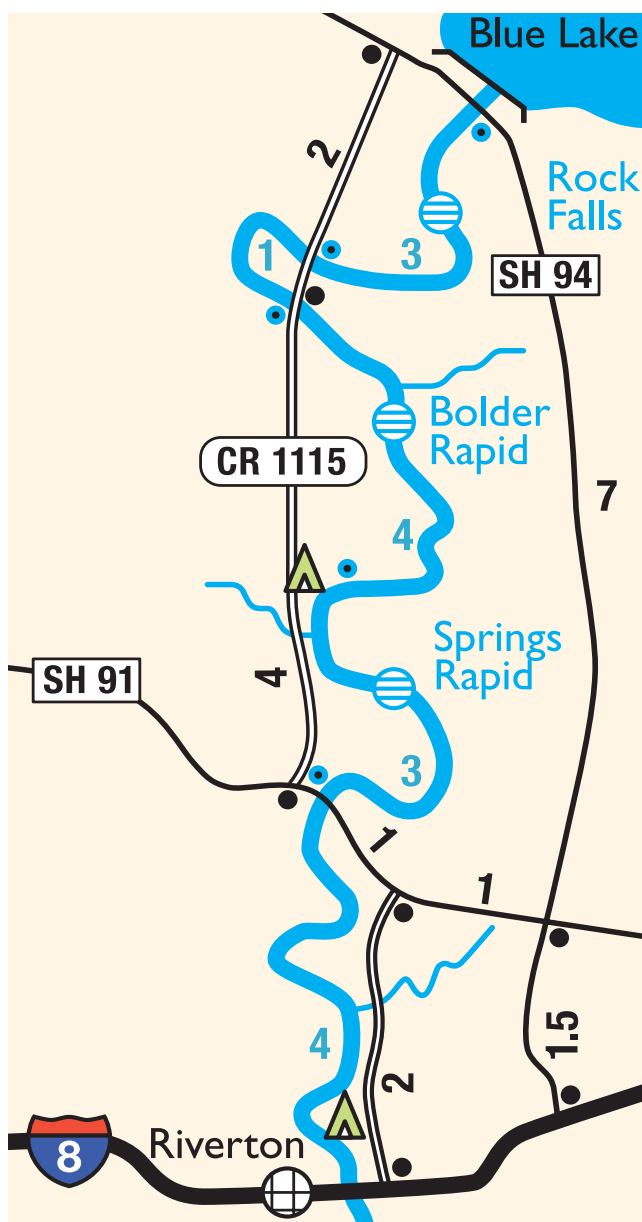

More-experienced groups can use river guidebooks to review potential destinations. Many guidebooks are rather obscure publications; the internet can be used to track down a written or online guide to a particular river. Do a search on a location by name or check the websites of the major paddle sports organizations, of paddle clubs near the location, and of government agencies that regulate certain lakes and rivers. Sporting goods stores may carry printed guides for local destinations.

Guidebooks should provide maps and detailed information on required permits, put-in and takeout points, campsites, boat liveries, location and classification of rapids, and recommended water levels based on local gauges. Sometimes a phone number will be given for learning the current gauge level. Restrictions on group size, the type of food containers, fire options, and human waste disposal should be noted in the guide.

While guidebooks can offer a wealth of useful information, don't forget that rivers change and that one person's Class II is another person's Class III. Check the guide's publication date and use other sources, such as phone numbers provided in the guide, to make sure the information is still accurate. The location that once was a freely used campsite may have changed hands, and the new owner may expect a fee or prosecute campers for trespassing. For lakes and rivers on public property, check with park or ranger personnel. For lakes and rivers bordered by private land, don't assume you can camp anywhere without prior permission. Campsites may be limited to canoe liveries and state parks that will charge a fee and may require reservations.



Who to Take Where

Recall that Safety Afloat guidelines do not permit Cub Scout or Webelos dens to conduct float trips.

Any youth operating a canoe or kayak must have passed the BSA swimmer classification test. Although there are special allowances for nonswimmers and beginners to ride as passengers under limited conditions, a unit with many members lacking swimming skills should concentrate on learn-to-swim opportunities rather than float trips.

Safety Afloat requires participants for trips on flat water and moving water below Class III to demonstrate basic skill proficiency. Ideally, skill instruction is provided before a float trip, but time may be set aside at the beginning of a trip for basic skill review. Travel distances the first day should be adjusted accordingly. If a group arrives at the put-in point at midday, then an overnight stay at the launch area allows for skill review in the afternoon, followed by an early start the next day. The unit leader needs to use sound judgment when considering such options. It may be reasonable to allow time at the beginning of a short trip to check out a new member who claims to have experience. In a pinch, such a person can ride in a boat with a skilled leader. It is not appropriate to attempt basic instruction at the start of a long, remote trip when every member of the crew is a novice.

On rivers with rapids above Class II, there are three options: (1) a group with basic skills may portage an occasional Class III rapid; (2) those with advanced whitewater training may run rapids rated at Class III or above, provided they are confident in their ability to do so after scouting each rapid; and (3) a novice group may ride in rafts (or dories) under the direction of a professional guide in each craft. That last option means that trip planning involves selecting a rafting company as discussed in Chapter 20.

All things considered, Safety Afloat guidelines require unit leaders to only consider float trips consistent with the skill levels of unit members, both youth and adults. That might limit a large troop to conducting special high-adventure trips only for older, more skilled members. A Venturing crew whose activity interest survey focuses on whitewater canoeing may set a goal of a trip down a local whitewater river. However, the crew may need to plan training sessions and intermediate trips to accomplish that goal.

How Far in How Long?

River guidebooks are likely to give mileages between takeout points but may not provide typical times needed to make a run. That's because "typical" depends on many factors, such as the water level; how often and how long the party stops to rest, eat, play, explore, or scout; and the physical conditioning of the party. A Venturing crew practicing for a marathon race might cover 20 miles in a day, but five to 10 miles is more "typical" for a day trip, depending on how much time is needed to get to the launch point and make any necessary shuttles to get home before dark.

The best way to judge the time needed to cover a given stretch of lake or river is to make a conservative estimate based on previous experience with a similar group under similar conditions. Given a choice of a takeout point that is a little short compared with the next one that is twice the distance, choose the shorter distance. That way, the group can take time to enjoy the trip rather than racing against dusk while fighting a strong headwind. Livery companies on popular rivers will be able to provide reasonable estimates of travel time for a given flow level.

For an overnight trip on a weekend, you may need to choose among several popular river segments even though the group would like to do more. Make sure to factor in driving time. If you rent boats from a livery company, the livery's location may dictate your put-in and takeout points. They may prefer you start or end at their location to reduce the number of shuttles. Alternately, you may be able to launch upstream one day, camp overnight at the company's campground, and continue the next day to a takeout point.

For an extended trip on the water, it is prudent to schedule a short leg or a layover midway through the trip, ideally at a spot where there is something else to do rather than paddle.

Gear: What, From Where, at What Price

At a minimum, any float trip will require boats, life jackets, and paddles. Overnight trips will also require standard camping gear and provisions. Detailed lists are needed later in the planning stage, but the source of boats is a major consideration when first deciding on a location.

A unit with its own boats and boat transport has the greatest flexibility in choosing a location. Some boat livery companies rent boats only for their local stretch of lake or river, but others will rent boats and trailers you can take to various locations within their region. Using a local livery company is advantageous when they transport the boats for you. Otherwise, arranging your own shuttle can take time away from the water. Many boat liveries supply only the necessary marine equipment. Others are total outfitters equipped to provide food, tents, and cooking stoves in addition to boats. Although contracting with a complete outfitter simplifies the planning, it also ups the cost. A typical unit may find a better fit to their budget if they rent canoes from their council camp, buy their own provisions, and use their own camping gear.

Note: Even though you have made reservations for boats for a certain time, rental companies, including local councils, may void the agreement at the last minute if a river is up due to heavy rains the day before. That's a prudent business decision on their part and it also speaks to your safety. The best-laid schemes "gang aft a-gley" and need contingencies.

How to Get There: People, Boats, and Shuttles

Buses are handy for large groups with gear traveling over long distances without boats, and commercial carriers are recommended. Many groups arrive that way at the Northern Tier bases. If a unit uses its own or a rental bus, the drivers must have the appropriate driving licenses. Smaller groups may travel in rented vans or private automobiles.

The best way to transport canoes or kayaks is on a trailer designed for that use. Make sure the boats are securely fastened with straps, bungee cords, or lines. Such trailers often have lockers for life jackets and paddles. If not, those are packed in the tow vehicle. Make sure that the tow vehicle and hitch are rated for the trailer and that



the trailer meets all legal requirements such as lights, license, and safety chains. You should carry a spare tire for the trailer and an appropriate jack.

It is also feasible to car-top canoes or kayaks for a small group. Pipe racks on pickups can often be used as is, but standard luggage racks on vans and SUVs are seldom designed for hauling boats, particularly two canoes side by side. You may be able to order special attachments from a dealer. Alternately, removable racks can be purchased. Some less-expensive models are generic and can be adjusted to fit many vehicles. Higher-end racks are tailored to fit specific automobiles. It is important to obtain a good-quality rack that is held securely to the vehicle. At highway speeds, the wind resistance on the boats creates large forces. Foam blocks and other temporary arrangements may be sufficient for transporting a new boat slowly from the store to a garage, but are not recommended for long distances at highway speeds.

The boats should be balanced on two racks that extend across the top of the automobile. If necessary, adjust the racks so that the end of the boat toward the front of the car is level or slightly down. The wind needs to part along the sides of the boat, not catch it from beneath. Canoes



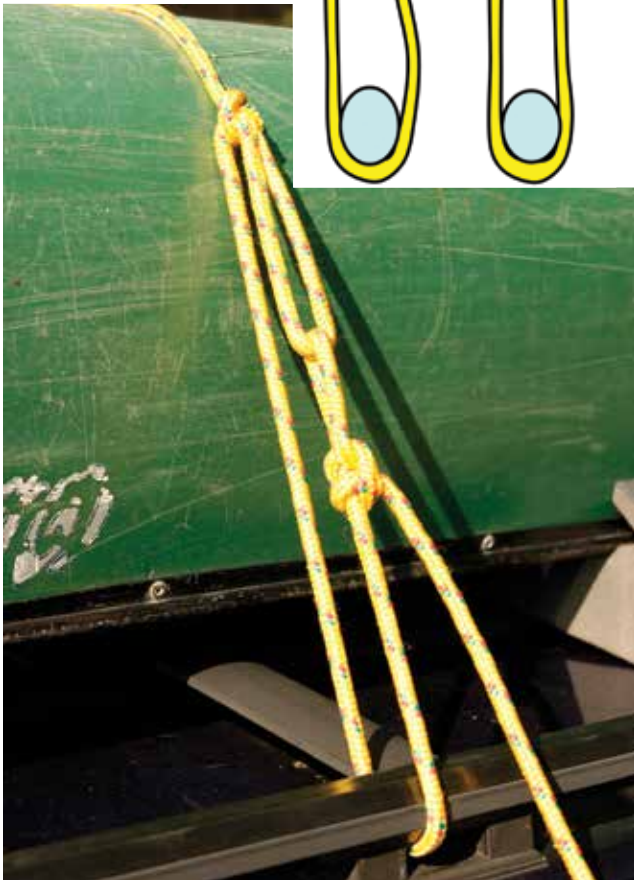
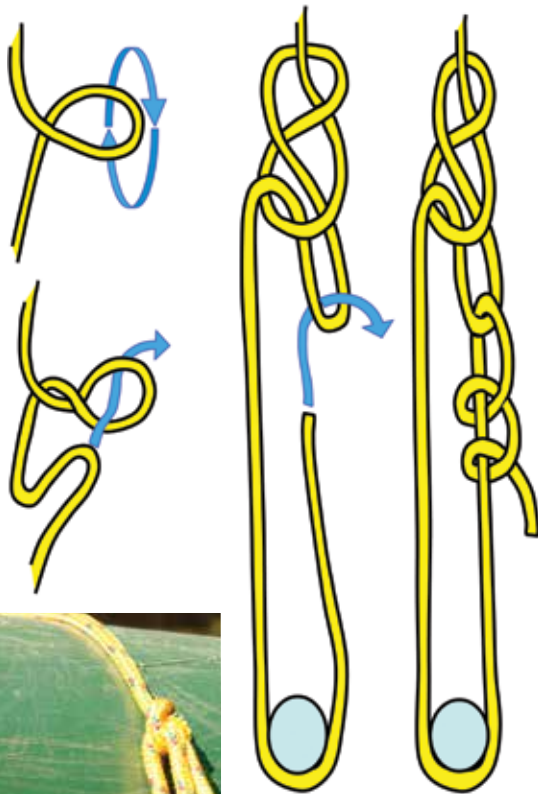

are loaded upside down; kayaks may be loaded either way, based on design. Some kayak racks have J attachments that rest kayaks on their sides. Secure the boat or boats to the racks using cam straps, bungee cords, or lines using a trucker's hitch. The lines should be tight and secure, but be careful: it is possible to tighten hard enough to damage the hull.

The lines across the racks keep the boats from sliding sideways and also help hold the boats down against aerodynamic lift. However, all but the shortest boats also need lines front and back for adequate security. Use rope or straps for these, not bungee cords. Ideally, the fore and aft lines should slant in opposite directions to hold the boats in place not only against the wind while moving forward, but also against sliding forward when braking.

Tie either the middle of a single line or two separate lines to a secure attachment near the forward end of the boat, normally where you would tie a painter to a canoe or to the grab loop on a kayak. Angle the lines down to the front of the vehicle to form a V. Old-fashioned metal bumpers offered several attachment options that are not available on newer plastic bumpers. Attach the ends of the lines to tow hooks or other secure spots on the frame beneath the bumper. Avoid sharp edges or moving parts. Alternately, you may be able to attach tie loops under the hood and still be able to shut the hood securely. Pull the lines snug, but not too tight, with trucker's hitches. Cut or secure loose ends to keep them from flapping against the car finish or getting caught in moving parts. Make another V in back.

On lakes, it is common to plan a circular trip that ends where it began. On rivers, it is common for the starting point to be upstream of the takeout. That difference requires a shuttle to get land transport from one location to the other. There are two easy ways to do it: (1) pay a reliable outside party to run the shuttle, e.g., a livery that includes a shuttle service as part of the package; or (2) have extra adults along willing to follow the party by road. Other options need careful planning and may involve several trips along the same road to reconnect gear, people, and vehicles. **Do not leave the shuttle to chance.** Hitchhiking is dangerous and unreliable, and transportation at the takeout is useful in case of an emergency.

A shuttle requires at least two vehicles. Dropping a vehicle at the takeout on the way to the put-in is a good option if the entire party and all the gear fit in the remaining vehicles. At the end of the trip, the majority of the party waits at the takeout while the drivers are taken to the start and then return. Make sure there are enough leaders to maintain adequate supervision and to satisfy Youth Protection policies for both groups whenever the party is split.

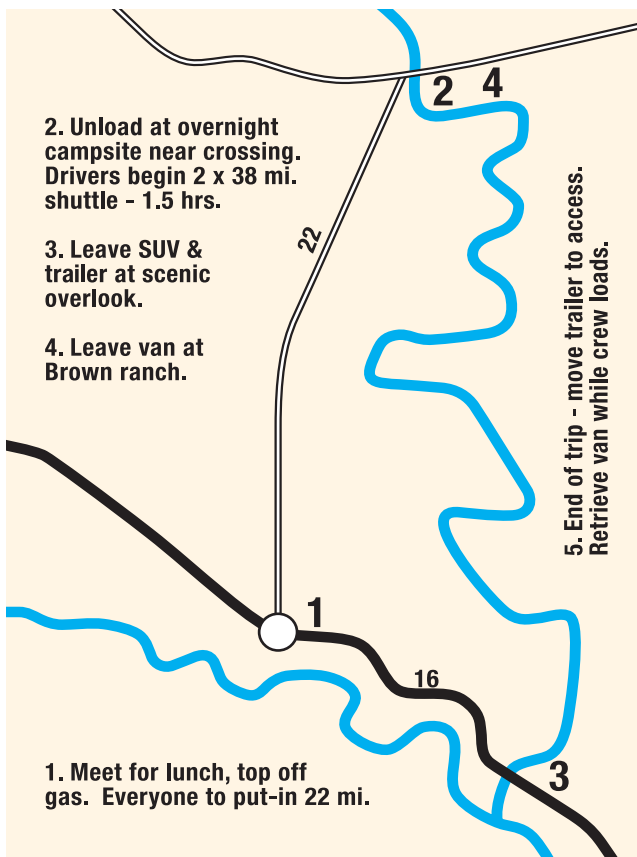

If all the vehicles are needed to transport people and gear, then the entire party goes to the put-in and unloads. Then two vehicles are driven to the takeout. One vehicle is left and both drivers return. When the party leaves the river, a double trip is required again.

For extended river trips, a round-trip shuttle may take several hours, particularly if there is no direct road between the put-in and takeout. If the party does not reach the put-in or takeout early in the day, an overnight camp may be necessary. In remote areas, make sure to maintain sufficiently full gas tanks to complete the legs.



On many rivers, common access sites are on public rights-of-way at bridge crossings, so shuttle vehicles are often left near bridges or low-water crossings. Although that practice is fairly common among river runners, it does risk the vehicle to theft and vandalism. A safer bet is to launch and land at established campgrounds. If a vehicle is left near a bridge, make sure it is above the high-water mark. Some folks are fearful of losing car keys on the river and will hide the keys near the vehicle, but you never know who is watching. It makes better sense to carry two sets of keys downriver in separate boats.

Float Plan

Once the waterway segment is decided on and other details considered, such as how to run the shuttle, it's time to plan a detailed itinerary. Folks who have run the river before are valuable resources. If you don't have such a person in your party, see if there is someone else around willing to offer advice based on personal knowledge.

Good maps make planning the itinerary easier. River maps in guidebooks or off the internet may be only sketches. Highway maps are typically at too large a scale to show useful back roads and don't reliably track all the bends in the river. County road maps are good for the back roads, and topographic

Crew Number 701A



Northern Tier High Adventure Programs
Boy Scouts of America
Trip Itinerary
(Please Print)

Advisor DANIEL WEST Base ELY
Assistant BRENT OWENS Return to Base 7-10
Interpreter BRYAN CRAFT Leave for Home 7-11

CREW MEMBERS

1. <u>DAVE SMITH</u>	6. <u>BILLY MACK</u>
2. <u>TOM MURPHY</u>	7. _____
3. <u>TERRY WOLF</u>	8. _____
4. <u>LEIGH WALKER</u>	9. _____
5. <u>BOB HALL</u>	10. _____

PROPOSED ROUTE

Date	Start at:	via:	Overnight:
7-2	<u>MOOSE LAKE-BOSE</u>	<u>PRAIRIE PORTAGE</u>	<u>BURKE LAKE</u> (1)
7-3	<u>BURKE LAKE</u>	<u>SHADE LAKE</u>	<u>SILENCE LAKE</u> (2)
7-4	<u>SILENCE LAKE</u>	<u>AGNES</u>	<u>ROSE ISLAND</u> (3)
7-5	<u>ROSE ISLAND</u>	<u>KAVIAUPI</u>	<u>MONTGOMERY L.</u> (4)
7-6	<u>MONTGOMERY L.</u>	<u>CAIRN</u>	<u>SARK LAKE</u> (5)
7-7	<u>SARK LAKE</u>	<u>KEEFER</u>	<u>KANSHAN LAKE</u> (6)
7-8	_____	<u>LAYOVER</u>	_____ (7)
7-9	<u>KANSHAN LAKE</u>	<u>NEST</u>	<u>WASH ISLAND</u> (8)
7-10	<u>WASH ISLAND</u>	<u>WIND LAKE</u>	<u>MOOSE LAKE-BOSE</u> (9)
_____	_____	_____	_____ (10)

LAYOVER TRIP TO DONNA LAKE



maps help spot campsites and emergency exit routes. In lake country, try to find a map that shows portage trails. For sea kayaking along the coasts, get charts for the water and maps for the land. Maps and charts in GPS navigation systems may or may not have the needed detail depending on the location and the data loaded.

The itinerary is part of the float plan, along with emergency contact information and contingencies. Refer to the sample form.

What to Take

What to take depends on the location, the duration, and the time of year. The following lists provide reasonable guidelines, but temper them with local knowledge and common sense. Camping from a boat is not that different from camping on a backpacking trip. For some trips you will need a heavy-duty sleeping bag; for others, a lightweight bag will suffice. In some areas, you may be concerned with bears; in other areas it may be alligators. Although gear capacity is limited in some kayaks, canoes and touring kayaks generally make it easier to carry more gear than on a backpacking trip. Even so, take enough to be comfortable, but don't pack gear you will never touch. Always follow Leave No Trace principles. Check the BSA *Fieldbook* for information on camping and the Leave No Trace program.

Paperwork: Group and Individual

- Copies of the float plan
- Route maps
- Permits
- Identification (passports for foreign travel)
- Medical histories with treatment consent
- Fishing licenses
- Cash and credit cards

Boats

- Life jacket sized for each occupant
- Paddle sized for each occupant
- Sponge, bailer, or pump
- Throw bag
- Painter
- Portage yoke if much carrying is anticipated
- For white water, add float bags and a helmet
- For cold water, add gloves and a wet suit

Group Equipment and Provisions

- Extra paddles
- First aid kits
- Emergency communication devices (cell phones, radios) with extra batteries
- Weather radio (hand-cranked versions available)
- GPS system
- Emergency beacon
- Repair kit (duct tape at least)
- Packs or gear bags with waterproof liners
- Miscellaneous straps and cord
- Tents, with ground cloths
- Dining fly
- Drinking water/water purification system
- Food
- Ice chest for short-term storage of perishable items
- Cook kit
- Butane lighters or waterproof matches
- Stoves and fuel*
- Cleanup kit (biodegradable soap, sanitizing rinse agent, trash bags)*
- Toilet paper with pack-out kits as appropriate*
- Small trowel*

*Leave No Trace

Personal Gear

- Medications
- Whistle (attached to life jacket while on the water)
- Pocketknife
- Compass
- Water bottle
- Sun protection (hat and sunscreen)
- Sunglasses (prescription, if needed) with strap
- Insect protection (repellent; head net in some cases)
- Rain gear (hooded jacket and pants—no ponchos!)
- Stout, no-slip footwear that can get wet and will dry quickly
- Shoes for camp wear
- Swimsuit or quick-dry shorts
- Change of clothes appropriate for season
- Light jacket or layers in cold weather
- Toiletries
- Eating utensils (bowl, cup, spoon)
- Sleeping bag
- Sleeping pad
- Flashlight
- Camera

How to Pack

The challenge when packing for a float trip is to keep things dry. Water easily finds its way into any opening. For a short day trip, a 5-gallon plastic paint bucket with a sealing lid, available empty at discount outlets, makes a reasonable container. It has enough space for lunch and essentials, and is light, waterproof, and inexpensive. If you like, take off the handle and thread a light line through the hinge for tying to a thwart. If the canoe capsizes, the bucket can be cast free—it will float with a reasonable load.

A bucket, or any other secure container, is difficult to open and close quickly while under way. Waterproof items you need often, such as sunscreen, are better kept in a simple fanny pack that can be tied to a thwart. An underwater camera housing is useful if you want to take snapshots without jeopardizing an expensive mechanism. Some digital cameras have enough water resistance to shake off an occasional splash with no ill effect.

For overnight excursions you can use conventional packs, either with or without a frame. Cook pots need no additional protection, but food, clothes, and sleeping bags do. Individually bag items in zip-lock or heavy-duty plastic garage bags, and then place those within a larger bag. Leave enough room to make a twisted, fold-over gooseneck that can be secured with rubber bands. Make sure to carry plenty of folded spare bags and rubber bands since rips are common. Pack food in clear bags so contents are visible after the outer bag is opened.

You can also purchase special gear bags with various waterproof, or near-waterproof, closing mechanisms, but double layering is still useful for critical items. Special containers fit the spaces beneath kayak hatches easier than generic backpacks will fit.

Once the gear is secured in waterproof containers, place the items in the boat. In a canoe, place the gear on the bottom in the center. Balance the load so that the canoe, paddlers included, stays in trim both sideways and fore and aft. Tie the gear in, particularly any item that doesn't float well, so it is not lost during a capsize. Gear secured well will displace water in a swamped canoe and help float the boat higher. On the other hand, a complicated tie-in system can make it more difficult to empty a swamped canoe.



A cruising canoe can hold an amazing amount of gear, as shown in the photo on a previous page. Like to cook in a Dutch oven? There's plenty of room to carry one. However, if your trip involves reaching your destination by float plane, portaging from lake to lake, or moving gear on steep, rough trails around rapids, keep the number and weight of the items small enough that everything can be carried in one trip.

On a backpacking trip, hikers typically carry individual packs. On a canoe trip, it often makes sense to share a pack. That allows one person to portage gear while the other carries the canoe. Split critical group supplies, such as food, between boats. If a boat is lost, including its share of the gear, the group should still be able to continue, although on a shorter schedule, perhaps.

On the Water

Planning needs to include procedures used on the water. Buddies in tandem boats should be matched according to size and skill as well as compatibility. Size is a consideration for proper trim. Pairing those with lesser skill with more experienced paddlers will keep the group moving efficiently while providing valuable training. Buddy boat assignments for solo craft should also pair experienced paddlers with novices. However, make sure the lead and sweep boats have experienced crews. It is particularly important to have someone familiar with the route in the lead boat. A missed portage trail or scouting location could lead the following boats into hazards.

If possible, plan a route that follows the shoreline rather than striking long distances across open water. If a long-distance, open-water segment is desired, for example to reach an island campground, review local and approaching weather patterns before leaving shore. Either wait or take a contingency route if facing strong winds, high waves, or strong currents. Be leery of leaving a shoreline with the wind at your back. While such a wind will help push you in the desired direction, it may also cause increased offshore wave action that makes the path ahead hazardous and the return path to safety increasingly difficult.

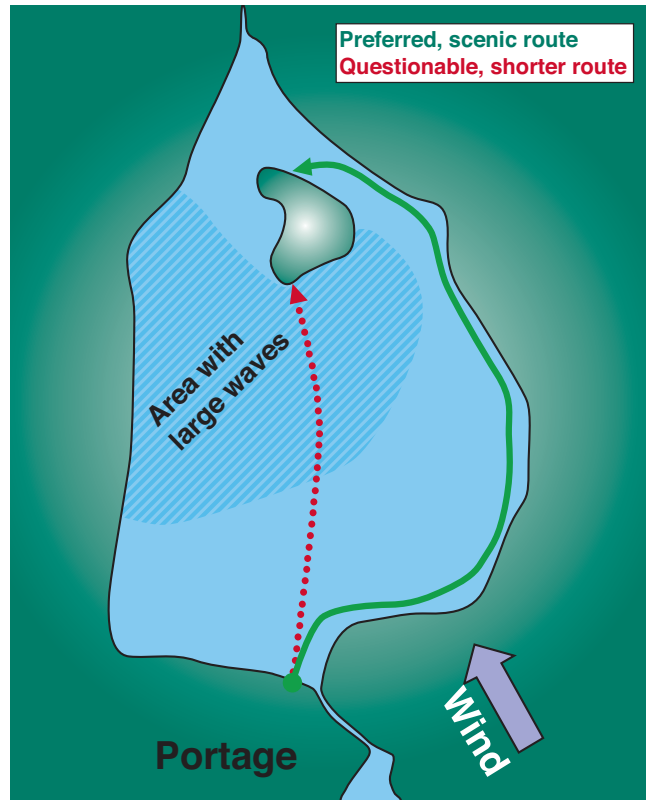

When planning a long trip with several portages, try to arrange the route so that longer portages come after the group becomes conditioned on shorter runs. Plus, the weight of food decreases as the trip progresses. Make sure to allow extra time in the itinerary for long or difficult portages.

When stopping at a campsite, make sure to secure all boats against changes in wind or water levels during the night. Normally, that means bringing them completely ashore. Minimalist campers may use the canoe itself as a shelter. An overturned canoe balanced on rocks serves as a makeshift table for food preparation.



Sample Float Plan (Different formats may be used, but should include all relevant information.)

MEMBERS

AGE

Check if currently trained in:

Trip leader:

Safe Swim
Defense

Safety Afloat

CPR

First Aid

1. _____

[]

[]

[]

[]

Assistant leaders:

2. _____

[]

[]

[]

[]

3. _____

[]

[]

[]

[]

4. _____

[]

[]

[]

[]

Youth members:

5. _____

6. _____

7. _____

8. _____

9. _____

10. _____

11. _____

12. _____

13. _____

14. _____

ITINERARY

Date:

Start at:

Via:

Overnight:

_____	_____	_____	_____
_____	_____	_____	_____
_____	_____	_____	_____
_____	_____	_____	_____
_____	_____	_____	_____
_____	_____	_____	_____

CONTACT INFO—Names and numbers or radio info for:

Party _____

Emergency services _____

Emergency contacts _____

TRANSPORTATION

Automobiles:

Boats:

Number _____

Number _____

Type _____

Type _____

License _____

Registration _____

Parked at _____

Rented from _____

NOTES

Carry float plan with health histories, consent forms, and required permits. Leave copies with contacts.



Rowing

Traditionally, oars were the primary motive power for small craft for a wide range of commercial and recreational activities such as fishing, ferrying, bird hunting, and tending larger vessels. The advent of small outboard motors has almost made rowing a lost art today. Basic rowing skills are still advantageous, however, in several situations. Many youth are attracted to rowing as a fun activity because they are interested in boats of all kinds.



Sliding-Seat (Competitive) Rowing. Competitive rowing is gaining popularity as more schools and clubs sponsor teams. A local rowing club could provide resources for a Venturing crew to specialize in the activity. Sliding-seat rowing provides excellent whole-body aerobic exercise, and there is joy in how easily a long, slender craft glides through the water. However, most such craft are not well suited for anything beyond rowing in a straight line on calm water. Only a few sliding-seat designs are available for transporting people and gear on trips. They are not useful as tenders or for fishing and such.

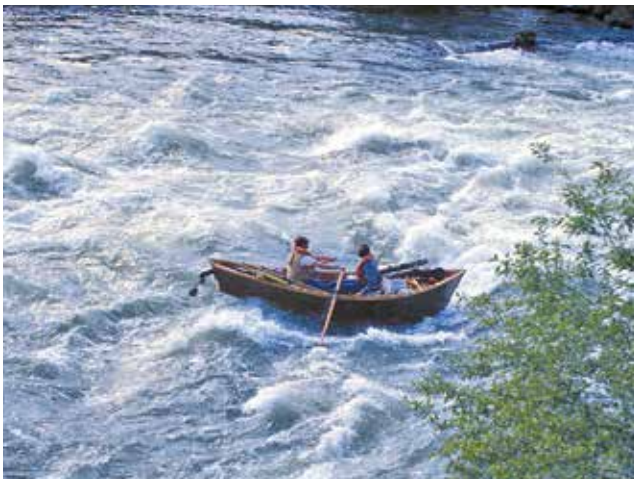

River Dories. Dories are used on several western rivers for running whitewater and drift fishing. Running rapids in any craft requires specialized skills. Youth groups should normally ride as passengers in such craft with the rowing done by an experienced guide.



River Rafting. River rafting was mentioned briefly in Chapter 20 as a means by which youth groups without specialized skills can experience white water. Oared rafts are also used as support craft for kayaking groups.



Conventional Rowing. Rowing is a useful skill when using small boats as tenders to cruising sailboats, as guard craft during unit swims, or to move quietly from one fishing spot to another. Rowboats are suited for such purposes due to their carrying capacity and stability, particularly in waves. In some countries, properly designed and equipped rowboats are offered for hire in public parks.

Boat Design

Although many excellent rowboat designs are still manufactured, those tend to be of limited production and expensive. Most small craft outfitted with oars are actually designed for small outboard motors. The back seat will be positioned forward of the transom to allow space for a fuel can and to allow better trim and tiller control. Oarlock sockets may not be positioned correctly for easy rowing. Compared to a dory or other classic design, the typical small powerboat under oars may seem sluggish but will generally perform well if the oars are correctly sized.



Oars

Probably the greatest impediment to easy rowing is the tendency to use oars that are too short. Oars must be sized to the boat, not the rower. That is, a Cub Scout will find it harder to row a wide-beamed boat with short oars than with long oars. Typically, oars need to be 7 to 8 feet or longer, but unfortunately the sporting-goods departments of large chain stores will often only stock 6-foot oars. Therefore, you may need to special-order the correct size oars for your boat. Be aware that price increases with length.

Correctly sized oars resting in the oarlocks should float with the blades in the water and the handles meeting amidships at belly-button height of a person centered on the seat. The correct oar length will increase with beam width and freeboard height. If the oars are too short, they will dig too deep in the water, pop out of the lock, and force the rower to position the hands either too high or too far apart for efficient rowing.

Buttons on oars are not essential but do help keep the oars positioned, while the rower is reaching for a flotation device to throw to a swimmer in distress, for example. Oars with buttons typically also have sleeves or leathers to protect the oar from wear on the oarlock. Traditionally, buttons and sleeves were made from leather held in place by stitching or tacks, but rubber and plastic versions are available. The button should clear the lock when the oar is in use.

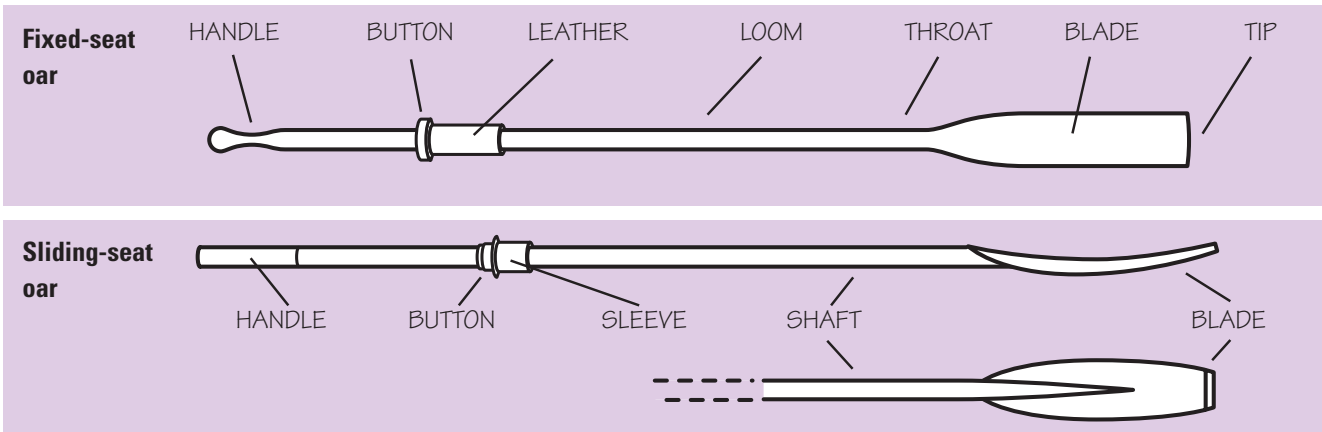
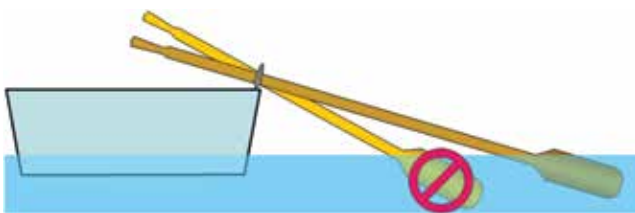

Oarlocks

The next key to effective rowing is a proper oarlock. Folks attempting to row with oars that are too short tend to favor locks, such as clamps and pins, that hold the oar to the boat. An oar that is too short will tend to pop out of an open-top oarlock. Open-top or ring locks are preferred since they allow the oar to feather. Again, these may be special-order or internet shopping items. The typical sporting-goods department may stock only the inferior styles, if any.

The socket for the lock should be located approximately forearm or thigh length aft of a rower sitting upright on the seat. The lock should be secured to the socket with a chain or lanyard so that the lock can be lowered when people are getting in and out of the boat. Alternately, a ring lock may be left on the oar beneath the button, or a self-contained Davis lock may be used.

Note that other styles of locks are used with sliding-seat and raft rigs.



Davis (rowing position)

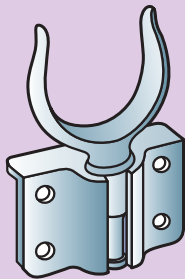

Davis (safety position)

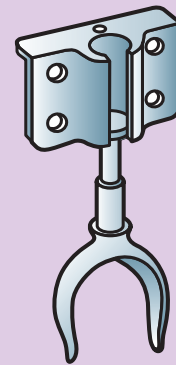

Open

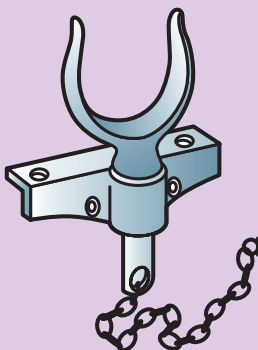

Ring

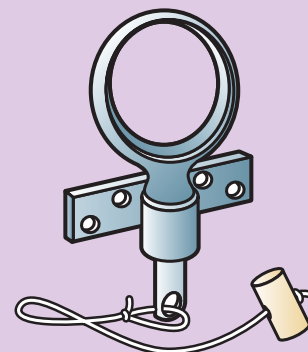

Moving Forward

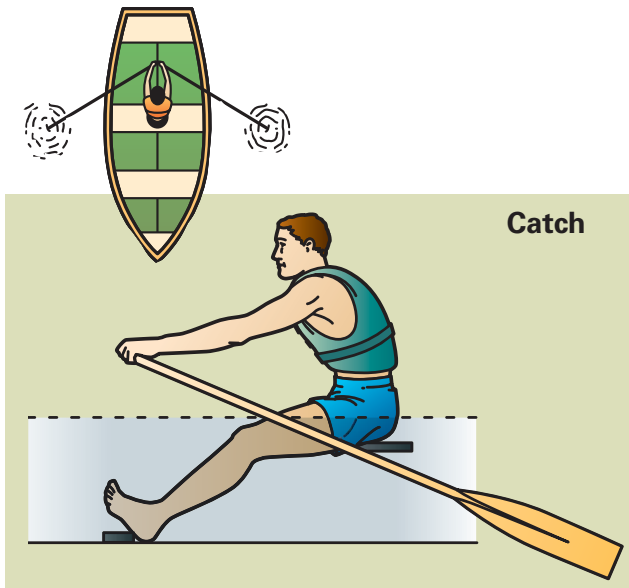

Catch. Facing aft with blades clear of the water, lean toward the stern with arms stretched forward. Drop the blades into the water edgewise.

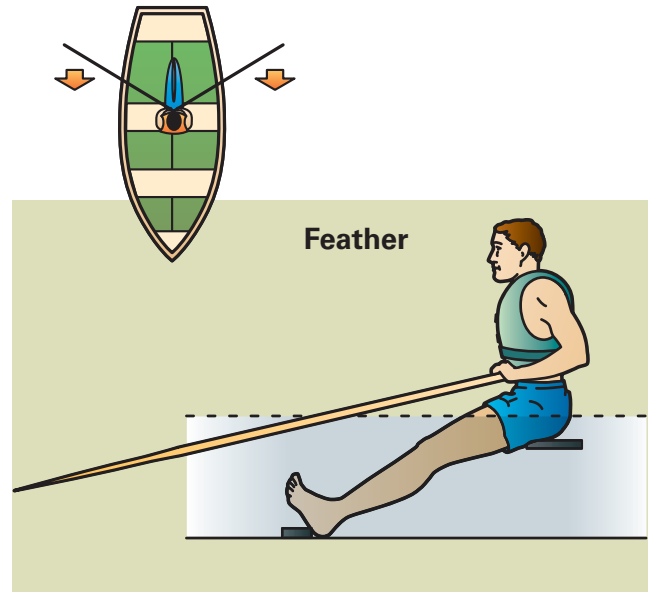

Feather. Rotate the blades almost flat to the water by rolling the wrists down. Feathering prevents wind and wave resistance during the recovery.

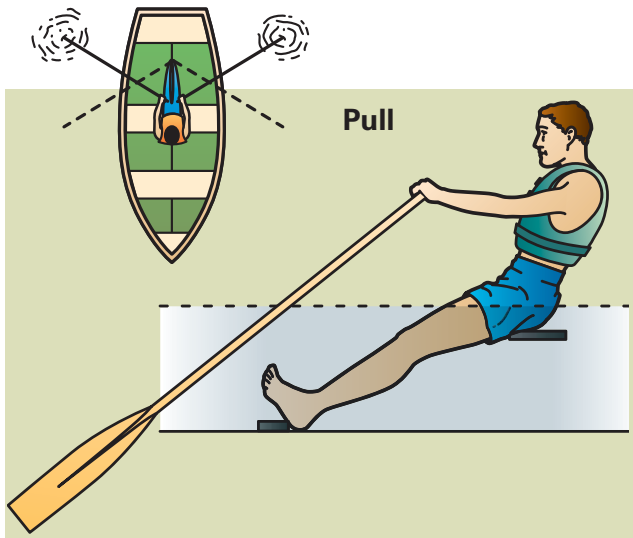

Pull. Brace your legs and sweep the blades aft by first leaning back with arms straight, and then finish with elbows next to your sides.

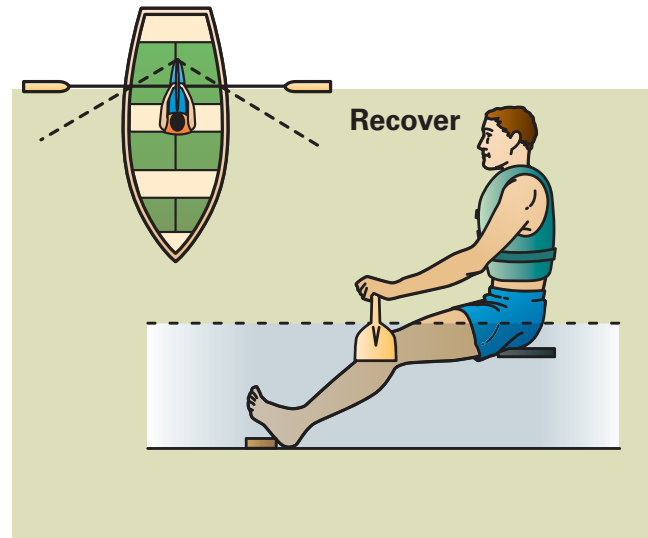

Recover. Return to the catch position by leaning forward with the blades feathered just above the water (or skipping across the surface if there aren't any waves).

Moving Backward



Catch. Angle the oars slightly aft by pulling your hands to your belly with your elbows at your sides. Drop the blades into the water edgewise.



Feather. Rotate the blades almost flat to the water by rolling the wrists up. (Your hands twist in the opposite direction to the forward stroke.)



Push. Lean aft and straighten your arms to sweep the blades toward the bow. Finish with arms extended aft.



Recover. Pull back on the oars to return to the catch position with the blades feathered just above the water (or skipping across the surface if there aren't any waves).

Stops, Turns, and Pivots

To stop, hold water with the blades submerged, or reverse the stroke slightly.

To turn under way, pull harder on one oar than the other.

To pivot, or spin in place, row forward with one oar while backing water with the other.



Pivot-catch



Pivot-push-pull



Pivot-feathering

Rowing Tips

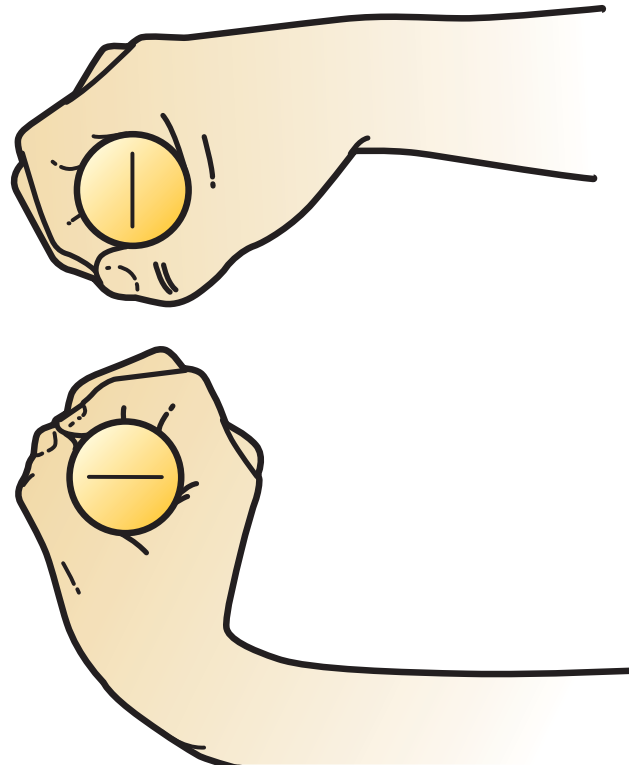

Common errors can be avoided by imagining that you slide your hands within a narrow, flat track or “groove.” Keep the grips close together with your elbows down. Having your hands too far apart reduces your leverage against the oarlock. Minimize vertical movement to prevent “windmilling.” If you push your hands down while feathering, you waste energy lifting the blades too far out of the water. If you raise your hands during the catch and pull, the blades go too deep into the water and you are likely to pop the oar out of the lock. Be careful during the recovery to keep the leading edge of a feathered blade tilted slightly up. Otherwise, the blade will dive into the water if you try to skim the oars or catch a bit of wave chop. The reaction of a diving blade, called “**catching a crab,**” may be strong enough to knock you from your seat.

Additional tips on oar length, boat trim, maintaining course, sculling, sliding-seat rowing, and other subjects can be found in the *Rowing* merit badge pamphlet.

Swimmer Assists

Rowboats used as guard craft at a unit swim should be positioned at the perimeter of the swimmer area and crewed by a buddy team equipped with rescue aids. Distressed swimmers can be thrown a flotation aid as the rower backs water to allow the person to grasp the transom. A reach pole or an extra oar may be used as a reaching device. Incapacitated swimmers are held at the back of the boat by the coxswain as the rower moves the

boat quickly to shore. If the boat is a long distance from safety—for example, guarding a snorkeling party near a reef—the victim can be lifted over the stern of some boats if rescue breathing/CPR is needed.

If rowboats are used to protect long-distance swimmers in open water, such as for the Mile Swim, then BSA policies state that the swimmer is followed by a rowboat with both a rower and a spotter.

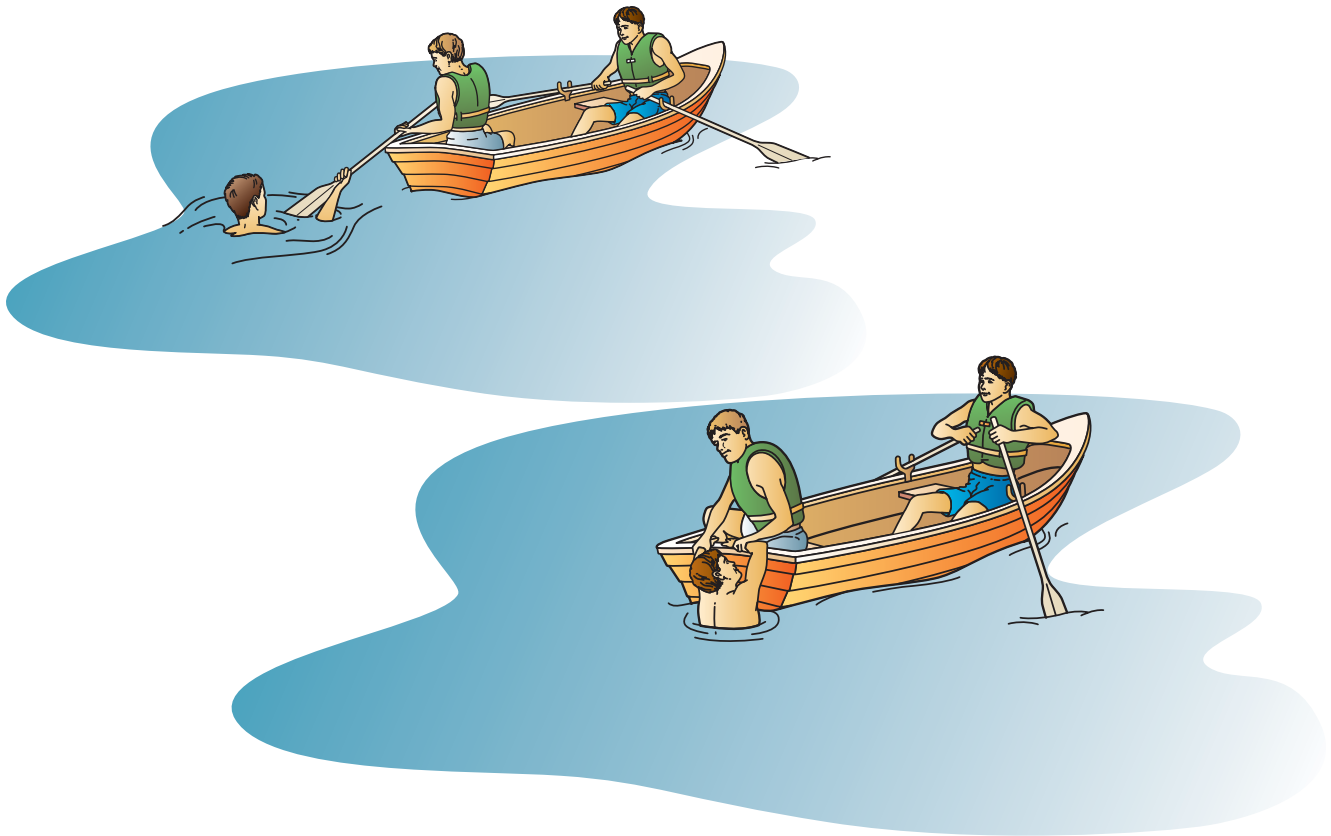



Sailing

Sailing is a popular recreational activity that is fun, healthy, challenging, and not as expensive as one might assume. Many of today's youth are keenly interested in sailing but may have little access to boats and little opportunity to learn sailing skills. Scouting programs address that gap and provide sailing opportunities in more than one format in boats of various sizes. Some focus on the individual, others on the unit. This chapter addresses program opportunities rather than specific sailing skills. Basic sailing skills are introduced in the *Fieldbook* and covered more thoroughly in the *Small-Boat Sailing* merit badge pamphlet.

Small-Boat Programs



The Small-Boat Sailing merit badge is designed primarily for the individual Scout and their buddy using small craft with limited crew capability. Scouts can earn the merit badge from local counselors and at many council summer camps.

Some Venturing crews, particularly Sea Scout ships, specialize in sailing as one of their primary activities. The following elements should be considered for such programs:

- Sailing for pleasure with competition only as an option
- Learning by doing
- Using youth members as counselors aided by volunteer consultants

- Maximum time on the water with a minimum of lectures
- Visual aids and simple instructional materials to support learning
- A series of sailing exercises and drills to add fun to skills practice
- Competition with those of like ability with an emphasis on fun rather than winning

Professionally Crewed Day Trips

Several large sailing vessels offer scheduled day trips for the general public from various ports on the coasts and the Great Lakes. These offer a fun introduction to large-boat sailing to BSA members of all ages and abilities and can accommodate large groups if prearrangements are made for a block of tickets. However, the group will be passengers with limited opportunities for learning skills. Make sure the captain and the vessel have current U.S. Coast Guard credentials.



Captained Charters

An active industry of large and small companies provides crewed boats for hire for typical terms of one to two weeks. The crew may consist of only a captain or include a mate/cook. Patrons can leave everything to the crew or operate the vessel under supervision. Fees and availability may vary by season. Summer is the prime season in northern waters around Maine and Vancouver. In southern waters, particularly the Caribbean, summer is the off season due to heat and potential hurricanes. Typically, group size is limited, around four to eight, but some larger vessels are available. Catamarans may accommodate larger numbers than a monohull of the same length.

While there are many well-maintained boats with reputable captains willing to work with Scouting groups, there is also the potential for a bad experience, particularly when booking sight unseen months in advance. An easy way for a unit leader to vet a boat and crew is to book the trip through the BSA's Florida National High Adventure Sea Base or through several council high-adventure bases that offer similar opportunities. A few vessels are available for groups of 20 or so.

Bareboat Charters

Boats may also be hired without a crew. That frees space aboard for other unit members but also places greater responsibility on the unit leader. Before renting boats, charter companies generally require proof of sailing competency. If you don't qualify, some will provide a captain for an additional fee. You will need experience on larger boats to qualify. One way to gain that experience is through a keelboat training program. There are numerous sailing schools affiliated with organizations such as US Sailing or the American Sailing Association whose training programs are recognized, or required, by charter companies. Information on sailing schools and charter companies may be found in *SAIL* magazine and on the internet.

Many charter companies restrict sailing to daylight hours within sight of land. Those are good guidelines for any amateur skipper and crew.



Cruising Checklist

Not all charter companies require the same experience, and a unit may also have the opportunity to use a private vessel on a local lake skippered by a member's parent. For a self-assessment, the following checklist of gear and skills may be used. Details will vary depending on the type of vessel and the cruising area, but a lack of comfort in any pertinent area is a flag that needs additional review. A similar list should be reviewed with a charter company before accepting a vessel.

Rigging:

- Standing rigging (stays, shrouds, spreaders, life-lines, etc.) in good condition and properly adjusted.
- Running rigging in good condition and understood. Operation of every line, cleat, and winch is clear and it is obvious how to:
 - Raise, lower, and reef the main, including any roller reefing or topping lift
 - Raise, lower, or roller furl the jib, including whether the furling system can be used to reduce sail
- Ground tackle should include at least two anchors and rodes.

Mechanical Systems:

- Rudder operation checked. Wheel has centerline indicator.
- Swing keel operation reviewed.
- Operation and basic maintenance of the auxiliary engine is clear (start, throttle, neutral, engaged).
- Engine compartment clean (to allow easy determination of new fuel, oil, or water leaks).
- Cooking system operation and safety precautions reviewed.
- Fire extinguishers easily accessible for either engine or cooking fires.
- Bilge pump operational; manual backup system available.
- Freshwater system reviewed (capacity, pump operation, level indicator, cutoff valves, filling procedure).
- Fuel system reviewed (fuel type, capacity, level indicator, cutoff valves, filling procedure).
- Head and shower operation reviewed, including holding-tank capacity and emptying.



- Dinghy checked (towing or storage system, outboard operation and maintenance, repair kit for inflatable).

Electrical/Electronic Systems:

- Is generator attached to auxiliary engine or separate?
- Battery system reviewed (charging procedure, bank usage, and switching).
- Shore power connections reviewed.
- Navigation and interior lighting system reviewed.
- Marine radio operation and procedures checked.
- Is there a system for weather forecasts?
- Depth-finder operation and alarm setting. Lead-line backup.

Mal de mer



The constant motion aboard a boat can unsettle the stomach and produce nausea or worse. Those who have problems with motion sickness in cars should seek medical advice before a sailboat cruise. Prescription medications are available. Over-the-counter pills may work for some sufferers. Just about anyone will show signs of seasickness if below deck in a hot, confined space when the boat is pushing through swells while heeling. Anyone green behind the gills should stay on deck in the fresh air with a view of the horizon. A turn at the wheel or another task may help. Hopefully, the feeling will soon pass. However, anyone stricken with severe motion sickness should be monitored for dehydration.

Navigation Aids:

- Chart plotters up-to-date with clearly understood operation?
- Backup paper charts and magnetic compasses available?
- Binoculars supplied?
- Is there a local cruising guide with information on channels, anchorages, etc.?

Accommodations and Provisioning:

- Adequate sleeping space for all aboard, consistent with Youth Protection policies?
- List of personal gear provided to each unit member?
- Is food provided by the charter company, by the unit, or a combination?
- Are any perishable food items properly stored (icebox or refrigeration)?

Maneuvers

Is the skipper confident that supervised crew members can:

- Set and trim sails for all points of sail (tack, reach, and run).
- Come about.
- Plot a course to the next waypoint.
- Read channel markers.
- Follow rules-of-the-road when encountering other vessels.
- Quickly recover a person who falls overboard while under way.
- Quickly de-power, lower, and/or furl sails.
- Anchor, moor, or dock under power in potentially crowded anchorages.
- Anchor, moor, or dock under sail if auxiliary power fails.
- Manage adequately if skipper becomes incapacitated.

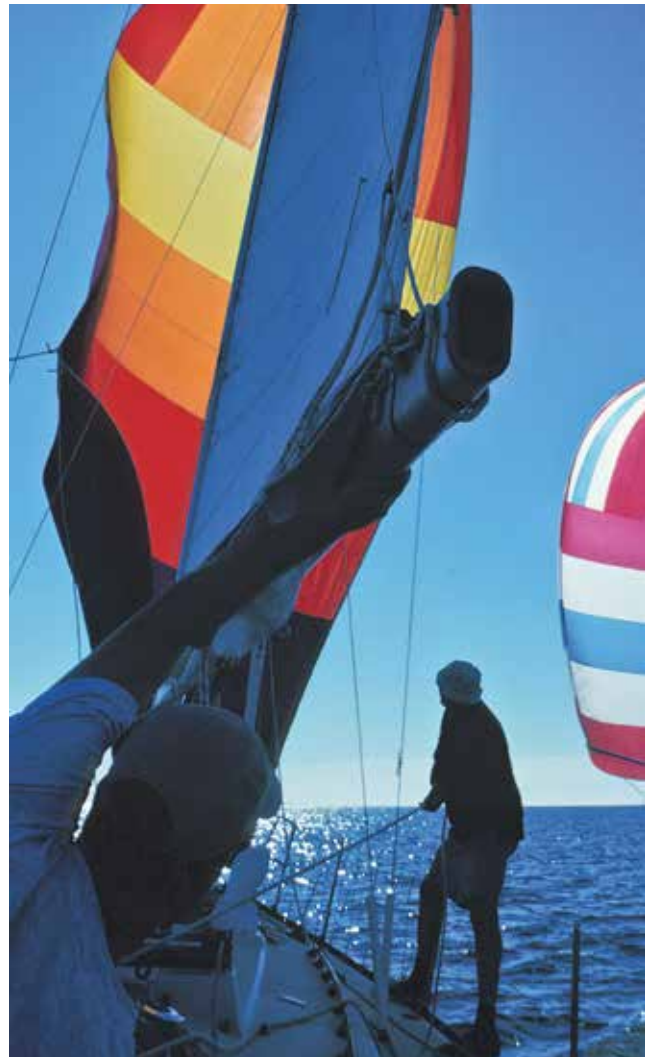

Float Plan:

The charter company should provide advice on:

- Local sights and activities, such as a good snorkeling location.
- Local regulations (e.g., fishing licenses) and customs.
- Good and bad anchorages.
- Tricky channels.
- Good restaurants for a treat and places to avoid crowds.
- Provisioning locations.
- Who to contact, where, and how, for minor and major emergencies.

Emergencies:

Discuss with the charter company:

- Major medical emergencies.
- Minor medical concerns (should have a first-aid kit adequate for removing fishhooks, etc.).
- Major vessel damage.
- Theft or other criminal activities.
- Running aground.
- Location and use of flares and other emergency gear.

Although basic sailing procedures are universal, different boats have different systems and will handle differently. The above checklist is for guidance only and does not substitute for experience. Nothing beats a short shakedown on the actual vessel or a sister ship. Someone confident in tight maneuvering of a 25-footer may still be intimidated the first time at the wheel of a 45-footer. Don't hesitate to inform the charter company of such concerns. They may offer to have, or insist on having, a representative aboard for a short time while you get the feel of the boat.

NOTE: Because most cruising sailboats have auxiliary power, skippers must also comply with all rules applicable to motorboats. Chapter 25 on motorboating provides additional guidance.



Boardsailing

In 1969, Americans Jim Drake and Hoyle Schweitzer combined sailing and surfing and founded a new aquatics sport. **Windsurfing** is the popular expression used to describe the use of a **sailboard**, but that term was initially trademarked. **Boardsailing** was the generic alternative used when the activity became a full Olympic sport in 1988. Boardsailing is fun, relatively inexpensive compared with some sports, and great exercise.



Sailboards can reach speeds of 40 mph, ride huge waves, and even go airborne. When learning, it is very important to select the right equipment to learn the basics. An experienced instructor will make the effort much easier. US Sailing (www.ussailing.org) and US Windsurfing (www.uswindsurfing.org) provide information on courses and online tutorials. Some Scout summer camps offer boardsailing programs, and your local council may have a list of Boardsailing BSA counselors. A Boardsailing BSA award application is provided in Appendix 3.

The Board

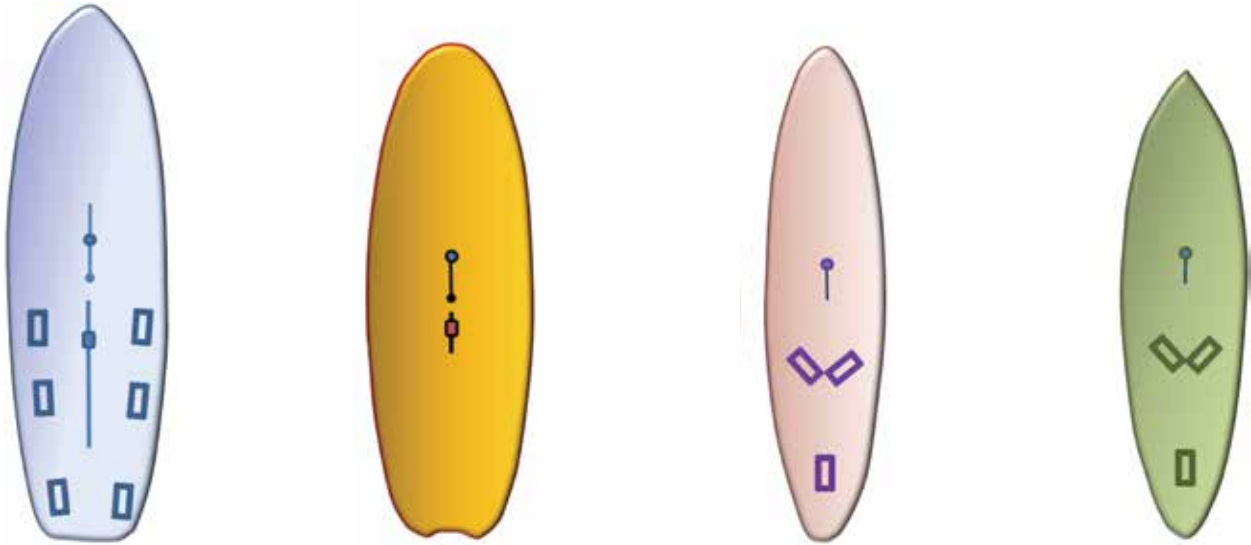

Learning is easier with a board that has good stability and buoyancy. Therefore, start with a wide board with a large volume. Avoid short advanced shapes with a narrow nose and tail until you have mastered the basics.

Less expensive boards made of molded polyethylene are tough but are heavier than more expensive boards made of various composites such as fiberglass, Kevlar, and carbon fiber.

The **nose** or bow at the front of the board is shaped to ride over small waves without diving.

The **tail** or stern always remains in the water. A wide tail provides increased stability that allows you to move back on the board.

A small fin or **skeg** is attached on the underside of the tail to help tracking. Without it, the board would spin in circles.

A **mast track** or foot on the top of the board near the center holds the sailing rig to the board.

Just aft of the mast track, most boards have a second, larger fin that helps the board point closer to the wind, the same as a **daggerboard** or **centerboard** on other sailing craft. There may be a lever handle on top of the board that pivots the blade up and down.

The tops of all boards should have a **nonslip coating** to allow you to stand on the board without slipping.

Many boards will have **foot straps** positioned aft on each side of the board. Foot straps are not needed for basic maneuvers and should not be used by beginners.

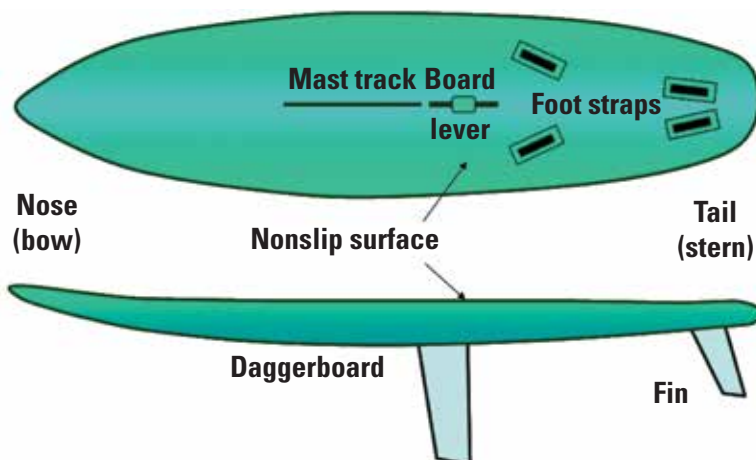

The Rig

The **rig** consists of the sail and the spars that hold it in place.

The front edge of the sail is the **luff**, the back edge is the **leach**, and the bottom is the **foot**.

The **mast** is a rigid tube of metal or composite material that slides into a sleeve along the luff of the sail.

The **mast foot** at the bottom of the mast has a **universal joint** that attaches to the board's mast track. The attachment allows the rig to pivot in any direction.

A **safety leash** provides a backup connection to the board in case the mast foot fails. A rig attached to the board makes it less likely to blow away from a sailor dumped in the water.

The back of the sail is held away from the mast with a divided wishbone **boom** usually made of aluminum. The boom attaches to the mast with an adjustable **clamp** in a cutout in the luff sleeve. The boom is used to control the sail and has a textured grip on both sides of the sail. For best results, the boom should be positioned on the mast between shoulder and chin height.

The back corner of the sail, or **clew**, attaches to the back of the boom with a line called the **outhaul**. The bottom of the sail at the luff is the **tack** and is attached to the mast with another line called the **downhaul**.

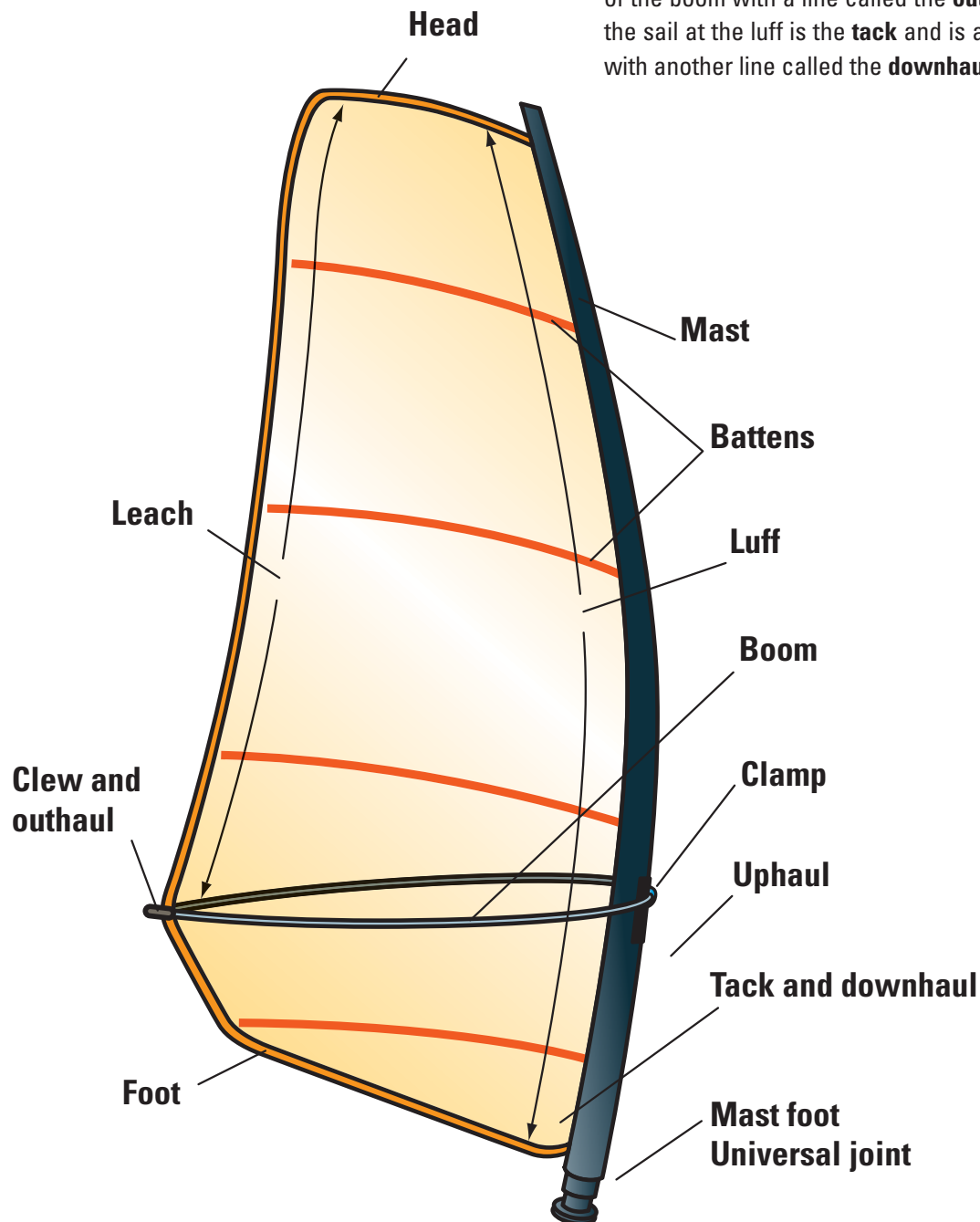



The sail functions best when the downhaul and outhaul are properly tensioned to produce a smooth airfoil. Flexible **battens** running across the width of the sail help maintain the shape. Pulleys are used to gain sufficient tension in the downhaul to flatten the sail along the luff. The clew is tensioned sufficiently to keep the sail off the boom. Once pulled taut, the lines are held in place with various types of **cleats**.

The **uphaul** is a line attached to the boom that is used to pull the rig from the water into a sailing position.

If you buy a rig, it should come with rigging instructions, but the novice using a camp or rental board should rely on an instructor to provide guidance. For best results, the fullness of the sail can be adjusted, or **tuned**, based on wind conditions.

Sail designs vary with use. Racing sails are large, with a tall luff, a long boom, and a low foot. Wave sails used in the surf have a shorter luff and boom and a higher foot. Generally, beginners should start out with smaller sails. A sail that is too big for the wind conditions is difficult to control and tiring to use.

Moving to the Water

Initially you can rely on your instructor, but eventually you will need to learn how to rig the sail and move it and the board to the water, and attach the rig to the board. The illustrations provide pointers.

Before you start to sail, for the first time or the umpteenth, make sure your gear is ready: Double-check your life jacket and the rig, particularly the mast foot attachment.

Also check the weather and surroundings. Beginners should start in light winds (3 to 7 knots) and calm, uncrowded water. Do not launch into winds that are blowing offshore into large expanses of water.



Carry the board at your side, with one hand on the centerboard and the other on the mast track. Avoid turning broadside to the wind.

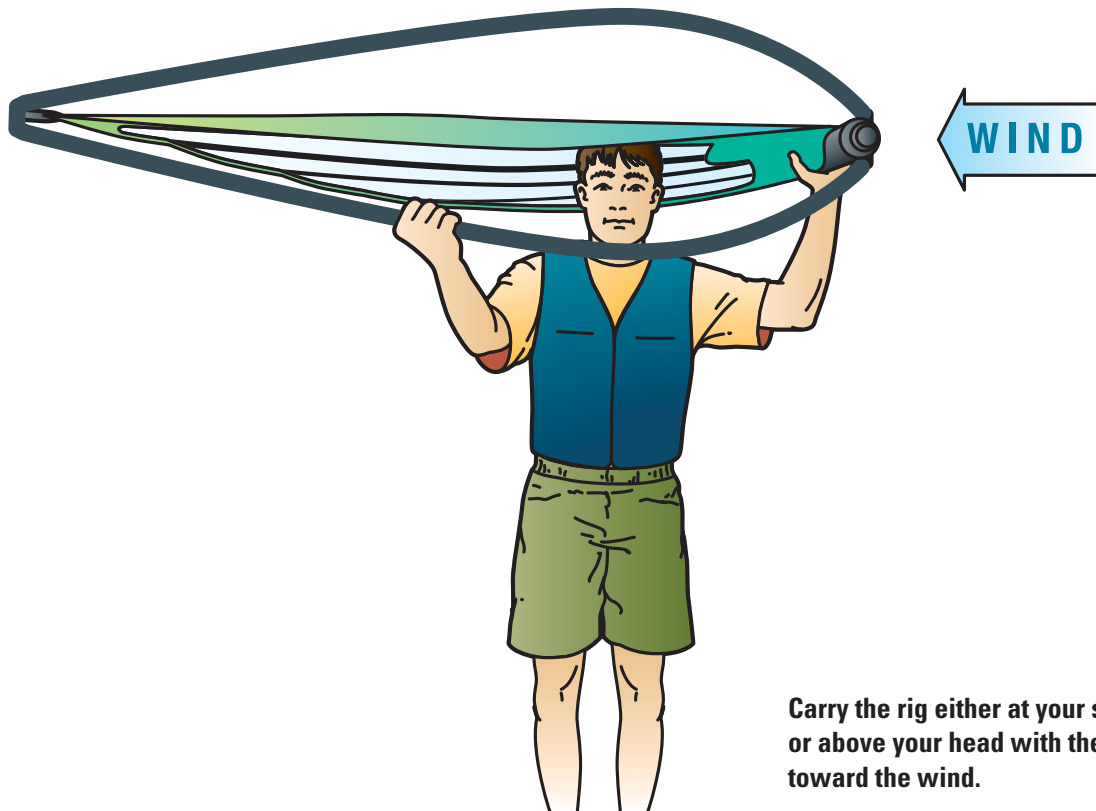

Carry the rig either at your side or above your head with the mast toward the wind.

Uphauling

Start with the board sideways to the wind with the rig on the downwind side. Face the board with your back to the wind and one hand on each side of the mast.

Boost yourself into a kneeling position over the center of the board. When stable, crouch with your feet on either side of the mast along the centerline of the board, grasp the uphaul, and carefully stand up.

Keep your back and arms straight, with your head up. Push up with your legs and lean back to slowly slide the rig from the water.

Finish pulling the rig from the water until you can grasp the mast with both hands just below the boom. Don't pull the mast completely vertical. Your body and the mast should form a V. Your back should still be to the wind with the sail flapping, or **luffing**, loosely downwind. Your front foot should be against the mast foot, and your back foot should be on the centerline behind the mast about shoulder width from your front foot. This is the **basic** position.

From the basic position, you can pause by lowering the rig, turn the board, or move to a **sailing** position. If the board starts to turn, the rig is leaning either too far forward or aft. Tilting the rig in one direction will cause the board to rotate in the other direction.

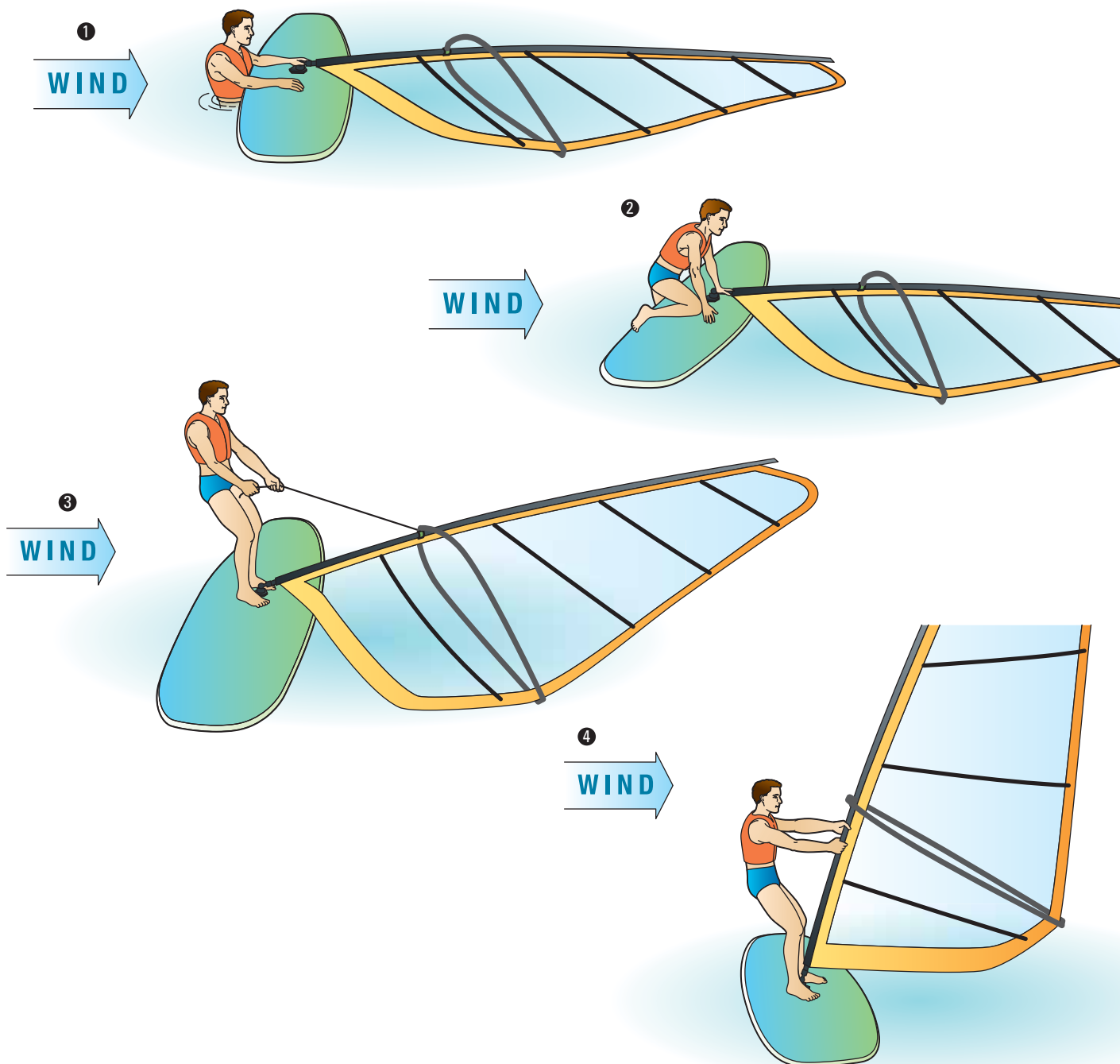

Getting Under Way

Experienced sailors move seamlessly into a sailing position during the uphaul by grasping the boom near the mast with their forward hand while adjusting their stance. The boom is then grasped with the back hand and pulled in to catch the wind. The actions are firm, but the body is relaxed.

The beginner may wish to start with a more deliberate progression. From the basic position, release the mast with your back hand. Step aft with your back foot across the centerline and your front foot angled forward just behind the mast. That rotates your body toward the front of the board and allows you to look forward.

Shift the rig to maintain balance. The sail should still be luffing with the rig tilted downwind.

Next, place both hands on the boom about shoulder-width apart with your hands on top. Your forward hand will be slightly aft of the mast. Pull the boom in with your back hand by rotating your rear shoulder away from the rig. The sail will catch the wind and the board will move forward.

With the wind from the side, pulling in on the boom will increase the force on the sail. Letting out will decrease the force. Let go with your back hand to luff the sail if you start to lose control.

Stay relaxed and lean back gently against the pull of the sail. Keep your body and arms straight in the shape of the number 7. Look ahead.

As the board accelerates, you may need to make slight adjustments to your stance or where you grasp the boom to maintain comfortable control and trim. Experiment with different positions in a light breeze. Some boards will be more forgiving than others.

Signs of poor positioning include: shoulders in with hips out, feet across the board, bent arms, arms too far apart, and head facing the sail near the rig.

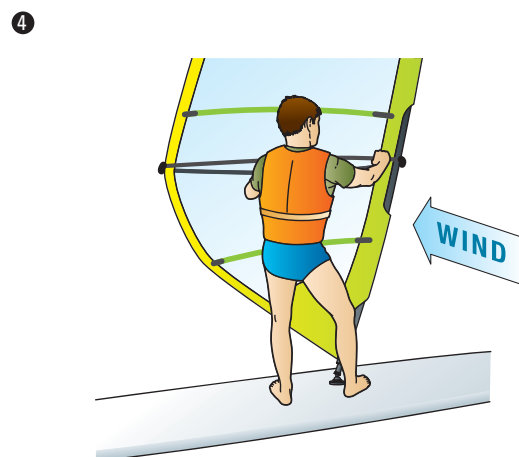
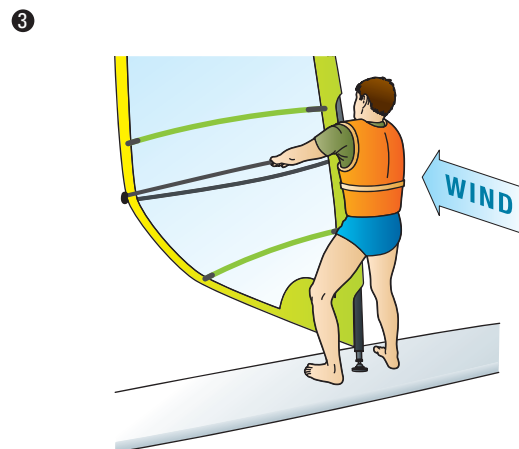
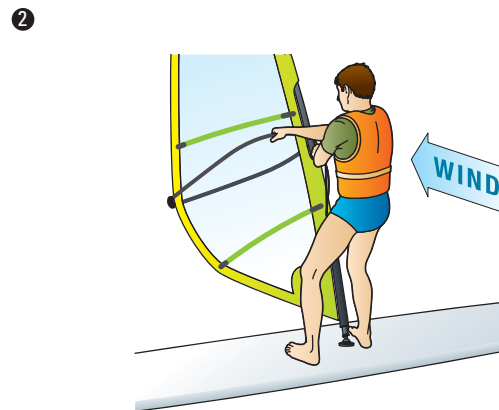
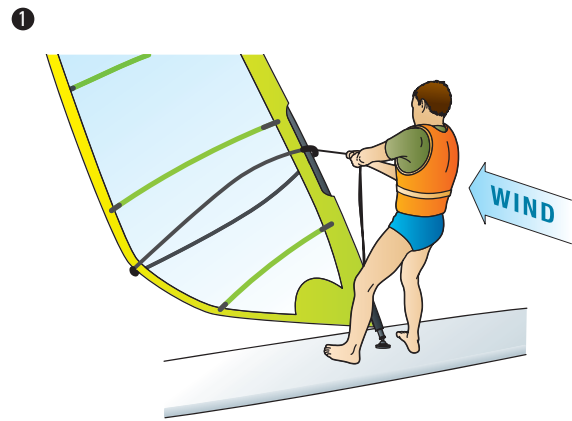

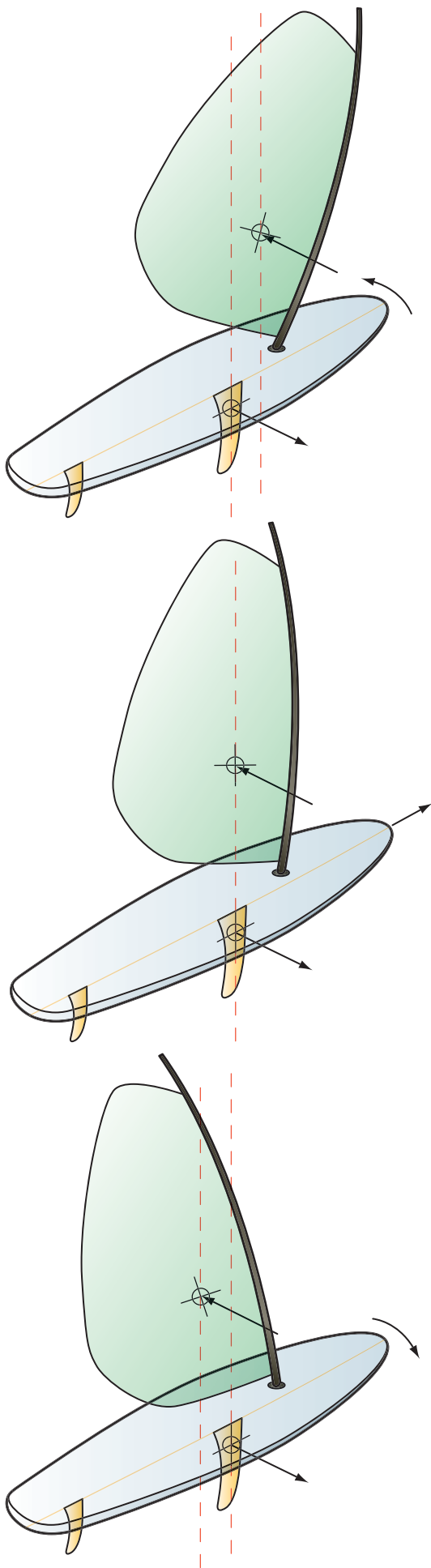

Steering

Since a sailboard has no rudder, steering is done by shifting the rig. When the wind strikes the sail at an angle, part of the force moves the board forward while part of the force tries to move the board sideways. Both force components act as if they were applied at a single point on the sail called the **center of effort (CE)**. The sideways, or lateral, force is countered by the resistance of the water on the fins. The water resistance acts at a point called the **center of lateral resistance (CLR)**. When the CE and CLR are directly above one another, there is a tendency for the board to heel that is countered by the sailor leaning to windward. However, the lateral forces are balanced and the board moves forward in a fixed direction. Tilting the rig forward shifts the CE ahead of the CLR, and the resulting moment of unbalanced forces causes the front of the board to turn with the wind. Tilting the rig aft shifts the CE behind the CLR, and the front of the board turns into the wind.

Turning Around

There are three different procedures for making major course changes or reversing direction. The board may be **tacked** by turning into the wind while under way. The sailor moves from one side of the board to the other by stepping around the front of the mast. Tacking is used to **beat** upwind and may also be used for reversing direction. Tacking is described in the next section.

Jibing is turning downwind while under way. The sail is flipped from one side to the other around the front of the board. Jibing is more difficult than tacking and will not be illustrated here because it is not required for Boardsailing BSA.

The third procedure is done from the basic position with the sail luffed. The rig is tilted forward and the board rotated beneath it. This procedure should be learned during your first sessions on the board—it is vital that you know how to return to your starting point. The technique is also useful for aligning the board in the direction of desired travel when you launch. You will not always desire or be able to proceed perpendicular to the wind as the getting under way sequence assumed.

To start the turn, luff the sail to cut power. After the board slows, grasp the mast or the uphaul with both hands. Then shift the rig so that it points toward the bow (actually, the board rotates under the rig).

As the board turns, keep one foot on each side of the mast and take small steps to turn the board as you continue to face the mast.

Once the board is pointing in the desired direction, return to the sailing position and adjust the boom for power.



Tacking

To turn without stopping, turn the board toward the wind. Grasp the mast with your front hand, lean the sail aft, and step forward across the board with your front foot.

As the board turns through the wind, grasp the mast with both hands and step forward with the back foot to face the rig. Twist around the rig on the balls of your feet, bring the mast upright, step back, grasp the boom, and resume a sailing position on the new side.

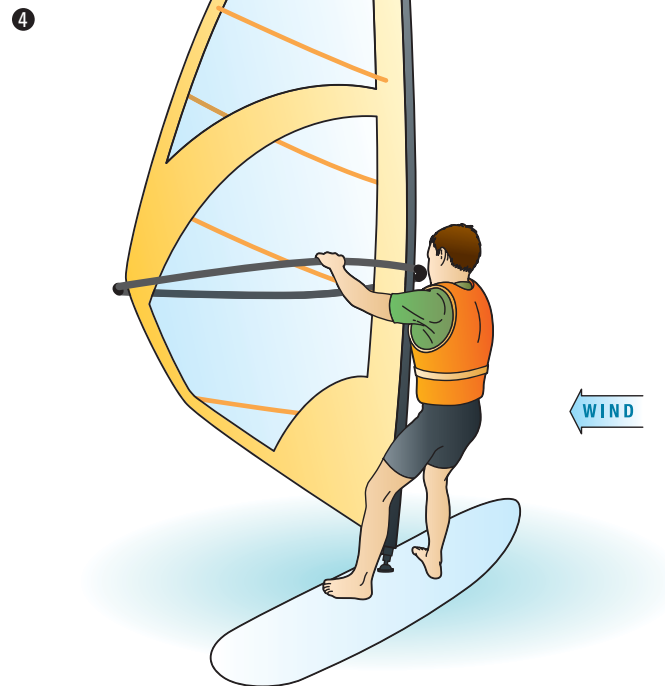
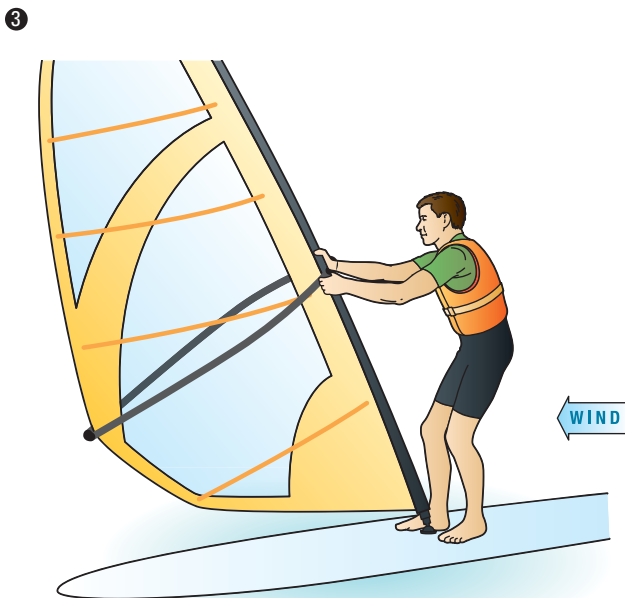
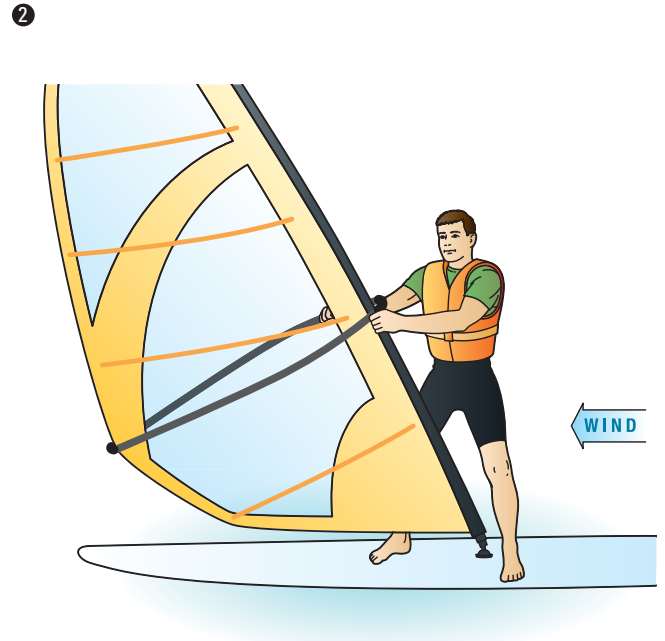

Points of Sail

The angle of the sail to the wind and the board depends on the heading relative to the wind. The board cannot travel directly into the wind. With the boom pulled parallel to the board, **sheeted in**, turn into the wind until the board starts to slow down or stall, then back off slightly. That's as tight to the wind as the board will go, which is often near 45 degrees. Traveling into the wind, called **beating**, will require a series of zigzag **tacks**.

To sail off the wind, or **reach**, let the sail out to maximize speed and minimize tilt. A **beam reach** is faster than the wind. The board is perpendicular to the wind with the sail out near 45 degrees.

To go directly downwind, or **run**, the sail is at 90 degrees to the board and you should be centered on the board, facing forward, with your back to the wind. Adjust your stance to balance the board, which may feel wobbly or unstable in this direction. The board can go no faster than the wind in this direction.

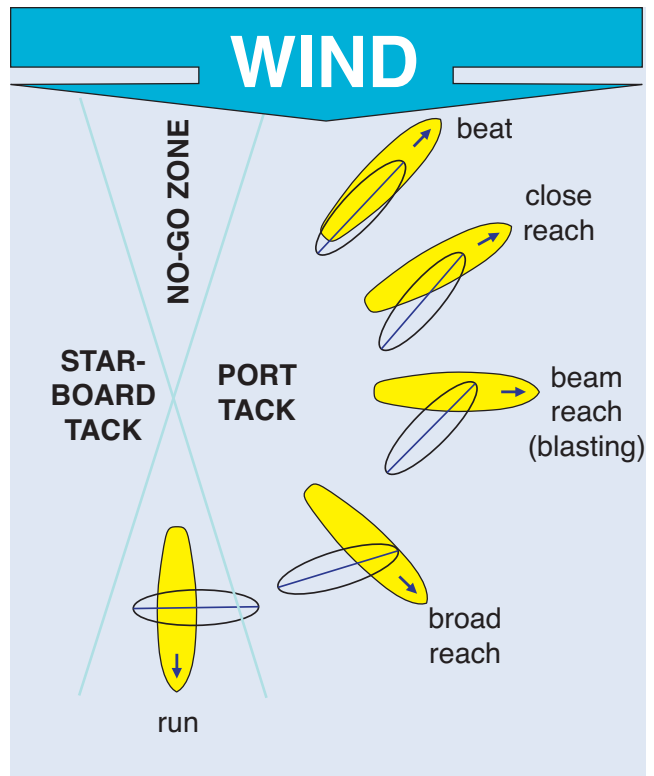

Stopping

As you near the shore, **sheet out** to slow down, and then let the rig luff as you coast the final distance. Carefully lower the rig into the water, which will stop any remaining forward motion. Crouch down as you lower the sail, and then step off the board.

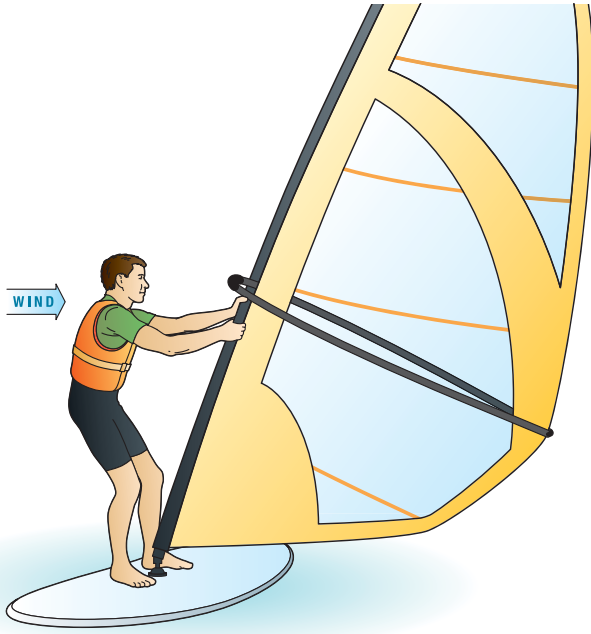

Emergencies

Even when you are careful, situations can arise that will require assistance. For example, a part of the rig could break. Since you should always sail with a buddy close at hand, such assistance should be easy to summon. One way to attract attention is to use a whistle. Always sail with a whistle attached to your life jacket. Another option is to flap your arms vertically in the international distress signal.

Falling off the board is an inevitable part of learning. Try not to fall headfirst, and try not to land on the board or the rig. Avoid foot entrapment between the mast and the board near the mast track. Raise your arms to protect your head from a falling rig. **Always stay with the board.** If the rig separates from the board, grasp the board first.

If you can't sail back to shore—for example, the rig or fin is broken, the wind has stopped completely, or the wind has strengthened beyond your comfort level—the prudent action is to signal for a rescue boat. For short distances, you can paddle to shore by lying prone along the board. Your buddy should follow close by. In light winds, balance the wishbone boom on the aft portion of the board to lift the sail clear of the water. Then lie prone on the forward portion of the board and paddle to shore. In heavier winds, dismantle the rig and roll the sail to make it easier to paddle or to take gear aboard a rescue boat. If you are paddling to shore, point upwind or upcurrent of your projected landing site.

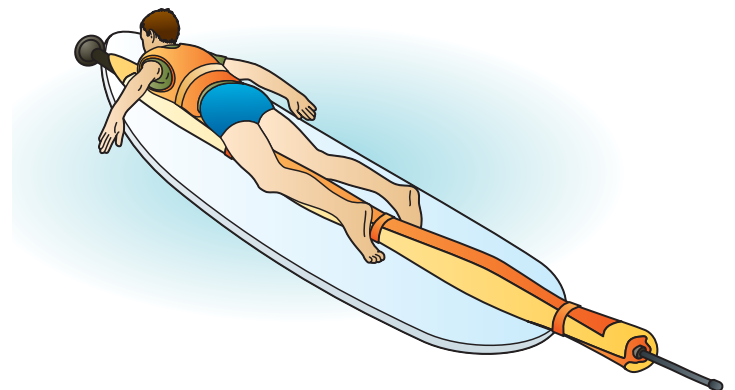
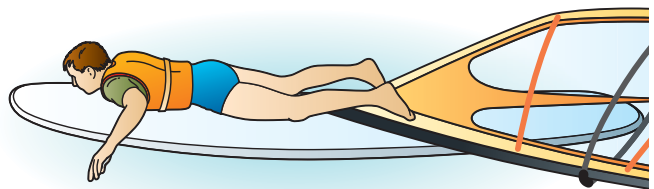

Be alert for other watercraft. With the rig down, the board may be difficult for others to see. (Yet another reason for a buddy board close by.)

Know the Environment

Sailing conditions vary with wind speed, the body of water, and other boat traffic. A small lake or a calm, enclosed bay free of other boats is an ideal area for learning. In such a setting, you should be able to reach shore along some direction even if you can't return to your launch site.

On large lakes or an ocean shoreline, beginners should not launch into an offshore wind. Stay close to shore in case the wind shifts direction or dies. In some areas, the wind will shift from offshore in the morning to onshore in the afternoon and die in the late afternoon. In other areas, afternoon thunderstorms are common during certain seasons. Get off the water in advance of thunder and lightning.

Be alert for shallow water and areas with underwater obstructions. In some parts of the country, trees are left upright in lakes formed by dams and may present underwater hazards.

Tidal currents are strong in some coastal areas, particularly in bays and in the channels between barrier islands. Currents may also be a factor in rivers large enough for boardsailing. Do not sail in situations where currents can carry you offshore or into areas of danger.

Beginners should avoid all but the smallest waves and surf. Wave sailing and other extreme aspects of the sport are only for the experts.

The environment also affects your physical comfort and well-being. Drink plenty of water to avoid dehydration in hot, humid conditions. Protect yourself against sunburn. Be wary of hypothermia. Return to shore if you begin to shiver. Wear shoes or booties to protect your feet.



Safety Guidelines

Whenever Scouts or Venturers participate in boardsailing activities, they must follow the complete Safety Afloat guidelines reviewed in Chapter 12. The following list highlights Safety Afloat items adapted for boardsailing and is consistent with various boardsailing safety codes. Individuals should follow similar procedures.

- 1. Qualified Supervision.** All boardsailing activity must be supervised by a mature and conscientious adult age 21 or older who understands and knowingly accepts responsibility for the well-being and safety of those in his or her care and who is trained in and committed to compliance with the nine points of BSA Safety Afloat. The supervisor must either be an experienced boardsailor knowledgeable in accident prevention and prepared for emergency situations, or be assisted by those with such experience.
- 2. Personal Health Review.** A complete health history from physician, parent, or legal guardian is required of all participants as evidence of fitness for boardsailing.
- 3. Swimming Ability.** Only persons who have completed the standard BSA swimmer classification test may ride on or control a sailboard. See Chapter 5 for a review of the test.
- 4. Life Jacket.** All persons must wear a properly fitted U.S. Coast Guard–approved personal flotation device while in or on the water during a boardsailing activity. A whistle should be attached to each life jacket.
- 5. Buddy System.** Each person on the water must have a buddy, either on another board or other type of craft, sailing close enough to monitor one another but far enough apart to avoid collision.
- 6. Skill proficiency.** Beginners should receive instruction in sailing skills and safety from an experienced boardsailor. Only participants who have demonstrated the ability to control the craft under existing wind and water conditions should be allowed to sail in open water. If needed, a triangular course may be used to test ability before allowing participants to set their own direction. Those who have trouble completing the course should receive additional instruction.
- 7. Planning and Safety**
 - Review local weather forecasts prior to the activity and monitor conditions while on the water.

- Do not sail where winds or currents are directed offshore into open water.
 - Stay off the water during high winds, high waves, or lightning.
 - Check all equipment before going out—yours and your buddy’s.
 - In case of equipment failure or distress, stay with the board.
 - Determine how to summon help before going out.
 - Use a float plan to advise others where you plan to sail and when you expect to return.
 - Plan to be off the water well before dusk. Do not sail at night.
- 8. Equipment.** All equipment should be safety checked and repaired as needed before each use. Personal gear should include a life jacket, a whistle, footwear, and adequate protection from heat or cold. A rescue craft is recommended for beginner groups. Beginners should avoid high-performance boards.
 - 9. Discipline.** All participants should know, understand, and follow the rules and procedures for safe boardsailing. The rules should be adapted to the local environment and reviewed with all participants at the water’s edge just before the activity begins.

What Next?

The material in this chapter reviews skills and safety items to support Boardsailing BSA training provided by a qualified instructor. Although Boardsailing BSA provides a basic introduction, there are additional skills used by advanced boardsailors. Again, the best way to learn is from someone with experience, whether just for fun or for competition. Jibing is an alternative way to turn. Foot straps and a harness allow better control of the board. For additional opportunities, check out the websites mentioned at the start of this chapter.





Chapter

25

Motorboating

A few Sea Scout units do training and extended cruising in large powered vessels, but for the most part, motorboating for Scouts and the public at large involves a variety of smaller boats including johnboats with small outboard motors, bass boats with large outboards, pontoon boats, multipurpose runabouts with stern drives, and inboards designed for waterskiing.



According to BSA policies, a motorboat may be operated by a youth, subject to state regulations, when accompanied in the boat by an experienced leader or camp staff member who meets state requirements for motorboat operation. Most states set a minimum age for motorboat operation—12 is most common but the range is from 10 to 16 for states with age restrictions. Many of the states with age restrictions also require an adult to be onboard when a minor is operating a motor vessel. More and more states are adding mandatory education and licensing requirements. In some cases, requirements also depend on the type of craft and horsepower. Some states recognize certificates from other states, some do not.

Because regulations differ from state to state, each leader supervising motorboat operation at a BSA function must check and comply with local state requirements. The website of the National Association of State Boating Law Administrators (NASBLA), www.nasbla.org, contains links to the appropriate agency in each state.

Some states offer courtesy rather than compulsory powerboat education courses specific to local regulations. The courses often can be taken over the internet as well as in person. In states without such offerings, there are various options for generic courses that follow NASBLA recommendations. Check the national websites for local chapters of the U.S. Coast Guard Auxiliary, www.cgaux.org, or the United States Power Squadrons, www.usps.org, for additional course opportunities. Such courses are recommended for BSA members who own and operate motorboats.

A typical course outline, adapted from NASBLA standards, provides a handy checklist for items that the powerboat operator should understand:



Required Boating Equipment

- Life jackets
- Fire extinguishers
- Backfire flame arrestors
- Ventilation systems (e.g., blowers for enclosed gasoline engines)
- Navigation lights for operation at night
- Sound signaling devices
- Visual distress signals

Trip Planning and Preparation

- Checking intended route (access, hazards, permits, alternate emergency destinations)
- Checking local weather and water conditions (low or high water; wave state)
- Filing a float plan
- Preventive maintenance and systems check
- Trailing
- Fueling procedures
- Predeparture checklist and tailgate review for participants

Environmental Laws and Regulations

Safe Boat Operation

- Operator responsibilities
- Capacity, trim, and passenger locations
- Adverse effects of alcohol and other drugs
- Rules of the road
- Aids to navigation
- Docking, mooring, and anchoring (don't anchor from stern)
- Carbon monoxide hazards (on swim platforms as well as in enclosed spaces)

Emergencies

- Capsize
- Man overboard
- Hypothermia and cold-water immersion
- Fire
- Grounding
- Rendering assistance
- Accident reports

Other Considerations

- Personal watercraft
- Tow sports (waterskiing, wakeboarding, tubing, etc.)
- Diving and snorkeling
- Hunting and fishing

Basic Powerboat Operation

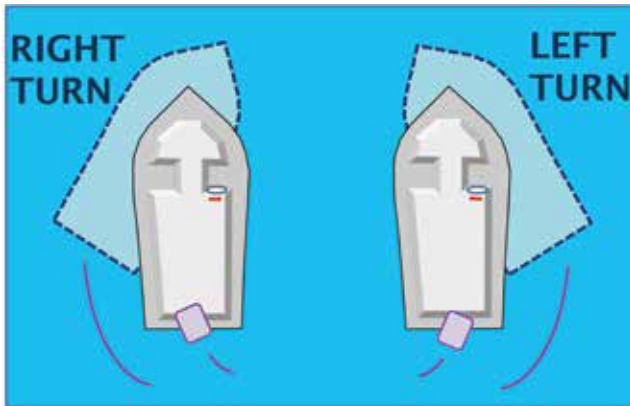

Many powerboat courses focus on cognitive material (that is, rules and procedures in a classroom) rather than physical demonstration and practice. The boat operator should have actual boating experience before transporting others.

Motorboat operation has similarities to driving a car, particularly if the boat has a steering wheel rather than a tiller. Even though a boat steering wheel is often on the right or starboard side, boats meeting head-on each veer to pass left-to-left, the same as cars on an unmarked country road. When boats are crossing, the boat to starboard has the right-of-way but needs to check that the other boat is acting accordingly. The same principles apply to cars at an unmarked intersection or in an open parking lot. (Review Chapter 15 for a more complete description of the rules of the road.) A car driver can lose control striking an obstacle

in the road, swerving to avoid an object, or hitting a bump at high speed. The same is true for a boater encountering a floating log or crossing the wake of another vessel.

A powerboat operator also needs to understand that driving a boat is different from driving a car. For example, a boat has no brakes. It either glides to a stop or is slowed more quickly by shifting to reverse, if available. A boat steers from the back rather than the front. A car will follow the front wheels away from a curb when pulling forward, whereas the front wheels will likely hit the curb if pulling away in reverse. In a similar situation, the back of a boat pulling forward away from a pier will swing into the pier.

Trailerling

Many boats are stored out of the water and transported on trailers to and from waterways. The size of the trailer will depend on the size and weight of the boat, including the engine and all gear transported in the boat. Trailers are rated by gross vehicle weight (GVW) and divided into classes. Class I is for trailers carrying less than 2,000 pounds. Larger trailers will have dual axles and may require separate trailer brakes. It is essential that the towing vehicle and hitch are rated for the trailer. Car manufacturers and insurance companies often restrict typical sedans and minivans to minimal towing loads. Larger vehicles can be purchased with special towing packages that include items such as additional cooling capacities,



heavy-duty brakes, and larger side mirrors. Four-wheel drive is useful on steep, slippery ramps.

The hitch should be attached to the vehicle frame. Hitches are rated not only on total towing capacity but also on tongue weight. A properly designed and loaded trailer should be balanced with minimal force either pushing down or pulling up on the hitch. Trailer balls come in different sizes and typically can be interchanged on the hitch. Make sure the ball matches the trailer coupling. The trailer should be attached to the hitch with criss-crossed safety chains as well as a ball.

Backing a trailer is an essential skill but can be tricky. Practice on open, level ground before attempting a steep, narrow ramp with a line of other boats waiting to launch.

Getting Under Way

Before starting a gasoline engine in an enclosed compartment, that is, for inboard and stern drive units, run the blower to clear any fumes that may have accumulated. If the boat is equipped with a safety shut-off lanyard, attach the lanyard to the driver before starting the engine.

Ideally, the boat should float free of the trailer, but in some cases it may be necessary to power the boat off. Make sure the prop is lowered to an operating position but is clear of the bottom. In most cases, the motor is started in neutral, but some small outboards may not have a gear-shifting mechanism.



Attach the safety lanyard and run the blower prior to starting the engine.

Passengers should wait to board until the driver brings the boat alongside the floating piers that generally are provided for that purpose. (Don't forget the person parking the trailer.) Passengers should don life jackets, board one at a time, and sit in positions indicated by the driver. Everyone should have a seat. If there are more passengers than seats, except perhaps for a toddler sitting on a parent's lap, the boat's design capacity has been exceeded and it will be necessary to take turns. Don't overload the boat or allow passengers to ride on the sides. Review basic safety precautions before leaving the dock. Everyone should remain seated while the boat is under way.

Planing

Displacement mode



Plane mode



Most small powerboats are designed to **plane**. At low speeds, the boat operates in **displacement** mode: the bow pushes water to the sides while causing significant friction. At higher speeds, the back of the boat glides on top of the water. Motor away from the dock at low speeds—the boat will generate a significant wake while reaching a plane. Once in open water out of no-wake zones, slowly but continuously open the throttle to generate more power. The boat may initially ride high on a bow wave but should quickly level off after reaching planing speed. Slowly back off the throttle to your desired cruising speed. It takes more power to reach a plane than to maintain it. Power-to-speed ratios can be adjusted with power trim tabs in boats so equipped. In most situations, the stern unit should be lowered such that the prop shaft is nearly parallel to the water when at rest. If the unit is lowered too far with the prop shaft angled up, the bow of the boat will plow and may not achieve a plane. If the unit is not lowered enough, the boat squats, and steering while on a plane may be compromised.

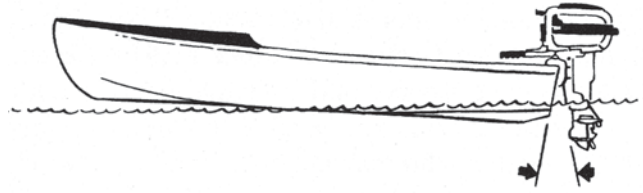

When the motor is at too much of an angle, the boat “squats.”

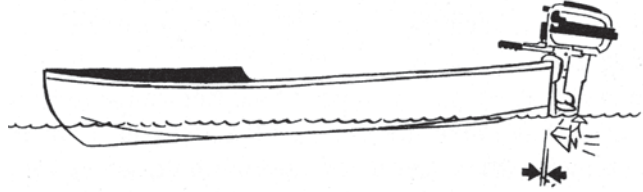

When the motor is not placed at enough angle, the boat “plows.”

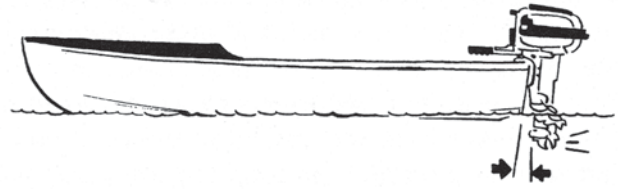

When the motor is placed correctly, the best performance will be obtained.

Turning



Although many powerboats will remain upright during sharp turns at speed on flat water, it is generally better to make gentle turns while planing and limit tight turns to slow speeds. Turn the wheel or tiller slowly, rather than putting it hard over. While turning, the back of the boat will swing wide. Flat-bottomed boats may skid at higher speeds, particularly if towing a skier. Remember to always keep the boat under control. Avoid situations where sudden turns are needed by not outrunning your ability to see ahead.

Waves and Wakes



One potential consequence of a high-speed turn is that a sharp turn into the trough of a wave could cause the boat to flip. Small swells from the side will rock the boat slightly but shouldn't cause a problem at normal operating speeds. If possible, alter course to take large, isolated waves from the wakes of passing boats at an angle, and then resume your previous heading. Large continuous waves should be taken at a slight angle off perpendicular. Decelerate off a plane if control is lost due to pounding. Deep V hulls with an enclosed foredeck and high freeboard will manage waves better than a small open outboard, but the best way to handle large waves in any boat is to get off the water before they develop. Remember to always check the weather forecast before going out

and to keep an eye on the sky. Head back to the marina if adverse weather is moving your way. In a pinch, if the waves are large enough to jeopardize control or to bring in water over the sides, temporarily forgo heading to the marina and try to maintain sufficient power to keep the boat headed into the waves at a slight angle.

Stopping

If you suddenly put the engine in neutral while planing, the boat will not immediately stop but will slow down quickly enough to throw your passengers forward. In addition, your wake will continue forward and may spill in over the stern. Plan ahead sufficiently so that you can slowly reduce speed. An easy, controlled stop will take several hundred feet if you are traveling fast. As you reduce throttle, the boat will come off the plane. Continue to reduce throttle to avoid running at intermediate speeds just below planing. At those speeds, the bow lifts, which interferes with visibility, and a large wake is generated. As you approach a dock or trailer, it's a good ideal to kill all forward momentum a boat length or two away by short bumps into reverse at low power. You can then proceed at the boat's slowest forward speed with a final short bump into reverse if needed. Note that the rudder on an inboard allows some steering capability if the boat is gliding forward in neutral. However, outboards and stern drives rely on the prop for steerage. Turning the wheel in neutral will not have much effect.

You should be skilled enough to bring your boat to a stop at the side of a pier or in a slip. In unfavorable winds or currents, you may need to rely on a fender to absorb the final momentum or a boat hook to close the final gap. Throwing a line to someone already onshore may also be handy. However, you should not expect or allow passengers to jump off a moving boat or to grab a post to stop the boat from crashing into the pier.

Personal Watercraft



The initially poor safety record and nuisance complaints associated with personal watercraft have been moderated with education, supervision, regulation, and design changes. With approval from the National Council, several local councils have conducted popular and responsible operator training programs. Any council may now apply to the National Council for approval to conduct a personal watercraft (PWC) camp program. Consult National Camp Accreditation Program (NCAP) standards for details. However, unit use of personal watercraft by youth is not an authorized BSA activity. Check the online *Guide to Safe Scouting* at www.scouting.org for current policies. Individuals who operate private personal watercraft should note that the Personal Watercraft Industry Association recommends operator training and a minimum operator age of 16 even though regulations in several states are less restrictive. Safety guidelines are available at www.pwia.org and www.uscgboating.org.

Four-Cycle Outboards

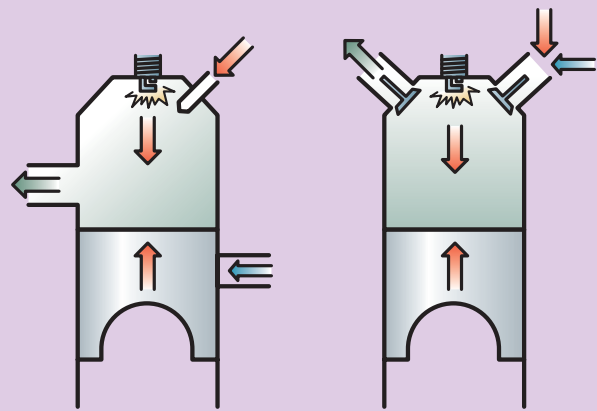

TWO CYCLE

FOUR CYCLE

The standard for small outboard motors with a single piston has shifted from two-cycle to four-cycle operation. The newer versions may be slightly more expensive with a bit more bulk for motors with the same horsepower. However, a four-cycle motor has better fuel efficiency and less adverse environmental impact. Some states have restricted the use of two-cycle engines, and manufacturers have shifted emphasis to four-cycle versions.





Tow Sports

Tow sports in the aquatics environment include any activity in which a person is pulled in or above the water by a line attached to a power source. The typical power source is a motorboat but could be a sailboat or a kite. Tow sports include riding on flotation devices, waterskiing, kneeboarding, wakeboarding, parasailing, and kitesurfing. The last two activities are not authorized as BSA youth activities.



All participants in towed activity afloat must have successfully completed the BSA swimmer classification test and must wear a life jacket with an impact rating consistent with the activity. Supervision must include both a skilled boat driver and a separate observer. (A rearview mirror is recommended for the driver and meets minimal regulations in some states, but does not substitute for the observer required by BSA policies.)

The skills needed by individuals participating in towed activities vary from simple to difficult. In many cases, the activity itself will have components ranging from basic to extreme. The activity leader should not allow participants to attempt maneuvers without appropriate training, or maneuvers of questionable safety. Basic waterskiing skills are discussed in the *Water Sports* merit badge pamphlet. USA Water Ski is the national governing body for competitive waterskiing, and links to training programs for waterskiing, wakeboarding, and kneeboarding can be found at www.usawaterski.org.

Tow sports and devices are continually evolving. Some products are introduced and then recalled due to poor safety records. In the absence of a specific BSA policy, the unit leader is responsible for making reasonable judgments about an activity's safety, age appropriateness, and training requirements based on the leader's own experience. Questionable activities should be curtailed or postponed until appropriate trained supervision becomes available.



Water-Skier's Safety Code



The following items support safe, enjoyable waterskiing and also apply to wakeboarding and kneeboarding:

- Always learn to water-ski by taking instructions from a good water-ski instructor or an advanced skier.
- Always wear a personal flotation device when skiing. Before entering the water, make sure your life jacket is adjusted correctly for safety, comfort, and freedom of movement. Always make sure your life jacket is in good serviceable condition.
- Always look ahead and know where you are going at all times.
- Always stay away from solid objects such as docks, boats, and stumps.
- Always be courteous and stay a reasonable distance from other skiers, boats, and swimmers.
- Always run parallel to shore and come in slowly when landing.
- Always learn new maneuvers progressively.
- Always have an extra person in the boat to watch the skier.
- Always signal that you are all right after a fall by clapping your hands overhead to notify the driver and observer.
- Always hold up a ski while waiting in the water in a well-traveled boating area.
- Always check your equipment for dangerous, sharp, or protruding objects (wing nuts, loose runner, slivers).
- Never ski in shallow water or in an area where you do not know the depth. Minimum safe depth is 6 feet.
- Never put any part of your body through the bridle or wrap the rope around any part of your body.

- Never yell “Hit it!” or “Go boat!” until the rope is tight and the tips of your skis are up.
- Never ski to the point of exhaustion.
- Never ski at night. (Almost all states prohibit skiing from dusk to dawn.)
- Never ski directly ahead of another boat.
- Never ski double with different lengths of rope.
- Never attempt fast landings directly toward shore.
- Never jump from the boat while it is moving.
- Never climb into the boat or approach the stern of the boat while the motor is running. Always use a stern platform or ladder when climbing into the boat.



Skier safe



Skier in water

Role of the Observer

The safety observer watches how the skier, boarder, or float rider is doing; relays signals both ways between the participant and driver; tells the boat driver if the participant falls; watches for potential hazards; and helps the driver stay aware of traffic approaching from the rear.

The observer and skier should review signals before the skier enters the water. Although signals are fairly standard, they vary slightly in some regions. For example, some people indicate a turn by circling a hand overhead and then pointing in the desired direction, others simply point, and some employ the straight- and bent-arm signals used for bicycles. Agree on signals under way for OK, stop, faster, slower, right turn, left turn, and return, and make sure the skier knows to quickly use the skier safe signal after a fall.

The observer is also in charge of the towrope. The observer coils the line into the boat when the skier is ready to board, pays it out when necessary for deepwater starts, and makes sure the line is clear prior to starts.



Faster



Slower



Cut motor or stop



Home

Boat Driver's Safety Code



The driver looks ahead while the observer watches the skier. The ski buddy sits low and out of the way.

The boat driver should never forget that he or she is not driving for personal pleasure. The boat is operated solely for the benefit and safety of those being towed. All boat drivers should observe the following:

- Always have an observer onboard to watch the participant(s).
- Always return quickly to protect a fallen person, who is helpless in the water against oncoming boat traffic. Anyone being towed is your primary responsibility.
- Always drive according to the participant's ability, and avoid sharp turns.
- Always put the motor in neutral when passing a person in the water.
- Always turn the motor off when picking up a person.
- Always use common sense and courtesy when driving.
- Always take a swimmer into the boat using a ladder or low rear deck, avoiding any contact with the motor, rudder, or drive.
- Never ride the gunwale or the back of the seat while driving and do not allow passengers to ride that way.
- Never tow anyone in congested areas, particularly swimming areas.

Safe Boat Maneuvers

Keep passengers in the towboat to a minimum. Passengers other than the observer and the skier's buddy may distract the driver. In a low-powered boat in particular, unnecessary passengers make good starts more difficult.

Although a skier or boarder may request a takeoff by shouting "Hit it!" the boat driver should not respond without clear water ahead for a considerable distance. The acceleration should not be so abrupt as to jerk the line from the skier, but the boat will need to proceed quickly to a plane, from which the driver should throttle back to a speed that matches the skier's ability and desire. The driver should also avoid a turn during the takeoff by checking that the towrope, the centerline of the boat, and the prop axis are all approximately aligned. That check is normally done when taking the slack out of the line.

The towboat should proceed in a straight line at uniform speed except when turning to reverse direction or pick up a fallen participant. Fishtailing or rapid speed changes intended to upset a skier or to dislodge a rider are irresponsible and inappropriate.

Ideally, the towpath should be clear of obstructions or other vessels for roughly 100 feet to each side and at least a quarter-mile long. Other boats should stay clear of a boat and riders being towed. However, the tow driver should be prepared to take appropriate evasive action (either a wide swerve or a controlled stop) if other boats continue on a crossing path.

Turns at the ends of a run should be a wide oval to avoid pulling the participant through the boat wake. After the turn, the towboat should proceed back along its previous wake. At times, skiers may intentionally cross the wake either during a straight run or during a turn. However, the actions of the boat driver should not force the participant to cross the wake. Water is typically smoother inside the wake if there is chop on the open lake due to wind and other boat traffic, and crossing the wake can be intimidating for a beginner.

When a skier falls, the driver, through the observer, should make certain the skier is all right and return as quickly as safety permits if the skier fails to give the "safe" signal.

If the skier is all right, the driver should turn and idle back toward the skier, approaching to pass on the driver's side

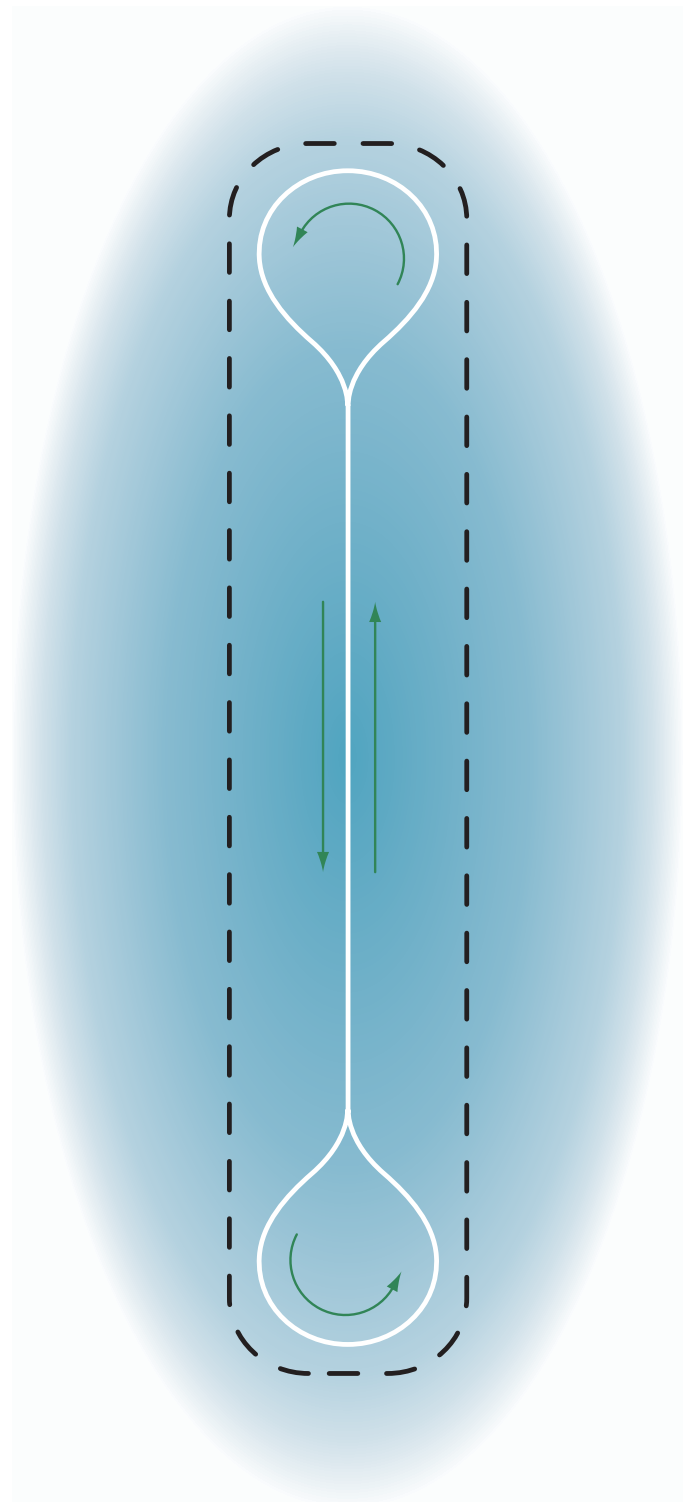

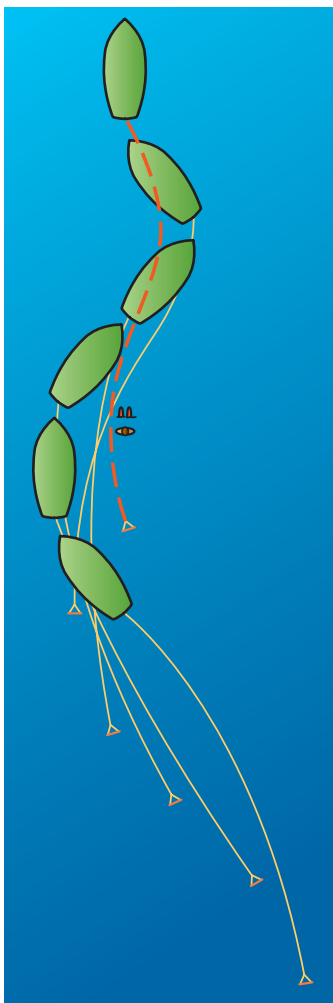

for best visibility. As the boat approaches the skier, the observer asks if the skier wishes to go again. If not, the driver kills the engine and coasts abreast the person, staying far enough away that the boat does not glide or blow into the person. If boarding is from the stern, caution the skier to avoid sharp edges on any exposed drive mechanism. Turning an outdrive away from the boarding ladder may help.

To continue the run, the driver pulls abreast of the skier, but still at least 10 to 12 feet away, and then starts a sharp turn around the skier at idle speed. If the driver continues to turn in a half circle completely around the skier, the boat will be positioned to continue in the same direction it was going when the skier fell.

Alternatively, if the driver starts a tight turn around the skier followed by a sharp turn in the opposite direction, the S-shape course will bring the towline close to the skier. The new course will be reversed relative to the previous run.

Towed Flotation Devices (Tubing)

The roles and responsibilities of the boat driver and observer while towing riders on a float are similar to those while towing people on water skis or wakeboards.



Persons on flotation devices should be towed at slow speed well away from any obstacles. A prudent speed depends somewhat on the design of the float, that is, how secure the passengers are, and the age and comfort level of the participants. The driver should immediately honor any requests to slow down, even if given contradictory instructions by other riders. The driver should also ignore requests for greater speeds at which the float becomes unstable. Only use floats specifically designed for towing. Each rider should have a secure grasp on the device, not on another rider. Don't rig makeshift floats using car or truck tire inner tubes.

The number of riders on a float plus the number of people in the towboat, which must include at least the driver and an observer, must not exceed the towboat's rated occupant capacity. Given that requirement, the easy way to start the tow and retrieve riders is in deep water away from congested beaches or launch areas. That avoids potential problems with trying to tow the device into shallow water or to a pier for riders to board and disembark.



If more than one person is on the float, and one falls off, the others should remain with the float while the boat turns to retrieve the fallen passenger. The procedure is similar to picking up a fallen skier. Make sure riders know to use the hands-overhead “safe” signal.

“Skier Down” Flags

Some states require the towboat to display a 12-by-12-inch orange flag when the boat is moving to pick up a fallen skier, boarder, or float rider. Because regulations differ from state to state, each leader supervising a towing activity during a BSA function must check and comply with local requirements. The website of the National Association of State Boating Law Administrators, www.nasbla.org, contains links to the appropriate regulatory agency in each state.



Unauthorized Activities

Parasailing is a popular concession at many resort areas. A patron is lifted high above the water wearing a parachute while being towed by a boat. In some cases, the participant is winched down to a platform on the back of the moving craft and never enters the water. Parasailing and other aerial activities such as static parachute jumps, skydiving, paragliding, and hang gliding are not authorized youth activities for BSA groups.

Kitesurfing is somewhat similar to wakeboarding except the towline is pulled by a kite held by the rider rather than a motorboat. Even though modern rig designs have led to increased control, control is still uncertain and there is a reasonable expectation that the participant will become airborne, either accidentally or intentionally. It is not unusual for a participant to be pulled off the board. Therefore, some users attach themselves to the board with a lanyard. However, head injuries, even when a helmet is worn, sometimes result from the lanyard pulling the board into the participant. In some areas, there have been problems with overhead obstructions, such as power lines. This sport is not an authorized BSA youth activity.



Review Questions for Section III

1.0 List the nine points of Safety Afloat.

- 1.
- 2.
- 3.
- 4.
- 5.
- 6.
- 7.
- 8.
- 9.

2.1 All adult supervisory personnel for a boating activity must be over 21.

T F

2.2 According to both Safety Afloat and Youth Protection guidelines, there must be at least two adults for any activity afloat, with one over 21.

T F

2.3 The ratio of supervisors to participants is 1-to-10 for Boy Scouts and Cub Scouts.

T F

3.1 Life jackets must be worn by everyone during all small-boat activities.

T F

3.2 Adults on BSA float trips may safely store life jackets close at hand on calm water.

T F

3.3 Exceptions to life jacket use are allowed for vessels over 20 feet in length.

T F

4.1 No youth may control any boat without first completing three hours of skill instruction.

T F

4.2 Participants on an extended float trip must demonstrate basic proficiency or complete three hours of skill instruction.

T F

4.3 Buddy tags must be used to account for everyone participating in a boating activity.

T F

5.1 All participants on whitewater treks with rapids rated higher than Class II must have specialized training.

T F

5.2 Youth may only operate a sailboat with an adult or camp staff member onboard.

T F

5.3 Youth may only operate a motorboat with an adult or camp staff member onboard.

T F

6.1 Which type of life jacket is recommended for most recreational boating activities?

- A. Type I—offshore life jacket
- B. Type II—nearshore buoyant vest
- C. Type III—flotation aid
- D. Type V—special-use device

6.2 Certified inflatable life jackets are Coast Guard–approved:

- A. When worn
- B. For users at least 16 years old
- C. In non-impact situations
- D. All of the above

6.3 For proper life jacket fit:

- A. Check the size label
- B. Lift the straps at the shoulders
- C. Fasten all buckles, straps, or zippers
- D. All of the above

7.1 Which statement is incorrect?

- A. Hypothermia is a dangerous drop in body core temperature.
- B. Hypothermia impairs mental and physical capabilities.
- C. Hypothermia is only a concern in northern climates or in rivers fed by snow melt.
- D. An unprotected boater falling into water near freezing is impaired almost immediately and may die within minutes.

7.2 Progressive symptoms of hypothermia are

- A. Unconsciousness, shivering, death
- B. Shivering, impaired judgment, loss of dexterity
- C. Slurred speech, clumsiness, shivering
- D. Muscle rigidity, inward behavior, loss of dexterity

7.3 The best prevention for immersion hypothermia is

- A. Wear a wet suit
- B. Assume the H.E.L.P. position
- C. Get out of cold water immediately
- D. Avoid immersion in cold water

8.1 If a person is facing forward in a boat headed downstream, the direction to the right is

- A. River left
- B. Starboard
- C. Port
- D. Onside

8.2 Which terms in order denote the front and back of a boat?

- A. Transom, bow
- B. Bow, stern
- C. Port, gunwale
- D. Starboard, aft

8.3 If the _____ reduces significantly when a boat is loaded, the load may be too heavy.

- A. Gunwale
- B. Freeboard
- C. Draft
- D. Sheer

9.1 A canoe is more stable when a passenger is sitting on the bottom rather than standing.

T F

9.2 A boat that is stiff is always harder to tip over than a boat that is tender.

T F

9.3 A load may safely exceed a boat's rated capacity if the boat is operated only at slow speeds.

T F

10.1 The most general navigation rule for boats on a collision course is

- A. Red, right, returning
- B. Commercial boats yield to private boats
- C. More maneuverable yields to less maneuverable
- D. Boat on the right is always right

10.2 Which of the following is not true?

- A. Powerboats meeting head-on each veer to the right.
- B. When powerboats are crossing, the boat to starboard has the right-of-way.
- C. A sailboat has the right-of-way when overtaking a powerboat.
- D. Private craft must stay clear of military vessels.

10.3 Boaters should stay clear of areas marked with

- A. A white buoy with a crossed diamond
- B. A white buoy with a diamond
- C. A red flag with a diagonal white stripe
- D. All of the above

11.1 All states require all boats to be registered.

T F

11.2 Any boating accident during a BSA activity involving significant injury must be reported to both law enforcement and the local council.

T F

11.3 Access to public waterways is unrestricted.

T F

- 12.1 Canoeists should maintain three points of contact when moving in the boat.**
T F
- 12.2 Paddling from a kneeling position is inefficient, uncomfortable, and generally poor form.**
T F
- 12.3 Canoeists should both paddle on the same side and switch sides in unison to maintain a straight course.**
T F
- 13.1 A draw and a pry in unison from opposite sides move the canoe sideways.**
T F
- 13.2 A draw and a pry in unison from opposite sides pivot the canoe.**
T F
- 13.3 Forward sweeps in unison from opposite sides pivot the canoe away from the onside.**
T F
- 14.1 After a canoe capsizes, boaters generally should abandon the boat and swim quickly to shore to prevent hypothermia.**
T F
- 14.2 The first concern after capsizing is the safety of the boaters.**
T F
- 14.3 To rescue a swimmer, approach in a canoe so that the swimmer makes contact amidships at the widest, most stable point.**
T F
- 15.1 Use a "J" at the end of each kayak stroke to maintain a straight course.**
T F
- 15.2 Feathering while kayaking requires a no-slip grip with both hands.**
T F
- 15.3 While kayaking, power is applied through the paddle by rotating the torso.**
T F
- 16.1 Kayaks automatically right themselves after capsizing if the paddler maintains position.**
T F
- 16.2 A capsize drill is a useful safety precaution prior to additional instruction in a decked kayak.**
T F
- 16.3 A wet exit is more difficult with a narrow cockpit and a spray skirt.**
T F
- 17.1 Which of the following is not a safety concern on a river?**
A. A strong current
B. A rip current
C. A strainer
D. A low-head dam
- 17.2 When rounding a bend in a river, the current strength and water depth will be greatest**
A. On the inside of the bend
B. In the middle of the channel
C. On the outside of the bend
D. Unpredictable
- 17.3 Strainers are most likely to lie**
A. Near the cut bank on the outside of a bend
B. In the shoals on the inside of a bend
C. In the middle of the channel
D. Just below the surface moving with the current
- 18.1 Any river flow above 1,000 cfs is dangerous.**
T F
- 18.2 A low-head dam can be safely run if paddlers lean back in their craft to keep the bow up as it crosses the lip.**
T F
- 18.3 The best way to control a craft in a current is to match the speed of the current.**
T F

- 19.1 If a boater loses contact with the boat during a capsize in warm water, the swimmer should**
- Try to stand up in the current
 - Float feetfirst downstream while moving toward shore
 - Swim headfirst downstream while moving toward shore
 - Swim directly for the nearest strainer
- 19.2 If a boater capsizes in a narrow, very cold river, the swimmer should**
- Try to stand up in the current
 - Hold to the back of the boat
 - Float feetfirst downstream
 - Get out of the water as soon as safely possible
- 19.3 If a capsized boater is unavoidably swept into a strainer, the swimmer should**
- Dive underwater to pass beneath
 - Fend off the object while floating feetfirst
 - Assume a headfirst position and try to climb up onto the object
 - Swim upstream to ferry around the object
- 20.1 Riding tubes or other floats down a lazy river is allowed for all ages and all ability groups.**
- T F
- 20.2 Only swimmers may ride floats on a river.**
- T F
- 20.3 Life jackets are not needed because tubing on a river is a swimming event rather than a boating event.**
- T F
- 21.0 Participants in whitewater treks in rapids rated at Class III or above must**
- Have special training in whitewater if controlling the boat
 - Ride as a passenger in a boat controlled by a trained guide
 - Always wear a helmet
 - All three apply
- 22.1 A whitewater canoe or kayak generally differs from a touring model by being**
- Shorter, with a flatter bottom
 - Shorter, with more rocker
 - Longer, with a flatter bottom
 - Longer, with more rocker
- 22.2 Which of the following whitewater features should be avoided?**
- An open V (point downstream)
 - A closed V (point upstream)
 - Standing waves
 - Eddies
- 22.3 Which of the following whitewater features is generally the least hazardous?**
- A hole
 - A drop
 - Shoals
 - An undercut
- 23.1 Major or unfamiliar rapids should be scouted from shore.**
- T F
- 23.2 In general, plan a route by scouting from the top of the rapid to the end.**
- T F
- 23.3 Features seen from a high bank may be difficult to spot at river level.**
- T F
- 24.1 When scouting a rapid, the party must choose between everyone running the rapid and everyone portaging the rapid.**
- T F
- 24.2 If the trek leader is not confident that the skill of the participants allows an adequate margin of error, then those participants should portage the rapid.**
- T F

- 24.3** If the trek leader determines that the likely consequences of a mishap are acceptable, then each individual still decides whether or not to run that rapid.
T F
- 25.1** Cub Scout dens may not conduct overnight float trips.
T F
- 25.2** Swimming ability is not an important consideration during float-trip preparation since all participants will wear life jackets.
T F
- 25.3** A unit with only Class II skills may not consider a float trip on a river with even a single Class III rapid.
T F
- 26.1** River guidebooks are often unreliable and should not be consulted when planning a float trip.
T F
- 26.2** River guidebooks should be reviewed, but first-hand experience is better.
T F
- 26.3** Boat livery companies are often good sources for equipment, shuttles, and general information.
T F
- 27.1** Because of shuttle concerns, large groups are better transported in multiple private cars rather than a single bus.
T F
- 27.2** Large numbers of boats are best transported on a trailer rather than car-topped.
T F
- 27.3** An easy way to handle a shuttle is to have drivers who do not travel downriver.
T F
- 28.1** Which of the following is the least useful on a float trip?
A. Stout, no-slip footwear that can get wet
B. Hooded rain jacket rather than a poncho
C. Cell phone
D. iPod
- 28.2** What is the preferred way to distribute gear?
A. Each person packs to be totally self-sufficient
B. Group gear and provisions (tents, stoves, food) are packed with all like items together with each category carried in a different boat
C. Critical gear and provisions are divided into two or three packs and carried in different boats
D. Each item is packaged and loaded separately in waterproof containers that float
- 28.3** Which is an important consideration when loading a boat?
A. Easy access to important gear (water, cameras, first aid supplies)
B. Manageable portage loads
C. Boat trim
D. All of the above
- 29.1** When traveling on the water, experienced crews lead and inexperienced crews follow at the end.
T F
- 29.2** Only the lead boat needs to carry a route map.
T F
- 29.3** Avoid traveling across open water with the wind at your back.
T F
- 30.** Which best describes a float plan?
A. A simple alert mechanism if a party is overdue
B. A complete itinerary shared with the immediate party and those at home
C. Emergency contact procedures to and from the crew in case of trouble
D. All of the above
- 31.** A common problem with rowing technique is the use of oars that are too long for the boat.
T F

32. During the rowing stroke, the hands should trace out vertical circles.
T F
33. Oarlocks, other than on outriggers, should be lowered when not in use.
T F
34. Several BSA high-adventure bases offer captained sailboat cruises.
T F
35. Small-boat sailing experience qualifies a leader to skipper a cruising sailboat.
T F
36. Modern navigation aids eliminate past concerns with sailing at night and out of sight of land.
T F
37. All sailboards are well-suited to both learners and experts.
T F
38. Offshore winds allow beam reaches parallel to the shore and are favorable for boardsailing.
T F
39. Scouts earning the Motorboating merit badge at camp are generally exempt from state licensing requirements.
T F
40. Motorboats on converging paths yield right-of-way similar to cars.
T F
41. Motorboats steer the same as cars.
T F
42. A rearview mirror is an adequate substitute for an observer when a motorboat is towing a person.
T F
43. The towpath should be clear of obstructions and other boats for 100 feet to each side.
T F
44. Some states require "skier down" flags.
T F
45. Which of the following is an authorized BSA activity at the unit level?
A. Personal watercraft operation
B. Towed flotation devices
C. Parasailing
D. Kitesurfing

Program Delivery

Section

IV

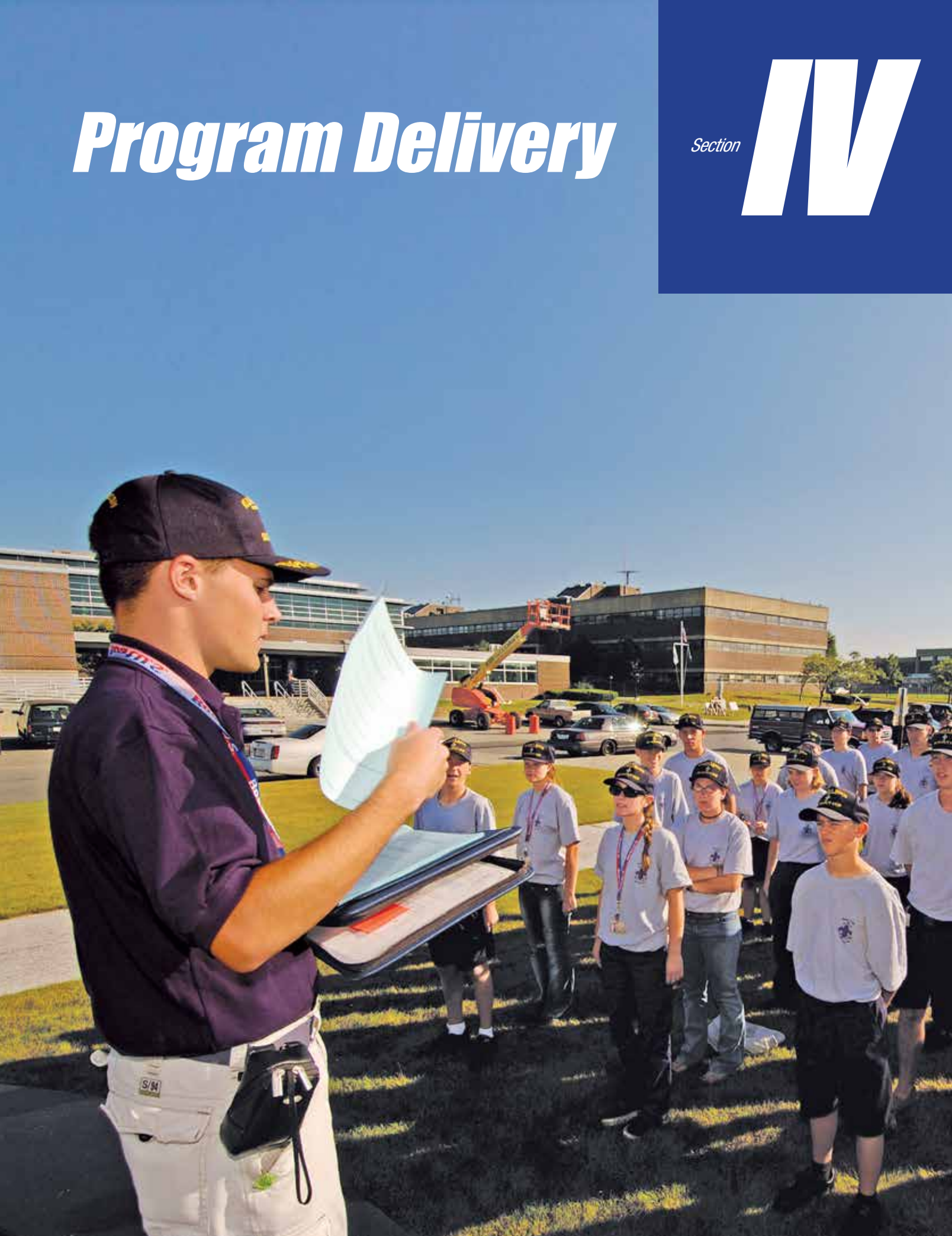



Council Aquatics Committees

Local BSA aquatics programming is enhanced when a council aquatics committee promotes activities, helps procure equipment and instructors, and provides guidance to unit leaders and council professionals. Interested volunteers should check with their local council service center. Some committees have been active for years but need an influx of new members to remain viable. In other councils, the aquatics committee may not exist or may be inactive. In that case, an interested volunteer is needed to work with council professionals to generate sufficient interest to form an active committee. The following material is a guide to aquatics committee organization, responsibilities and activities.

Organization

The aquatics committee has overall responsibility for the local council's aquatics activities in Cub Scouting, Boy Scouting, Venturing, and Exploring. Within the local council organization, the aquatics committee reports to the vice president of program or to the vice president of health and safety. The aquatics committee may be a separate committee or a subcommittee within the camping or health and safety committees.

Members of the aquatics committee should be experienced Scouters with a background in aquatics, or aquatics specialists interested in becoming involved in Scouting. The committee should include at least one individual with a current National Camping School BSA Aquatics Instructor training card.

Besides swimming and water-rescue specialists, the committee should include specialists for the type of aquatics activities prevalent in the local council (e.g., snorkeling/scuba, canoe tripping, sailing, whitewater, crew rowing, waterskiing, Sea Scouting, etc.). Select committee members should be members of or liaisons to other council committees that touch the aquatics committee's areas of responsibility including training, advancement, health and safety, camping, etc.

Camp aquatics directors hired by the council for the summer should be ex officio members of the committee during their term of employment and afterward encouraged to become full-time, year-round volunteer members.

Responsibilities

The aquatics committee's main responsibilities include the following year-round activities tailored to the local council's aquatics activities and opportunities:

- **Training.** Work with the council training committee to provide aquatics training for adults and youth.
- **Program.** Provide and promote a broad array of basic and high-adventure swimming and boating activities to support all parts of the Scouting program.
- **Advancement.** Provide advancement opportunities for youth.
- **Safety.** Actively assess safe operation of council- and district-led aquatics activities including summer camp and promote aquatics safety at the unit level.

- **Attraction, Development, and Retention of Aquatics Leadership.** A primary role of the committee is attracting, developing, and retaining qualified aquatics leaders for the training, program, advancement, and safety activities above. This includes summer camp and year-round council- and district-led aquatics activities and should include succession planning for key roles.

Key Activities

Local council aquatics committee activities should include but are not limited to the following items, grouped by the responsibilities listed above.

Training

- Safe Swim Defense and Safety Afloat
- Basic swimming and boating skills training for unit leaders
- Basic water-rescue skills training for unit leaders
- Development of unit aquatics activities for unit leaders
- Camp aquatics staff training in:
 - Aquatics skills
 - Effective teaching of aquatics skills
 - Aquatics safety including lifeguarding
- Basic canoeing
- Basic crew rowing
- Basic whitewater
- Nonswimmer instruction

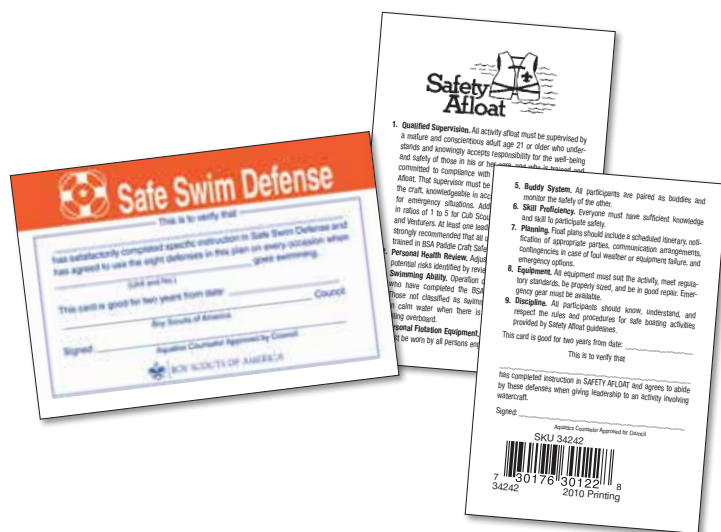

Program

- Promote learn-to-swim programs for all members, especially Cub Scouts, by providing opportunities and incentives.
- Provide or promote whitewater canoe, kayak, rafting trips.
- Provide instruction for special awards: Snorkeling BSA, Kayaking BSA, Boardsailing BSA, Mile Swim BSA.
- Promote aquatics high-adventure opportunities—Northern Tier, Florida Sea Base, other.
- Provide or promote scuba activities.
- Provide enhanced aquatics activities during day camp and resident camp sessions for Cub Scouts and for Boy Scouts.
- Help select, procure, and maintain camp aquatics equipment.
- Provide special aquatics camp sessions for Boy Scouts and Venturers with emphasis on activities not available during regular summer-camp sessions.
- Provide winter swim programs with learn-to-swim and advancement opportunities for Cub Scouts, Boy Scouts, and Venturers.
- Coordinate with other councils to promote programs and resources.
- Implement and promote the aquatics portions of the national Red Cross and BSA agreements and interface with the assigned Red Cross aquatics liaison in the designated local Red Cross chapter.
- Coordinate with other agencies (e.g., YMCA, NAUI, PADI, American Canoe Association, etc.) for joint programs or use of facilities.



Advancement

- Cub Scout electives and Cub Scout Sports award for swimming
- Webelos Aquanaut activity badge
- Second Class and First Class rank requirements
- Swimming and Lifesaving merit badge clinics (non-summer camp)
- Canoeing merit badge (non-summer camp)



Safety

- Promotion of Safe Swim Defense and Safety Afloat at the district and unit level
- Precamp swim classification testing
- Review of council and district safety training and procedures for aquatics activities including day and resident camps
- Inspection of summer camp and other council and district aquatics activities facilities and equipment

Attraction, Development, and Retention of Aquatics Leadership

- Assist with sourcing qualified candidates.
- Assist with interviewing candidates to ensure necessary aquatics experience, training certificates, and aquatics leadership.
- Establish a succession planning process identifying the next aquatics leaders for key roles.
- Establish a program to train, develop, and retain younger aquatics staff members to become aquatics leaders in the future. This includes staff for summer camp and year-round council- and district-led aquatics activities. The staff training process for summer camp staff ideally would begin in the January-to-April period each year to ensure that a well-trained aquatics staff exists before arriving at summer camp.
- Develop and maintain enough qualified instructors, distributed throughout the council, to timely meet all local aquatics training needs.





Appendix

2

Merit Badge Counselors

The following material reviews the BSA merit badge program for aquatics specialists from other organizations interested in volunteering as counselors. Subject-specific information is found in the merit badge pamphlets; counselors should review that information before conducting merit badge sessions.

The Aims of Scouting

The Scouting program is an educational program aimed at teaching youth character development, citizenship, and mental and physical fitness. These aims of Scouting are accomplished through the use of eight fundamental methods:

- The ideals of Scouting (Scout Oath, Scout Law, Scout motto, Scout slogan)
- The patrol method
- The outdoors
- Advancement
- Association with adults
- Personal growth
- Leadership development
- The uniform

What Is Advancement?

Advancement is the process by which a Scout progresses from rank to rank in the Scouting program. It is simply a means to an end and not an end in itself. Everything done to advance and earn higher ranks is designed to help the Scout have an exciting and meaningful experience.

The advancement method is designed to encourage a young man to accomplish a progressive series of fun and educational tasks. Earning merit badges allows Scouts to explore many fields, helps them round out their skills, and perhaps introduces them to subjects that will become lifelong interests or rewarding careers.

What Is a Merit Badge?

A special part of a Scout's learning adventure, merit badges are awards presented to when a Scout has completed the requirements for one of the merit badge subjects. There are more than 100 merit badges a Scout may earn. The subject matters range from vocational and careers introduction to personal development, hobbies, sports, high adventure, citizenship, and life-skills development.

Every merit badge is designed to teach the Scouts new skills while actively encouraging them to challenge themselves and have fun in the process. Merit badges offer a range of difficulty over a breadth of subject matters, and each Scout is free to pursue any merit badge they wish. The merit badge itself is a simple embroidered patch, but the intangible end result of earning it is that the Scout gains self-confidence from overcoming obstacles to achieve a goal.

Why Does the BSA Use Merit Badge Counselors?

One of the methods of Scouting is association with quality adults. Besides a Scout's parents and relatives, school-teachers, religious leaders, and possibly sports coaches, most Scout-age youth do not have much contact with many other adults or professionals. Merit badge counselors provide an excellent means for each Scout to grow through exposure to outstanding adults who serve as examples and mentors to them. The opportunity to deal with business leaders, trained specialists, and experienced hobbyists while pursuing a merit badge offers the Scout a chance for personal growth and possibly a life-altering experience.

The BSA recognizes that the merit badge counselor is the cornerstone to the merit badge program. By offering their time, experience, and knowledge to guide Scouts in one or more merit badge subjects, counselors help shape the future of our country. By assisting as the Scout plans projects and activities necessary to meet the merit badge requirements, and by coaching the Scout through interviews and demonstrations, the quality adult contact fostered by this working relationship can only enhance the Scout's self-confidence and growth.

What Is a Merit Badge Counselor?

A merit badge counselor serves as both a teacher and a mentor as the Scout works on the merit badge. Merit badge counselors should be satisfied that each Scout under their guidance meets all the requirements set forth for the merit badge. In this sense, a merit badge counselor is an examiner. In a larger sense, the real opportunity for a counselor lies in coaching—helping Scouts over the different hurdles of the requirements and helping make them aware of the deeper aspects of the subject from their knowledge and experience.

The merit badge counselor may help a Scout by providing instruction and guidance on the subject matter. However, the counselor must not complete the Scout's work on the requirements. The counselor needs to test the Scout to ensure that all the required work has been completed but **may not modify the merit badge requirements** in the process. This standard ensures that the advancement requirements are fair and uniform for all Scouts.

A merit badge counselor must always ensure that a Scout has a “buddy” present at all instruction sessions. Working on merit badges is especially enjoyable when Scouts work together, and the BSA encourages this by making the buddy system a part of the merit badge program. Together the two meet with merit badge counselors, plan projects, and keep their enthusiasm high. The Scout’s buddy could be another Scout, a parent or guardian, brother or sister, relative, or friend. The Scout should bring a buddy to all appointments with the counselor.

Merit Badge Counselor Requirements and Registration

To qualify as a merit badge counselor, a volunteer must:

- Take Youth Protection training within 30 days of registering.
- Register annually with the Boy Scouts of America.
- Be at least 18 years old.
- Be of good character.
- Be proficient in the merit badge subject by vocation, avocation, or special training.
- Be able to work with Scout-age youth.
- Be approved by the district/council advancement committee.

To register with the Boy Scouts of America, a potential merit badge counselor must complete the BSA’s Adult Application form (No. 524-501; available in Spanish as No. 524-502) and submit it along with the BSA Merit Badge Counselor Information form (No. 34405) to the BSA local council office. Renewal of this registration annually is necessary to continue as a merit badge counselor.

The Boy Scouts of America requires every merit badge counselor to take BSA Youth Protection training before working with youth. This program addresses strategies for personal safety awareness for youth as well as adults. BSA Youth Protection policies include:

- Two-deep leadership
- No one-on-one contact
- Respecting privacy
- Reporting problems

The BSA Youth Protection guidelines have been adopted primarily for the protection of our youth members; however, they also serve to protect our adult volunteers and leaders from false accusations of abuse. BSA Youth Protection training is available online at <https://my.Scouting.org>

The Merit Badge Process

The requirements for each merit badge appear in the current BSA merit badge pamphlet for that award and in the current edition of the *Boy Scout Requirements* book, available at Scout shops and council service centers. When a Scout has decided on a merit badge they would like to earn, they obtain from their Scoutmaster the name and phone number of the district/council-approved merit badge counselor. At this time, the Scoutmaster also can issue the Scout a signed Application for Merit Badge (blue card).

The Scout telephones the merit badge counselor to make an appointment, and together they schedule a date and time for the Scout and buddy to meet. The counselor suggests that the Scout bring the merit badge pamphlet, the Application for Merit Badge, and any work he has started or accomplished, and that he prepare by reading over the requirements.

At their first meeting, the merit badge counselor and the Scout decide upon a tentative schedule for completing the requirements. They should keep the Scout’s other obligations (Scouting, school, worship, etc.) in mind, and set the dates, times, and locations for future meetings. The counselor will explain the requirements for the badge and help the Scout plan ways of fulfilling the requirements while getting the most out of the experience.

Merit badge counselors help Scouts meet the requirements for the merit badge. They may expand on the information in the merit badge pamphlet based on their knowledge, experience, and expertise in the subject. They are encouraged to tell about their own experiences that positively reinforce the subject matter, but new requirements or additional work may not be added. The Scout is expected to meet the requirements for the merit badge as stated—no more and no less.

The number of counseling sessions will depend on the difficulty of the merit badge requirements and the Scout’s preparation and ability. The Scout and counselor are expected to meet as many times as is necessary for the Scout to complete the requirements for the badge. The

advancement program allows the Scout to move ahead in their own way and at their own pace. Rather than competing against others, each Scout commits to a personal challenge of going as far as their ambition will carry them. The rate of advancement depends upon their interest, effort, and ability.

As the Scout completes each requirement, they are always tested (but with a buddy present), and as each requirement is completed, the merit badge counselor marks it on the application. When all the requirements for the merit badge are fulfilled, the merit badge counselor certifies that the Scout has completed the requirements. The Scout may return their completed Application for Merit Badge (blue card, if one is used) to their Scoutmaster.

Counseling Techniques

The most productive environment for the Scout when meeting with the merit badge counselor will be one in which the Scout feels welcome and relaxed. Start the conversation by finding out what the Scout already knows about the subject, then stimulate their interest by showing them something related to it. Be careful not to overwhelm the Scout. (Remember: The Scout is probably a beginner.) Establish an atmosphere that encourages the Scout to ask questions and to ask for help when they need it.

Spend some time helping the Scout learn the requirements, making sure they know they should do exactly what the requirements call for, whether “show” or “demonstrate,” “make,” “list,” “discuss,” “explain,” or “collect, identify, and label.” Take a genuine interest in their projects, and encourage the Scout to complete them.

Remember that the requirements must be completed exactly as presented—do not expand any requirement. However, the Scout may undertake more activities on their own initiative. The merit badge counselor can encourage this without pushing the Scout off course.

Encourage the Scout to practice for their review session and to reflect on their accomplishments. The Scout might approach the review process with some apprehension. The Scout is familiar with final exams in school and may see this meeting with the counselor as another such experience. The counselor can help by talking to the Scout rather than grilling or examining them—there’s a big difference, yet it still will be evident what the Scout knows. Expressing honest enthusiasm for the things the Scout has done will give them confidence.

During testing, the merit badge counselor may find that the Scout needs help learning a particular area. The counselor teaches the needed skill, and then retests to ensure the area has been learned.

Fast Facts for the Merit Badge Counselor

- A merit badge counselor can counsel any Scout, including their own child—although this is discouraged in order to offer a Scout the chance to meet a diverse group of outstanding adults.
- A counselor may be certified in unlimited merit badge subjects, but he or she must be approved for each one.
- There is no limit on the number of merit badges that a counselor may counsel with one Scout. However, the Scout will benefit the most from working with a variety of outstanding adults.
- A merit badge counselor may limit his or her services to one unit but still must be approved by the council advancement committee.
- Scoutmasters and assistant Scoutmasters are not automatically approved as merit badge counselors.
- Group instruction is acceptable, but each Scout must be tested and passed individually.
- There is no time limit for completion of merit badges, but all work on merit badges must be completed before the Scout’s 18th birthday.

Summer Camp Merit Badge Counselors

The same qualifications and rules apply to counselors for council summer camp merit badge programs. All counselors must be 18 years or older, but qualified camp staff members under age 18 may assist the merit badge counselor with instruction. (These assistants are not qualified to sign off on a Scout’s blue card, nor may they certify the Scout’s completion of a merit badge.) As always, each counselor must maintain the exact standards as outlined in the merit badge requirements—nothing deleted, nothing added.

Partial completion of merit badges at summer camp should be credited to a Scout on the Application for Merit Badge (blue card) and given to their Scoutmaster at the end of the week.

Resources for Merit Badge Counselors

ADULT APPLICATION
The volunteer is responsible. The unit leader is responsible.

Your participation in the BSA can help youth become better citizens.

Adult leaders serve an important role models for youth in the BSA and this application aids the chartered organization in selecting qualified adult volunteer leaders.

Youth Protection Training
All adult applicants are required to have this training in order to complete the adult application process. Go to my.scouting.org to create an account and take the training online or contact your local council for classroom training. Include a copy of your completion certificate with this application.

Mission
The mission of the BSA is to prepare young people to make ethical and moral choices over their lifetimes by instilling in them the values of the Scout Oath and Scout Law.

Criminal Background Check*
In order to complete this adult application process, you will need to review the different disclosures that have been separately provided to you. The separate authorization form must be signed and returned when you submit your application.

Excerpt From the Declaration of Religious Principle
The BSA maintains that no member can grow into the best level of citizen without recognizing an obligation to God and, therefore, recognizes the religious element in the training of the member, but it is absolutely nonsectarian in its attitude toward all religions. Its policy is that the home and organization or group with which the member is connected shall give definite attention to religious life. Only persons willing to subscribe to these provisions from the Declaration of Religious Principle and the Bylaws of the BSA, shall be entitled to register.

**The four different background check forms must be torn off and each separately given to the applicant.*

BOY SCOUTS OF AMERICA

This adult registration form consists of a cover sheet, an instruction and information sheet, and a four-part registration form. It is used for all BSA volunteers, including merit badge counselors. Completion of the form is required of all merit badge counselors regardless of whether they are already a registered Scouter, and for each position the volunteer would like to serve in. The form is available online at <http://www.scouting.org/forms>.

Guide to Advancement, No. 33088



This is the handbook for Scouters responsible for advancement at the council, district, and unit levels. It contains the current BSA advancement policies, procedures, rules, and regulations as well as other information.

Application for Merit Badge ("blue card"), No. 34124

APPLICANT'S RECORD		COUNSELOR'S RECORD
The applicant has personally appeared before me and demonstrated to my satisfaction that all requirements have been met for the (please print) _____		Applicant: _____
Name: _____	Unit No. _____	Signature of Scoutmaster: _____
Merit badge: _____	Signature of applicant: _____	Date completed: _____
Address of counselor: _____	Signature of unit leader: _____	Remarks: _____
City: _____	State: _____	
Telephone No. of counselor: _____	Completed on: _____ Date: _____ by _____	
Signature of applicant: _____	Signature of unit leader: _____	
Checked and recorded: _____	Signature of unit leader: _____	
DOB: _____	Signature of unit leader: _____	
Certificate and badge presented: _____	Signature of unit leader: _____	
Applicant will turn in this portion to their unit leader for record-keeping.	NOTE TO SCOUTMASTER, COUNSELOR, OR SEA SCOUT: Retain this copy for your permanent records.	It is suggested that the counselor keep this record in case any question is raised later in regard to this award.

This three-panel, blue wallet-sized card (1) shows that the Scout has permission to start working on a particular merit

badge; (2) records the Scout's progress; and (3), when completed, provides a separate record for the Scout, the counselor, and the unit.

Boy Scout Handbook, No. 34554

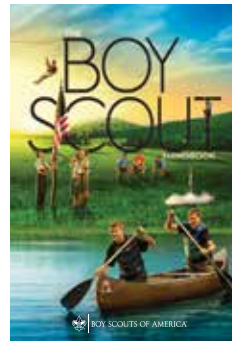

This is the critical document for a Scout, providing the basic information for all facets of Scouting, including a chapter on the merit badge program.

Boy Scout Requirements, No. 33216

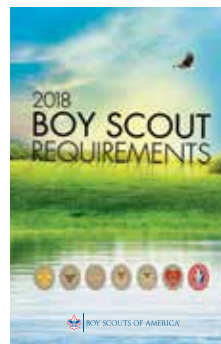

Updated yearly, this book contains the complete, official requirements for all BSA merit badges, ranks, and special awards. Requirements in this publication may be more current than the merit badge pamphlet; therefore, the *Boy Scout Requirements* takes precedence.

A Guide for Merit Badge Counseling, No. 512-065

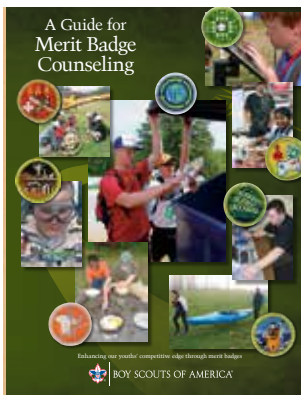

This folder gives potential merit badge counselors an introduction to the advancement program and the merit badge counselor's role. It also lists all the current merit badge subjects.

Merit Badge Pamphlet Series

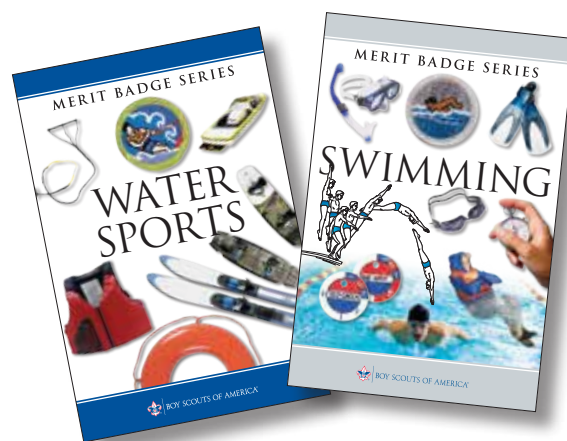

Merit Badge Counselor Information Form, No. 34405

When attached to the Adult Application, this document specifies the merit badge subjects a counselor wants to coach and secures the counselor's agreement to follow the merit badge requirements and BSA policies. This form is available online at <http://www.scouting.org/BoyScouts/GuideforMeritBadgeCounselors/Resources>.

The merit badge pamphlets are written for Scout-age youth. The information presented in the pamphlet will help the counselor understand what the Scout may be studying and the level of learning expected by the Boy Scouts of America. The pamphlets may also contain suggestions for projects or demonstrations required to earn the merit badge. At times, the requirements presented in the merit badge pamphlet may not match those in the current edition of the *Boy Scout Requirements* book. The *Boy Scout Requirements* criteria take precedence. Once a Scout has started working on a merit badge, they may stay with the requirements that were in effect when they started. The Scout is not required to meet newly introduced changes unless the national office places a specific timeline on the implementation of new requirements.

Troop Leader Guidebook, Volumes 1 and 2 (33009 and 33010)

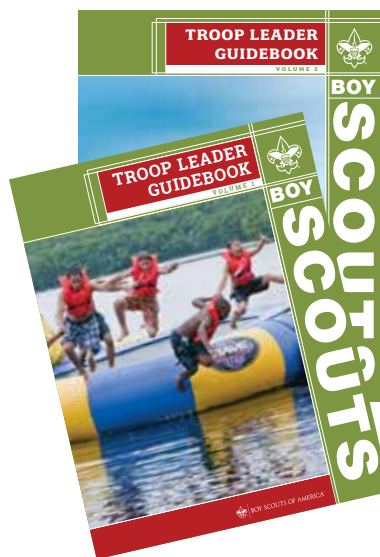

As the troop leader's primary guide, the two-volume *Troop Leader Guidebook* contains sections on advancement that include advice on recruiting counselors and other advancement resources.



Requirements and Application Forms

This text serves as the manual for the BSA Aquatics Supervision: Swimming and Water Rescue and Paddle Craft Safety programs. It also serves as a primary resource for the Mile Swim BSA, Snorkeling BSA, Kayaking BSA, and Boardsailing BSA recognitions. The requirements for each of those recognitions follow. Anyone interested in earning those recognitions should check with the local council for qualified instructors. Anyone interested in serving as an instructor needs to check with the council for the qualification procedure and additional support material.

Requirements for Scuba BSA are also given here, but both the participant and the instructor need to review the additional material found in the *Scuba BSA* brochure, No. 430-515.

Requirements for the aquatics merit badges are found in the individual merit badge pamphlets and are summarized in the *Boy Scout Requirements* book.

Kayaking BSA Application



Name of applicant _____

Address _____

City _____ State _____ Zip _____

Unit type _____ Unit number _____ Council _____

Name of council-approved counselor _____

Address _____

City _____ State _____ Zip _____

Counselor qualification _____

Signature of counselor signifies applicant has completed all requirements: _____ Date _____

Requirements

1. Before fulfilling the following requirements, successfully complete the BSA swimmer test.
2. Do the following:
 - a. Describe various types of kayaks and how they differ in design, materials, and purpose.
 - b. Name the parts of the kayak you are using for this exercise.
 - c. Demonstrate how to choose an appropriately sized kayak paddle and how to position your hands.
3. Do the following:
 - a. Tell what precautions must be taken for a safe trip afloat.
 - b. Demonstrate how to select and properly fit a life jacket.
 - c. Explain the importance of safety equipment such as life jackets, air bags, grab loops, and helmets.
4. Demonstrate your ability to aid yourself and others in the event of a capsized:
 - a. Capsize your kayak in water at least seven feet deep, perform a wet exit if necessary, and swim the boat to shore.
 - b. With assistance, if needed, ready the capsized craft for use.
 - c. Show how to approach a capsized paddler in your kayak and tow him to shore.
 - d. While upright in your kayak, right a capsized kayak, empty it of water, and assist the paddler aboard without returning to shore.
5. As a solo paddler, demonstrate the following:
 - a. Entering and launching a kayak from shore or dock
 - b. Landing or docking and exiting a kayak
 - c. Forward stroke
 - d. Sweep stroke
 - e. Reverse sweep
 - f. Draw stroke
 - g. Rudder stroke
 - h. Back stroke
6. As a solo paddler, do the following:
 - a. Paddle forward in a reasonably straight line.
 - b. Move the kayak sideways to the right and to the left.
 - c. Pivot 360 degrees to the right and left.
 - d. Stop the kayak.

Notes to Counselor:

Any youth or adult who is registered with a troop, crew, or ship and completes the requirements is eligible for a patch and recognition card, available from the local council service center. The completed award application should be handled as directed by the council Training, Aquatics, or other committee. Instruction for Kayaking BSA is to be conducted under safe conditions on calm water. Two to four hours in one or more sessions should suffice for instruction and practice. Paddle lengths and life jacket sizes should be adequate to fit all participants. Feathered blades are preferred, but blades at the same angle are allowed. Information and skills are discussed in *Aquatics Supervision: A Leader's Guide to Youth Swimming and Boating Activities*, No. 34346, and the Kayaking merit badge pamphlet. All counselors must be trained in Safety Afloat. Any

person with current training as a BSA Aquatics Instructor, a BSA Aquatics Supervision: Paddle Craft Safety kayak instructor or as a kayak instructor by the American Canoe Association may serve as a counselor for this award with the approval of the local council. A person with similar experience in kayaking skills, safety, and instruction may also serve as a counselor with council approval. Kayaking BSA is intended to provide Scouts and their leaders with an introductory experience to kayaking on lakes, ponds, slow-moving water, or calm ocean areas. Additional preparation is needed before a unit does extended kayak touring or takes trips on class I or above white water.

Snorkeling BSA Application



Name of applicant _____

Address _____

City _____ State _____ Zip _____

Unit type _____ Unit number _____ Council _____

Name of council-approved counselor _____

Address _____

City _____ State _____ Zip _____

Counselor qualification _____

Signature of counselor signifies applicant has completed all requirements: _____ Date _____

Requirements

- Before doing other requirements, successfully complete the BSA swimmer test: Jump feetfirst into water over the head in depth, level off, and begin swimming. Swim 75 yards in a strong manner using one or more of the following strokes: sidestroke, breaststroke, trudgen, or crawl; then swim 25 yards using an easy, resting backstroke. The 100 yards must be completed in one swim without stops and must include at least one sharp turn. After completing the swim, rest by floating.
- Discuss the importance of using the buddy system at all times while snorkeling and list duties of a buddy, beginning with equipment checks.
- Explain the function, fit, and selection of mask, fins, and snorkel. Discuss the use of inflatable flotation vests and life jackets when snorkeling in open water.
- In confined, shallow water (about waist deep), demonstrate use of mask and snorkel:
 - Show how to prevent the mask from fogging and how to equalize pressure in mask, ears, and sinus cavities. With your head underwater, flood the mask, observe the effect on your vision, surface, and drain the water from the mask.
 - With your face in the water, breathe through the snorkel. Then submerge, surface, clear water from the snorkel, and resume free breathing without removing the snorkel from your mouth.
- In confined, shallow water, demonstrate the use of swim fins: Do first using only fins, and then repeat with a mask and snorkel.
 - Fit and adjust fins to feet.
 - Walk with fins as if entering from a beach.
 - Swim at the surface (10 yards) and underwater (three yards) using the flutter kick.
 - Control direction without using hands while swimming with fins at the surface and underwater.
- In confined, deep water (six to 12 feet), demonstrate:
 - Proper techniques for entering and exiting the water with snorkeling equipment from a dock or boat.
 - Headfirst and feetfirst surface dives, including proper body position for safe ascent and descent.
- Show knowledge of snorkeling signals:
 - Demonstrate divers' signs and signals, both audible and visual, for use at the surface and underwater.
 - Set out a diver down flag and explain its function.
- In clear, confined water eight to 12 feet deep that has a firm bottom, while swimming with a buddy, use mask, fins, and snorkel to locate and recover an object from the bottom.
- Demonstrate basic survival skills:
 - Float facedown for five minutes while breathing through a snorkel with a minimum of movement.
 - Demonstrate survival floating for five minutes without use of a snorkel.
 - Using fins, show how to tow an exhausted or unconscious buddy to safety.
- Review and explain the eight points of Safe Swim Defense and BSA Snorkeling Safety. Explain training, preparations, and precautions required for snorkeling in open water. Explain environmental factors that affect snorkeling and discuss special precautions needed for oceans, streams, and lakes.
- Explain pressure, buoyancy, and submerged optics and acoustics related to snorkel swimming and diving.
- Discuss the effects of submersion on the body and how to handle potentially dangerous situations:
 - What is hyperventilation and how is it avoided?
 - What are the symptoms and consequences of hypothermia?
 - Why is CPR training recommended for those participating in swimming and snorkeling activities?

(See Notes to Counselor on next page.)

Snorkeling BSA: Notes to Counselor

The Snorkeling BSA requirements introduce the special skills, equipment, and safety precautions associated with snorkeling; encourage the development of aquatics skills that promote fitness and recreation; and provide a foundation for those who later will participate in more advanced underwater activity.

Any youth or adult who is registered with a troop, crew, or ship and completes the requirements is eligible for a patch and recognition card. The completed award application should be handled as directed by the council Training, Aquatics, or other committee.

All counselors must have current Safe Swim Defense training and council approval. Anyone currently trained as a BSA Aquatics Instructor or certified as a snorkeling instructor by a BSA recognized scuba training agency may serve as a counselor for the Snorkeling BSA award. Councils may also approve counselors who have been trained and are supervised by those with the previously listed credentials.

Instruction must be conducted in clear, confined water with a maximum depth of 12 feet. A swimming pool is recommended. Snorkeling BSA is ideally suited to winter programs using indoor pools. Three 45-minute sessions are recommended for instruction, practice, and completion of requirements.

All aspects of Safe Swim Defense apply during instruction, practice, and all other snorkeling activities. Snorkeling in open water requires each participant to first demonstrate knowledge and skills equivalent to the Snorkeling BSA requirements.

Aquatics Supervision: A Leader's Guide to Youth Swimming and Boating Activities, No. 34346, provides reference material for Snorkeling BSA instruction. Scuba training agencies, equipment manufacturers, and others occasionally publish references available online and through bookstores and dive shops. Although few dedicated snorkeling texts are available, instruction manuals for scuba diving contain pertinent information.

All requirements must be completed as stated on the application form. The counselor may not omit, vary, or add requirements. The skill requirements are listed in an order appropriate for instruction.

The second requirement considers the time-honored and time-proven principle of the buddy system. Snorkelers must use the buddy system at all times. Before beginning the activity, each person helps their buddy fit and check equipment. The principle of the buddy system is that two people can enjoy an aquatics activity together while each provides a critical margin of safety for the other. Each buddy must constantly be aware of the condition and circumstances of their buddy, and must always be prepared to call for aid or give immediate assistance if needed.

Scuba BSA Application



Name of applicant _____

Address _____

City _____ State _____ Zip _____

Unit type _____ Unit number _____ Council _____

Name of council-approved counselor* _____

Address _____

City _____ State _____ Zip _____

Agency qualification and scuba instructor number* _____

Signature of counselor signifies applicant has completed all requirements: _____ Date _____

**The counselor must hold an instructor rating with current teaching status with PADI, NAUI, SSI, or RSTC member organization in accordance with BSA scuba policies in the Guide to Safe Scouting. Counselors must have council approval.*

Requirements

1. Before doing other requirements, successfully complete the BSA swimmer test. To begin the test, jump feetfirst into water over the head in depth, level off, and begin swimming. Swim 75 yards in a strong manner using one or more of the following strokes: sidestroke, breaststroke, trudgen, or crawl; then swim 25 yards using an easy, resting backstroke. The 100 yards must be completed in one swim without stops and must include at least one sharp turn. After completing the swim, rest by floating.
 2. Discuss the importance of using the buddy system at all times while scuba diving. Explain that a dive buddy is there to assist with the donning and doffing of equipment, to lend assistance in case of emergency, and to share in the underwater experience. Remember, always dive with a buddy—**Never dive alone!**
 3. Review hazards associated with scuba diving, including causes of decompression incidents, and safety procedures to avoid them. Explain the importance of never using scuba equipment unless you are enrolled in a training exercise or have completed a diver certification program taught by a certified instructor.
 4. State the purpose of the following pieces of basic diving equipment: mask, fins, BCD, BCD inflator, regulator, air gauge, and alternate air source.
 5. Describe how to locate the air gauge, and explain how to recognize the “caution zone” on it.
 6. Don and adjust mask, fins, snorkel, BCD, scuba, and weights with the assistance of a buddy, an instructor, or a certified assistant.
 7. While underwater, demonstrate and recognize the following hand signals: OK?/OK!; Stop; Up; Down; Out of air; Come here; Ears not clearing; Slow down/ Take it easy; Something is wrong; Watch me; Check your air supply.
 8. Inflate/deflate a BCD at the surface using the low-pressure inflator.
 9. In shallow water, demonstrate proper compressed air breathing habits; remember to breathe naturally and not hold the breath.
 10. Clear the regulator while underwater using both exhalation and purge-button methods, and resume normal breathing from it.
 11. In shallow water, recover a regulator hose from behind the shoulder while underwater.
 12. In shallow water, clear a partially flooded mask while underwater.
 13. Swim underwater with scuba equipment while maintaining control of both direction and depth, properly equalizing the ears and mask to accommodate depth changes.
 14. While underwater, locate and read submersible pressure gauge and signal whether the air supply is adequate or low based on the gauge’s caution zone.
 15. Describe how to avoid hazardous aquatic life (if applicable to your confined water location).
- (See Notes to Counselor on next page.)**

Scuba BSA: Notes to Counselor

All aspects of the Scuba BSA program must conform with the BSA scuba policy found in the *Guide to Safe Scouting*. Instructors not familiar with the Scouting program should consult the BSA manual, *Aquatics Supervision: A Leader's Guide to Youth Swimming and Boating Activities*, No. 34346, which also contains the BSA scuba policy.

Counselors for Scuba BSA must hold current scuba instructor certification from PADI, NAUI, SSI, or RSTC member organizations. Instruction must comply with RSTC standards for introductory scuba experiences. Minimum standards include instructor-to-participant ratios. In a pool, the maximum ratio is eight participants per instructor. In a confined waterfront setting, the maximum ratio is four participants per instructor. Ratios may be increased by two participants if the instructor is assisted by someone certified as a divemaster or assistant instructor.

A second adult who understands the procedures should be present in case the instructor becomes incapacitated. Two-deep adult leadership is also required by BSA Youth Protection guidelines.

Before participants are allowed in the water, they must complete an Annual Health and Medical Record designed for scuba activities. Instructors should use standard forms advocated by their certifying agency.

Instructors may use agency materials, such as participant guidebooks, slide shows, and videos to help convey cognitive material. Skill instruction must be conducted in clear, confined water. A swimming pool is recommended.

Scuba BSA is ideally suited to winter programs using indoor pools. Two 45-minute sessions are appropriate for instruction, practice, and completion of requirements.

Although Scuba BSA is similar to introductory scuba experiences offered by various RSTC member organizations and other dive agencies, those programs are not substitutes for Scuba BSA. All requirements must be completed as stated on the application form. The counselor may not omit, vary, or add requirements. In particular, Scuba BSA has a prerequisite swimming requirement, is only available to youth and adults registered in the Boy Scout, Venturing, or Sea Scout programs (minimum age around 10½), and does not include the option of an open-water dive.

Local council programs may not compress or sell air for scuba use, or sell, rent, or loan scuba equipment. All air and equipment for local council Scuba BSA programs must be obtained from properly licensed sources, not affiliated with the Boy Scouts of America and under the supervision of PADI, NAUI, SSI, or RSTC-approved and certified scuba instructors.

Individuals completing the Scuba BSA requirements qualify for a recognition card and patch. The completed award application should be handled as directed by the council Training, Aquatics, or other committee.



The Scuba BSA program was created and implemented with assistance from International PADI Inc., www.padi.com.

Mile Swim BSA Application



Name of applicant _____

Address _____

City _____ State _____ Zip _____

Unit type _____ Unit number _____ Council _____

Name of council-approved counselor _____

Address _____

City _____ State _____ Zip _____

Counselor qualification _____

Signature of counselor signifies
applicant has completed all requirements: _____ Date _____

Requirements

1. Explain how regular exercise contributes to good health and why swimming is one of the best forms of exercise.
2. Tell what precautions and procedures a swimmer and escort must follow for distance swimming over open water.
3. Under the supervision of a currently qualified counselor, participate in four hours of training and preparation for distance swimming (one hour a day maximum).
4. Swim one mile over a measured course that has been approved by the counselor supervising the swim.

How Important Is Exercise?

Regular exercise is an important contributor to a long and healthy life. For example, exercise lowers several risk factors for heart disease. People who exercise regularly are much less likely to be overweight. Not only does exercise burn calories, it may actually suppress appetite. Blood pressure is reduced by exercise. The combination of exercise and weight reduction often allows people with hypertension to control their blood pressure without the use of medication. Smokers commonly discontinue that habit as they begin exercise programs. Active joggers tend to have lower total cholesterol than those who do not run. When it comes to protecting your heart, there is no substitute for exercise.

Without sufficient exercise, bones become demineralized. They lose calcium and become brittle. Demineralization can progress rapidly in those who are bedridden and cannot exercise. Demineralization is a concern for astronauts since lack of gravity robs activity of its exercise value. Weak and brittle bones, caused by lack of exercise, are common in senior adults.

Exercise is an excellent cardiovascular conditioner and important to living better as well as longer. People who exercise regularly feel and look younger than those who do not. Improvements in muscle tone and circulation undoubtedly contribute to freedom from fatigue and the feeling of well-being that the physically fit enjoy.

Swimming is to some degree superior to other forms of exercise because it is a full-body exercise (all muscles and joints are exercised) and because it avoids the risk of damage to joints and other parts of the body that may result from activity such as running. The extensive use of swimming therapy for the injured and impaired is further evidence of its value as a body conditioner.

(See Notes to Counselor on next page.)

Mile Swim BSA: Notes to Counselor

The Mile Swim BSA recognition provides a sense of accomplishment and supports confidence, safety, skill, and physical fitness. The ability to swim long distances in warm water in time of need provides a margin of safety for all aquatics activities. Swimming skills and physical stamina are also needed to assist others. In addition to safety, Mile Swim BSA should encourage the development of physical fitness by introducing youth to swimming as regular exercise. However, it is not a competitive training program limited to specific strokes that emphasize speed over efficiency. Swimming skills, including mastery of restful strokes, are as important to the program as endurance. Anyone who can walk a mile without stopping should have sufficient stamina to swim a mile with restful strokes. Just as walking is a viable exercise alternative to jogging or sprinting, restful swimming strokes used over long distances in place of a fast crawl can also play a positive role in physical conditioning.

Counselors for Mile Swim BSA must be approved by the council. Adults trained as a BSA Aquatics Instructor, a Red Cross Water Safety Instructor, or a YMCA Swim Instructor are good candidates. Swim coaches with a Scouting background are also appropriate. All counselors must have current Safe Swim Defense training.

All in-water exercises must conform to Safe Swim Defense guidelines. The requirements specify that the participant first prepare before swimming a continuous mile. Four sessions of an hour each are appropriate. Each session should include a discussion of objectives, warm-up, stroke tips, and swims for increased distances. Short sprints may be included to illustrate different levels of aerobic exercise. The groundwork sessions are intended to ensure the success of all applicants who begin with reasonable swimming skills. The goal is encouragement and skill refinement, not elimination. Virtually all of those who participate in the training should be able to complete the mile, particularly if they are shown how to refine the

crawl stroke using rhythmic breathing with the head in the water and to use alternative restful strokes such as the elementary backstroke, the breaststroke, and the sidestroke that utilize a relaxed pace and a glide.

The training sessions may be conducted separately or in combination with another program, such as instruction for the *Swimming* merit badge. Credit may be given anyone, such as a swim-team member, who provides evidence of regular participation in a supervised swim training or fitness program that covers at least four hours over four different, regularly scheduled sessions.

The continuous mile may be done using any combination of strokes and has no time limit. The swimmer may pause in deep water either by floating or treading water but may not rest by standing or holding to the side. Both open and flip turns are allowed in pools.

The mile may be covered by laps in a pool or at an enclosed waterfront swimming area.

Courses over extended distances in open water must conform to Safe Swim Defense guidelines regarding hazards such as submerged trees, currents, or boat traffic, as well as water quality, depth, and clarity.

Each individual swimmer, or at most a buddy pair, may be accompanied by a rowboat with two people onboard, one skilled in controlling the boat and the other trained in basic water rescue, equipped with a reaching device and a flotation aid, continuously watching the swimmer(s). The swimmer, not the boat, must set the pace.

Alternatively, a closed circuit may be established where all swimmers are constantly in reach of safety personnel strategically positioned at fixed points on anchored boats, the shore, or piers. Each participant swims with a buddy, and the number and spacing of those in the water should not exceed the capacity of the watchers to easily count the swimmers as they move from one zone to another.

BSA Stand Up Paddleboarding Application



Name of applicant _____

Address _____

City _____ State _____ Zip _____

Unit type _____ Unit number _____ Council _____

Name of council-approved counselor _____

Address _____

City _____ State _____ Zip _____

Counselor qualification _____

Signature of counselor signifies applicant has completed all requirements: _____ Date _____

Requirements

1. Review the BSA Safety Afloat policy. Explain to your instructor how this applies to stand up paddleboarding.
2. Before fulfilling other requirements, successfully complete the BSA swimmer test: Jump feetfirst into water over the head in depth, level off, and begin swimming. Swim 75 yards in a strong manner using one or more of the following strokes: sidestroke, breaststroke, trudgen, or crawl; then swim 25 yards using an easy, resting backstroke. The 100 yards must be completed in one swim without stops and must include one sharp turn. After completing the swim, rest by floating.
3. Explain safety considerations for stand up paddleboarding in the following environments: lake, moving water, white water, open ocean, ocean surf.
4. Review the characteristics of life jackets most appropriate for stand up paddleboarding and understand why one must always be worn while paddling. Then demonstrate how to select and fit a lifejacket for stand up paddleboarding.
5. Describe the correct type of leash to wear in the appropriate water venues.
6. Name and point out:
 - a. The major parts of a stand up paddleboard
 - b. The parts of a paddle for stand up paddleboarding
7. Discuss:
 - a. The different types of stand up paddleboards
 - b. How to correctly size and hold a paddle for stand up paddleboarding
8. Using a properly outfitted stand up paddleboard, demonstrate the following:
 - a. How to safely carry a stand up paddleboard
 - b. How to safely paddle away from a dock or shoreline (on knees)
 - c. How to stand and balance on a board in the neutral position
 - d. How to appropriately fall off a board
 - e. How to remount the board
 - f. Forward stroke
 - g. Back stroke
 - h. Forward sweep
 - i. Reverse sweep
 - j. Draw stroke
 - k. One self-rescue technique—lay on your stomach and paddle with your hands
9. With *supervision* from your instructor, paddle a course that involves:
 - a. A straight line for 25 yards and stop within one board length
 - b. A figure 8
 - c. Moving abeam to the right 10 feet and to the left 10 feet

Notes to Counselor

Any youth or adult who is registered with a troop, crew, or ship and completes the requirements is eligible for a patch and recognition card. The completed award application should be handled as directed by the council Training, Aquatics, or other committee. Instruction for the BSA SUP award is to be conducted under safe conditions on calm water. One to three hours in one or more sessions should suffice for instruction and practice.

Information and skills are discussed in *Aquatics Supervision: A Leader's Guide to Youth Swimming and Boating Activities*, No. 34346, and the BSA SUP brochure at www.scouting.org. All counselors must be trained in Safety Afloat and have council approval. Any person with current training as a BSA Aquatics Instructor or as a SUP instructor by the American Canoe Association, or a person with similar experience in SUP skills, safety, and instruction may serve as a counselor.

Boardsailing BSA Application



Name of applicant _____

Address _____

City _____ State _____ Zip _____

Unit type _____ Unit number _____ Council _____

Name of council-approved counselor* _____

Address _____

City _____ State _____ Zip _____

Counselor qualification _____

Signature of counselor signifies
applicant has completed all requirements: _____ Date _____

Requirements

1. Before fulfilling the following requirements, you must successfully complete the BSA swimmer classification test.
2. Review how each point of BSA Safety Afloat applies to boardsailing.
3. Explain precautions for the following environmental factors: dying wind, high wind, offshore winds, currents, waves, and lightning.
4. Discuss the prevention, recognition, and treatment of the following health concerns that could arise while boardsailing: hypothermia, sunburn, dehydration, and heat exhaustion.
5. Properly rig and prepare the sailboard you are using. Identify each of the following: uphaul, outhaul, downhaul, cleat, leach, tack, clew, foot, luff, skeg, centerboard, wishbone boom, and universal. Explain luffing. Explain how to steer the sailboard by adjusting the center of effort.
6. Demonstrate your ability to uphaul the sail, find the neutral position to the wind (sail luffing), and control the board's position with foot movement.
7. With supervision from your instructor, sail a course that involves beating, reaching, and running. Change direction by tacking into the wind.

Notes to Counselor

Boardsailing BSA has been developed to introduce basic boardsailing skills, equipment, and safety precautions; to encourage the development of skills that promote fitness and safe aquatic recreation; and to lay a foundation for more advanced and demanding boardsailing activities. Any youth or adult who is registered with a troop, crew, or ship and completes the requirements is eligible for a patch and recognition card. The completed award application should be handled as directed by the council Training, Aquatics, or other committee.

All counselors must be trained in Safety Afloat and have council approval. Any person recognized as a boardsailing instructor by US Windsurfing or US Sailing, or someone with similar experience in boardsailing skills, safety, and instruction, may serve as a counselor for this award.

Instruction must be conducted on a protected body of water in an area free from other traffic or large waves. Initial water entry and practice should be on a gradual beach clear of hazards. A steady three-to-seven knot breeze is ideal for beginner practice. All participants should be close enough to supervisory personnel for efficient instruction and ready assistance.

All requirements must be completed as stated. Basic skills and safety precautions are presented in the BSA publication: *Aquatics Supervision: A Youth Leader's Guide for Swimming and Boating Activities*, No. 34346. Additional resources may be found online at www.uswindsurfing.org and www.ussailing.org.

Whitewater Rafting BSA Application



Name of applicant _____

Address _____

City _____ State _____ Zip _____

Unit type _____ Unit number _____ Council _____

Name of council-approved counselor _____

Address _____

City _____ State _____ Zip _____

Counselor qualification _____

Signature of counselor signifies
applicant has completed all requirements: _____ Date _____

Requirements

1. Before doing the following requirements, successfully complete the BSA swimmers test.
2. Do the following:
 - a. Name the parts of a whitewater raft.
 - b. Describe differences between a paddle raft and an oar-powered raft.
 - c. Explain the importance of perimeter lines used on whitewater rafts.
 - d. Demonstrate how to choose an appropriate size paddle.
 - e. Demonstrate how to select and properly fit a life jacket.
 - f. Demonstrate how to select and properly fit a helmet.
 - g. Discuss the use of throw ropes in rescuing overboard paddlers.
 - h. Discuss common river hazards including rocks, strainers, broaching, standing waves, hydraulics, and foot entrapment.
3. Explain the importance of safety equipment used in whitewater rafting including throw ropes, helmets, and life jackets. Also discuss appropriate clothing and footwear for a whitewater rafting trip.
4. Under proper supervision and appropriate conditions safely do the following:
 - a. Lift, carry, launch, and land an inflatable raft, with help, on calm or slow-moving water.
 - b. Sit in a raft as a paddler with proper foot position.
 - c. Swim a Class I rapid while wearing a life jacket, helmet and attire appropriate for the water temperature. Demonstrate defensive and aggressive swimming positions as possible.
 - d. Re-enter a raft from the water, with assistance if needed.
5. While on calm or slow-moving water, demonstrate the following strokes in an inflatable raft with at least one other paddler and on command of a qualified paddle captain:
 - a. Forward
 - b. Back
6. While on moving water up to Class I, demonstrate the following maneuvers with at least three other paddlers in an inflatable raft and on the command of a qualified paddle raft captain:
 - a. Turn left.
 - b. Turn right.
 - c. Paddle forward in a straight line for 50 feet.
 - d. Back paddle reasonably straight for 15 feet.
7. While on moving water up to Class I, demonstrate the following maneuvers with at least three other paddlers in an inflatable raft and on the command of a qualified paddle raft captain:
 - a. A front or a back ferry.
 - b. A shallow or a wide eddy turn.
 - c. A shallow or a wide peel out.
8. Participate in a whitewater rafting trip in up to Class III white water with a qualified paddle raft captain in each raft using a minimum of two rafts and for at least one hour's duration.

(See Notes to Counselor on next page.)

Notes to Counselor

This award is available to BSA youth and adults who are members of Boy Scout, Venturing, or Sea Scout units. Any adult leader, approved by the council, who is trained in Safety Afloat and can personally verify that all instruction and skill completions were directly supervised by a professionally

trained or licensed rafting guide may serve as a counselor for this award. Such guides may be employed by council high-adventure programs or commercial outfitters. Guidance for selecting a reputable rafting service is provided in the BSA publication *Aquatics Supervision*, No. 34346.

BSA Aquatics Supervision: Swimming and Water Rescue

Purpose

Training for Aquatics Supervision: Swimming and Water Rescue provides BSA leaders with information and skills to prevent, recognize, and respond to swimming emergencies during unit swimming activities. It expands the awareness instruction provided by Safe Swim Defense training. Persons completing the training should be better able to assess their preparation to supervise unit swimming events. The BSA recommends that at least one person with this training is present to assist with supervision whenever a unit swims at a location that does not provide lifeguards. This training is open to any registered adult leader, Scout, Venturer, or Explorer who is age 15 or older. A council-approved instructor must directly supervise all training. The course takes approximately eight hours and is valid for three years. An instructor guide is found at www.scouting.org/filestore/Outdoor%20Program/Aquatics/pdf/430-505.pdf.

Although the training is consistent with training provided professional lifeguards, the Swimming and Water Rescue course is not a lifeguard training course and is not a substitute for BSA Lifeguard training for summer camp aquatics staff. On the other hand, this course addresses important information that may not be covered in generic lifeguard training programs such as: preventative measures, including the buddy system and swim classification tests; how to set up a safe swim area in diverse situations; the use of non-standard rescue equipment; and emergency action plans in remote settings. Therefore, BSA leaders with lifeguard training from other agencies are encouraged to complete this course prior to supervising unit swim activities in remote settings. A “challenge” option is provided to foster cross-training of individuals with training from other agencies.

Adult and youth first aid training, including CPR, is an important safety consideration for all Scouting activities, not just swimming. First aid training is not included in the Swimming and Water Rescue course with the expectation the leader has addressed this need separately, as noted in the course material and on the training card.

Prerequisites

- 1. Age, physical fitness, and training:**
 - A. Be 15 years old or older prior to training.
 - B. Submit written evidence of physical fitness.
 - C. Complete Safe Swim Defense training.
- 2. Swimming ability:**
 - A. Complete the BSA swimmer test: Jump feetfirst into water over the head in depth. Level off and swim 75 yards in a strong manner using one or more of the following strokes: sidestroke, breast stroke, trudgen, or crawl; then swim 25 yards using an easy, resting backstroke. The 100 yards must be completed in one swim without stops and must include at least one sharp turn. After completing the swim, rest by floating.
 - B. Recover a 10-pound weight from 8 feet of water.

Requirements

3. Administer **both** the BSA beginner and swimmer classification tests.
4. Demonstrate reaching assists from deck, side, and shallow water using items such as arms, legs, towels, rescue tubes, and poles.
5. Twice demonstrate throwing assists using items such as lines, ring buoys, throw bags, and free-floating supports. Successfully place at least one such aid within reach of a subject 25 feet from shore.
6. Demonstrate stride jump and compact jump entries into deep water.
7. Demonstrate an accompanied rescue for a conscious subject in deep water 20 feet from shore. Enter the water with a buoyant aid, present the aid to the subject, release it, and accompany the subject to shore. Speak to the subject throughout the assist to provide clear instruction and encouragement.
8. Demonstrate a contact rescue for an unconscious subject at or near the surface in deep water 20 feet from shore:
 - A. Approaching the subject from the front, use a wrist tow to move the subject to shore. During the approach, confirm that the subject is passive.
 - B. Approaching the subject from the rear, use an armpit tow to move the subject to shore. During the approach, confirm that the subject is passive.
 - C. With the assistance of one other person, and without the aid of a backboard, remove an unconscious subject from the water at the edge of the pool or pier and check for breathing and circulation.
9. Practice in-water rescues of both conscious and unconscious subjects using a variety of flotation aids.
10. Demonstrate the following defensive actions:
 - A. Front head-hold escape
 - B. Rear head-hold escape
11. Demonstrate a line-and-tender rescue as both the swimmer and the line tender.
12. Demonstrate in-line stabilization for a suspected spinal injury in shallow water:
 - A. For a faceup subject
 - B. For a facedown subject
13. Correctly answer 80 percent of the questions on the Swimming and Water Rescue written exam covering Safe Swim Defense, emergency action plans, surveillance, victim recognition, and water rescue. Review any incomplete or incorrect answers.

BSA Aquatics Supervision: Paddle Craft Safety—Basic

Purpose

Float trips are popular Boy Scout and Venturing activities. Safety Afloat awareness training provides guidelines for safe float trips and is required of unit leaders, but does not provide the skill training mandated by those guidelines. Aquatics Supervision: Paddle Craft Safety—Basic expands Safety Afloat training to include the skills, as well as the knowledge, needed for a unit leader to confidently supervise canoeing or kayaking excursions on flat water. Persons completing the training should be better able to access their preparation to supervise paddle craft activities. The training is open to any registered adult leader, Scout, Venturer, or Explorer who is age 15 or older. The training must be conducted by a council-approved instructor, takes roughly eight hours, and is valid for three years. An Instructor Guide is available at: www.scouting.org/filestore/Outdoor%20Program/Aquatics/pdf/430-501.pdf.

Adult and youth first aid training, including CPR, is an important safety consideration for all Scouting activities, not just boating. First aid training is not included in the Paddle Craft Safety course with the expectation that the leader has addressed that need separately, as noted in the course material and on the training card.

Float trips that last overnight also require camping skills. Because Scouting emphasizes outdoor skills in many programs, only items specific to canoeing or kayaking are reviewed in the course material.

Prerequisites

1. Age, physical fitness, and training:

- a. Be 15 years old or older prior to training.
- b. Submit written evidence of physical fitness.
- c. Complete Safety Afloat training.

2. Swimming ability:

Complete the BSA swimmer test: Jump feetfirst into water over the head in depth. Level off and swim 75 yards in a strong manner using one or more of the following strokes: sidestroke, breaststroke, trudgen, or crawl; then swim 25 yards using an easy, resting backstroke. The 100 yards must be completed in one swim without stops and must include at least one sharp turn. After completing the swim, rest by floating.

Requirements

3. Personal safety skills:
 - a. Select a life jacket of appropriate size and demonstrate proper fit.
 - b. Demonstrate the feet-up floating position used if caught in a current.
 - c. Demonstrate H.E.L.P. and Huddle positions.
 - d. Capsize and swim a boat to shore.
4. Basic boating skills: Demonstrate the following maneuvers on calm water using standard stroke techniques:
 - a. Transport boat from rack or trailer to water's edge.
 - b. Safely board and launch the craft.
 - c. Travel in a straight line for 50 yards.
 - d. Stop the craft.
 - e. From the stop, move the boat sideways, first to the right, then to the left.
 - f. From the stop, pivot the boat to the right, then to the left.
 - g. Return to shore along a curved course demonstrating both left and right turns while under way.
 - h. Land, safely exit, and store the craft.
5. Group safety skills:
 - a. Throw a rescue bag, laying the line within 3 feet of an object 30 feet away.
 - b. Demonstrate a boat rescue of a swimmer.
 - c. Demonstrate an on-water boat-over-boat assist.
6. Correctly answer 80 percent of the questions on the Paddle Craft Safety written exam covering Safety Afloat, trip preparation, emergency action plans, and basic boating knowledge. Review any incomplete or incorrect answers.

*Skills may be demonstrated either tandem in a canoe or solo in a kayak. If a tandem canoe is used, each participant must demonstrate the maneuvers from both bow and stern positions.

BSA Aquatics Supervision: Paddle Craft Safety—River

Purpose

The Basic Paddle Craft Safety training provides an introduction to flat water canoeing and/or kayaking. The River modules extend that introduction to moving water. Any unit planning river trips in canoes or kayaks should be well served by leaders who complete those modules. Details are provided in the same Instructor Guide used for the basic modules.

Requirements

1. Prerequisites:
 - a. Submit written evidence of physical fitness.
 - b. Have current Safety Afloat training.
 - c. Have current training in Aquatics Supervision: Paddle Craft Safety—Basic for the appropriate craft.
 - d. Demonstrate or provide evidence of current ability to complete the 100-yard BSA swimmer classification.
2. View and discuss the ACA/BSA video “Reading the Rhythms of Rivers and Rapids.”
3. Do the following during an instructor-led canoe or kayak trip of at least three miles down a flowing river with Class I or Class II features, including standing waves, a downstream V, and a large eddy. A segment that includes isolated Class II+ or Class III rapids that can be portaged is appropriate, but not necessary. Features and water levels must be consistent with the safe performance of the requirements.
 - a. Transport boat from trailer or carrier to river’s edge. Safely board and launch the boat into a current.
 - b. Review the effect of basic flat-water strokes in moving water, demonstrating the ability to stay parallel with the current.
 - c. Demonstrate knowledge of river signals to communicate with other boats.
 - d. Perform a controlled swamp in a current, safely exit the craft, and guide it to shore.
 - e. Swim feetfirst in a current without a boat and catch a throw bag deployed from shore.
 - f. Successfully deploy a throw bag to a person fulfilling requirement 3E.
 - g. If canoeing, demonstrate a cross draw stroke. If kayaking, demonstrate a low brace.
 - h. Demonstrate ability to cross the current using a front ferry.
 - i. Demonstrate an eddy turn.
 - j. Demonstrate peel out of an eddy.
 - k. Stop above a rapid indicated on a river map. Scout the rapid to determine how best to run the rapid and then run it.
 - l. Stop above a hole, low-head dam, or other feature indicated on a river map. Scout and portage the feature, even if it can be safely run.
 - m. Land, safely exit, and load the boat for transport.
4. Write a float plan for a troop, crew, or ship covering the stretch of river used for training.



BSA Lifeguard

BSA Lifeguard requirements and support materials are revised regularly. Those interested in the training should consult the BSA Lifeguard Instructor Manual for changes that keep the program in line with the industry's evolving standards for professional lifeguards.

Participants in BSA Lifeguard training are required to complete all the sessions outlined in the instructor manual, which is available for free download at www.scouting.org/filestore/pdf/BSA_Lifeguard_Instructor_Manual-2017.pdf.

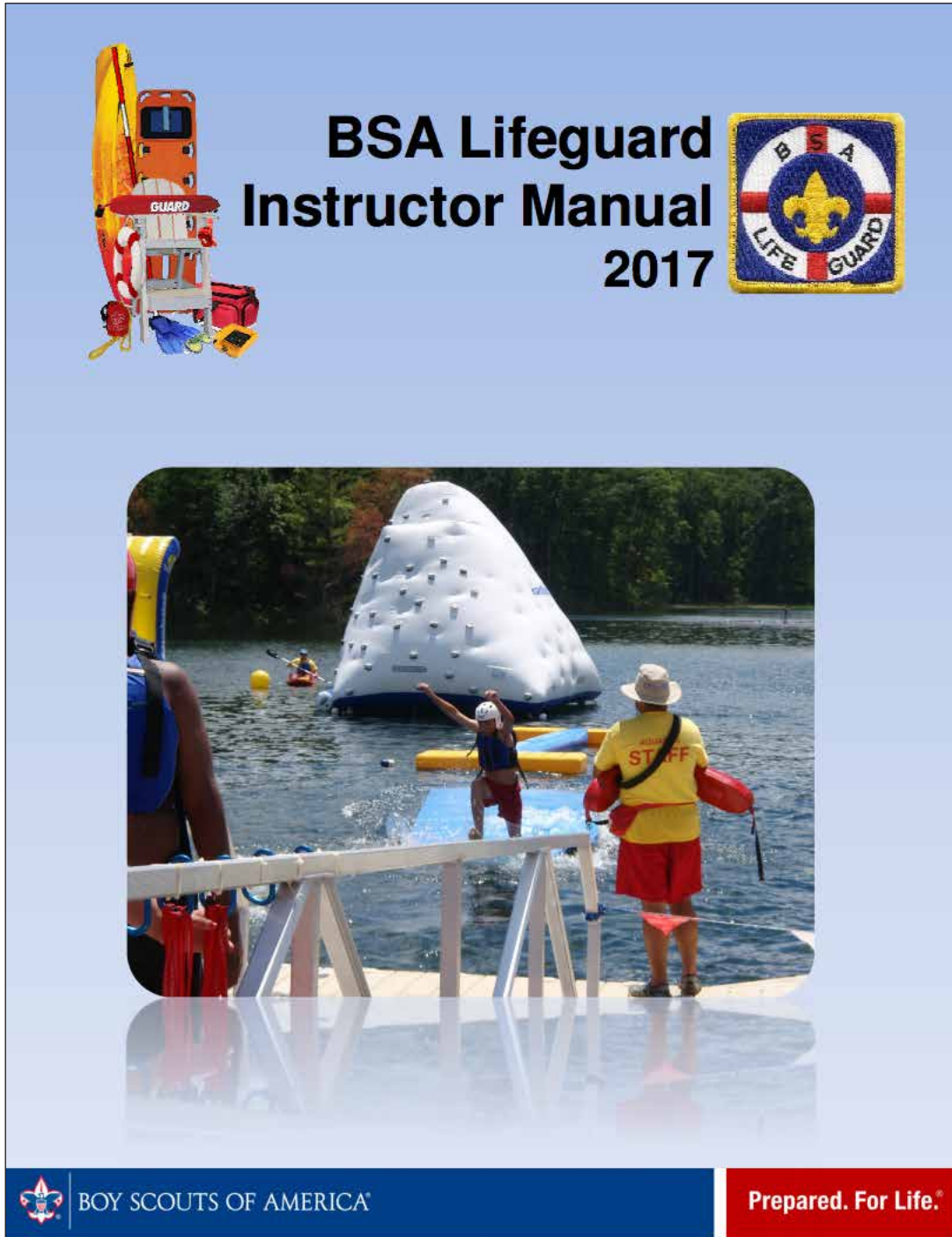

**BSA Lifeguard
Instructor Manual
2017**

BOY SCOUTS OF AMERICA

Prepared. For Life.®



BOY SCOUTS OF AMERICA
1325 West Walnut Hill Lane
P.O. Box 152079
Irving, Texas 75015-2079
www.scouting.org

SKU 648224



7 30176 34968 8
34346 2018 Printing